

ORDINANCE NO. 599-2021

Updating Kitsap County's stormwater management Ordinance, Title 12 KCC, "Stormwater Drainage" and adopting a new Kitsap County Stormwater Design Manual

BE IT ORDAINED:

Section 1. General Findings. The Kitsap County Board of Commissioners (Board) makes the following findings:

1. Kitsap County is subject to the requirements of the United States Clean Water Act, 33 USC 1251 *et seq.*, the Washington State Clean Water Act, chapter 90.48 RCW, and the National Pollutant Discharge Elimination System (NPDES) permit program. These, in part, require the County to develop a stormwater management program.
2. Kitsap County is also subject to the Growth Management Act (GMA) and RCW 36.70A.130(1) mandates that Kitsap County's Comprehensive Plan and development regulations be subject to continuing review and evaluation.
3. On July 1, 2019, the Washington State Department of Ecology (Ecology) reissued the NPDES Phase II Municipal Stormwater Permit (Permit) to be effective on August 1, 2019 and to expire on July 31, 2024. This Permit covers at least 80 cities and portions of six counties, including Kitsap County, and regulates discharges from small municipal separate storm sewer systems (MS4) owned or operated by these jurisdictions.
4. Compliance with the Permit is required to comply with the federal and state Clean Water Acts. Further, stormwater runoff and associated development codes must comply with Ecology rules to prevent and control impacts of stormwater runoff from new development, redevelopment and construction activities.
5. The Permit also requires that Phase II jurisdictions undertake a number of programs to address water pollution, including public education and outreach; public involvement and participation; the detection and elimination of illicit discharges into and connections to County stormwater systems; the regulation of runoff from new development, redevelopment and construction sites; and the operation and maintenance of stormwater systems. The County has implemented or is working toward the implementation of a variety of activities to satisfy these requirements within the timeframes established by the Permit and this ordinance is just one of the many activities intended to carry out the requirements within the Permit.
6. In connection with the NPDES Phase II permit reissuance, Ecology updated its rules in the Stormwater Management Manual for Western Washington in 2019. This update included substantial reorganization and some changes to minimum requirements and design requirements. The design criteria outlined by Ecology are largely based on industry

standards and guidance approved by Ecology, including the Low Impact Design Technical Guidance Manual for Puget Sound, the WSDOT Highway Runoff Manual, and the WSDOT Hydraulics Manual.

7. Ecology's update required Kitsap County to review and update, where appropriate, the Kitsap County Stormwater Design Manual and associated Kitsap County Codes.

Section 2. General Procedural Findings. The Board makes the following findings regarding process and public participation:

1. In 2019, the Departments of Community Development and Public Works, with the assistance of a consultant team, identified specific sections of the County's Stormwater Design Manual and the County's Stormwater Code that needed updating for consistency and alignment to the NPDES Phase II permit requirements and Ecology's updated 2019 Stormwater Management Manual for Western Washington.
2. A first draft of proposed revisions to the Kitsap County Stormwater Design Manual was published for public review and comment on March 2, 2020 (First Draft). Public comments were solicited through April 20, 2020, allowing seven (7) weeks of public review for the initial draft proposal. Solicitation occurred by reaching out directly to the press and to the public through GovDelivery and social media. A matrix summarizing changes from the 2016 Stormwater Design Manual to the First Draft proposal was also made available.
3. On April 20, 2020, a workshop with Kitsap Building Association (KBA) was held to discuss the proposed technical changes in the First Draft and to seek feedback.
4. On May 6, 2020 the Department of Community Development submitted to the Washington State Department of Commerce its Notice of Intent to Adopt Amendments to the Stormwater Design Manual and Stormwater Code, as required under RCW 36.70A.106, as well as a request for Expedited Review. On the same day, Commerce acknowledged receipt and granted Expedited Review. No comments were received from Commerce or other state agencies.
5. On May 19, 2020, the Kitsap County Planning Commission held a regularly scheduled and properly noticed work-study session to review the First Draft as well as the underlying federal, state and local requirements.
6. On June 9, 2020, the Departments of Community Development and Public Works released a Second Draft of proposed changes to the Stormwater Design Manual along with proposed revisions to Kitsap County Code Title 12 "Storm water Drainage."
7. On June 16, 2020, the Kitsap County Planning Commission held a regularly scheduled and properly noticed work-study session to review the Second Draft of the Stormwater Design Manual, the Title 12 revisions, and underlying requirements to the proposed update. An

updated Key Changes Matrix was provided (highlighting the changes between the 2016 Stormwater Design Manual, the First Draft, the Second Draft, and Title 12), as well as a Public Comment Matrix.

8. On June 20, 2020, Kitsap County Department of Community Development issued a State Environmental Policy Act (SEPA) Determination of Non-Significance (DNS) on the proposed Second Draft proposal to the Stormwater Design Manual and Title 12 revisions. An associated 14-day comment and appeal period closed on July 6, 2020. No comments or appeals were received.
9. On June 26, 2020, Kitsap County Department of Community Development issued a Staff Report and Recommendation regarding the proposed updates to Title 12 and the 2016 Kitsap County Stormwater Design Manual.
10. On July 7, 2020, following effective and timely legal notice, the Kitsap County Planning Commission held a public hearing to accept verbal and written testimony on the proposed amendments to Kitsap County Code Title 12 and the Second Draft of the Stormwater Design Manual. The written comment period was extended to July 13, 2020, 4:30 pm.
11. On July 21, 2020, the Kitsap County Planning Commission held a regularly scheduled and properly noticed meeting to deliberate and make recommendations through Findings of Fact on the proposed amendments to Kitsap County Code Title 12 and the Second Draft of the Stormwater Design Manual with its associated corrections memo. The Planning Commission voted 6-0 to approve the proposed amendments and subsequently approved the Findings of Fact 6-0.
12. On August 3, 2020, the Planning Commission Findings of Fact were forwarded to the Board of County Commissioners.
13. On August 3, 2020, the Board of County Commissioners held a regularly scheduled and properly noticed work-study session to review the Planning Commission Findings of Fact, to review, the proposed revisions to the Kitsap County Stormwater Design Manual and Title 12, and to review public comments received during the Planning Commission process.
14. On September 14, 2020, following effective and timely legal notice, the Kitsap County Board of Commissioners held a public hearing to accept verbal and written testimony on the proposed amendments to Kitsap County Code Title 12 and the of the Stormwater Design Manual. Written testimony was accepted until the close of business on September 16, 2020.
15. On September 21, 2020, the Kitsap County Board of Commissioners held a regularly scheduled and properly noticed meeting to consider and deliberate on the proposed amendments to Kitsap County Code Title 12 and the Stormwater Design Manual, the findings and recommendations of the Planning Commission, the analysis in the Staff

Report, the testimony provided, and all other documents in the record.

16. On October 19, 2020 the Kitsap County Board of Commissioners held a regularly scheduled and properly noticed meeting to continue deliberations on the proposed amendments to Kitsap County Code Title 12 and the Stormwater Design Manual.
17. On June 28, 2021, the Kitsap County Board of Commissioners held a regularly scheduled and properly noticed meeting to continue deliberations and make a decision on the proposed amendments to Kitsap County Code Title 12 and the Stormwater Design Manual.

Section 3. General Substantive Findings. The Kitsap County Board of Commissioners makes the following substantive findings:

1. This ordinance was developed according to and is compliant with the procedural and substantive requirements of the Growth Management Act, the County-wide Planning Policies, the Kitsap County Comprehensive Plan and associated documents.
2. This ordinance is consistent and compliant with the National Pollutant Discharge Elimination System (NPDES) Phase II Permit for Western Washington (Permit).
3. Within the bounds of the Permit, this ordinance reflects current local circumstances and is necessary to protect the general public health, safety and welfare of the citizens of Kitsap County.

Section 4. Kitsap County's Stormwater Design Manual, last adopted by Ordinance 540-2016, is *repealed* in its entirety, and replaced by the Stormwater Design Manual set forth in Attachment 1 hereto.

Section 5. Kitsap County Code Section 12.04.020, "Storm water management standards and specifications," last amended by Ordinance 540-2016, is amended as follows:

12.04.020 Storm water management standards and specifications.

The Kitsap County board of commissioners recognizes that storm water control technology is a developing and evolving science. In order to ensure that the latest and best technology is utilized in Kitsap County, these regulations include the Kitsap County Stormwater Design Manual (Kitsap manual) that is incorporated herein by this reference. ~~A copy of the Kitsap manual is available for inspection or purchase upon request.~~ The Kitsap manual may consist of one or more documents each of which may be amended as necessary to reflect changing conditions and technology. All requirements contained in the Kitsap manual, together with any amendments thereto, must be complied with as provided in Section 12.04.030.

Section 6. Kitsap County Code Section 12.08.050, "Bioretention facilities," last amended by

Ordinance 540-2016, is amended as follows:

12.08.050 Bioretention facilities.

“Bioretention facilities” means engineered facilities that treat storm water by passing it through a specified soil profile, and either retain or detain the treated storm water for flow attenuation. Refer to the Chapter 5 of Volume II of the Kitsap manual Stormwater Management Manual for Western Washington (Ecology Manual), Chapter 7 of Volume V for bioretention BMP types and design specifications.

Section 7. Kitsap County Code Section 12.08.085, “Comprehensive drainage plan,” last amended by Ordinance 540-2016, is amended as follows:

12.08.085 Comprehensive drainage plan.

“Comprehensive drainage plan” means a detailed analysis, adopted by the board, for a drainage basin which assesses the capabilities and needs for runoff accommodation due to various combinations of development, land use, structural and nonstructural management alternatives. The plan recommends the form, location and extent of flow control and runoff treatment~~storm water quantity and quality control~~ measures, which would satisfy legal constraints, water quality standards, and community standards, and identifies the institutional and funding requirements for plan implementation.

Section 8. Kitsap County Code Section 12.08.095, “Converted vegetation,” last amended by Ordinance 540-2016, is amended as follows:

12.08.095 Converted vegetation (areas).

“Converted vegetation (areas)” means surfaces on a project site where native vegetation, pasture, scrub/shrub, or unmaintained nonnative vegetation (e.g., Himalayan blackberry, Scotch broom) are converted to lawn or landscaped areas, or where native vegetation is converted to pasture.

Section 9. Kitsap County Code Section 12.08.160, “Ecology Manual,” last amended by Ordinance 540-2016, is amended as follows:

12.08.160 Ecology Manual.

“Ecology Manual” means the ~~2019~~2012 Stormwater Management Manual for Western Washington, ~~published~~amended in ~~July 2019~~December 2014.

Section 10. Kitsap County Code Section 12.08.165, “Effective impervious surface,” last amended by Ordinance 540-2016, is amended as follows:

12.08.165 Effective impervious surface.

“Effective impervious surface” means those impervious surfaces that are connected via sheet flow or discrete conveyance to a stormwater drainage system. Impervious surfaces are considered ineffective if: (1) the runoff is dispersed through at least one hundred feet of native vegetation in accordance with BMP T5.30 – “Full Dispersion” as described in Chapter 5 of Volume ~~II~~ of the Kitsap manual Ecology Manual; (2) residential roof runoff is infiltrated in accordance with downspout full infiltration systems in Chapter 5 of BMP T5.10A in Volume ~~III~~ of the Kitsap manual Ecology Manual; or (3) approved continuous runoff modeling methods indicate that the entire runoff file is infiltrated.

Section 11. Kitsap County Code Section 12.08.183, “Flow control best management practices (BMPs),” last amended by Ordinance 540-2016, is amended as follows:

12.08.183 Flow control best management practices (BMPs).

“Flow control best management practices (BMPs)” means strategies that control the volume rate, frequency, and flow duration of stormwater surface runoff. Flow control BMPs include, but are not limited to, detention ponds, detention tanks, and detention vaults.

Section 12. Kitsap County Code Section 12.08.200, “Geotechnical report and geological report,” last amended by Ordinance 540-2016, is amended as follows:

12.08.200 Geotechnical report and geological report.

“Geotechnical report” and “geological report” mean a study of potential site development impacts related to retention of natural vegetation, soil characteristics, geology, drainage, ground water discharge, and engineering recommendations related to slope and structural stability. The geotechnical report shall be prepared by, or in conjunction with, a geotechnical engineer meeting the minimum qualifications as defined by this title. Geological reports may contain the above information with the exception of engineering recommendations, and may be prepared by a geologist. “Geotechnical report” means a study of the effects of drainage and drainage facilities on soil characteristics, geology and ground water. A geotechnical engineer, ~~or~~ geologist or hydrogeologist shall prepare the geotechnical report.

Section 13. Kitsap County Code Section 12.08.240, “Illicit discharge,” last amended by Ordinance 540-2016, is amended as follows:

12.08.240 Illicit discharge.

“Illicit discharge” means all non-storm water discharges to storm water drainage systems that cause or contribute to a violation of state water quality, sediment quality or ground water quality standards, including, but not limited to, sanitary sewer connections, industrial process

water, interior floor drains, and gray water systems. The following shall not be considered illicit discharges unless the director determines that the type of discharge, whether singly or in combination with others, is causing or is likely to cause pollution of surface water or ground water:

- (A) Diverted stream flows.
- (B) Rising ground waters.
- (C) Uncontaminated ground water infiltration (as defined at 40 CFR 35.2005(20)).
- (D) Uncontaminated pumped ground water.
- (E) Foundation drains.
- (F) Air conditioning condensation.
- (G) Irrigation water from agricultural sources that is commingled with urban storm water.
- (H) Springs.
- (I) Uncontaminated water from crawl space pumps.
- (J) Footing drains.
- (K) Flows from riparian habitats and wetlands.
- (L) Non-storm water discharges covered by and compliant with another NPDES permit.
- (M) Discharges from emergency fire-fighting activities.
- (N) Discharges from potable water sources, including water line flushing, hyperchlorinated water line flushing, fire hydrant system flushing, and pipeline hydrostatic test water so long as the discharges are dechlorinated to a concentration of 0.1 ppm or less, pH-adjusted, if necessary, and volumetrically and velocity controlled to prevent resuspension of sediments in storm water drainage systems.
- (O) Discharges from lawn watering and other irrigation runoff.
- (P) Dechlorinated swimming pool, spa, and hot tub discharges so long as the discharges shall be dechlorinated to a concentration of 0.1 ppm or less, pH-adjusted and reoxygenized if necessary, volumetrically and velocity controlled to prevent resuspension of sediments in the MS4. Discharges shall be thermally controlled to prevent an increase in temperature of the receiving water. Swimming pool cleaning wastewater and filter backwash shall not be discharged to storm water drainage systems.
- (Q) Street and sidewalk wash water, water used to control dust, and routine external building wash down that does not use detergents. At active construction sites, street sweeping must be performed prior to washing the street.

Section 14. Kitsap County Code Section 12.08.280, “Low impact development (LID),” last amended by Ordinance 540-2016, is amended as follows:

12.08.280 Low impact development (LID).

“Low impact development (LID)” means a storm water and land use management strategy that strives to mimic pre-disturbance hydrologic processes of infiltration, filtration, storage, evaporation and transpiration by emphasizing conservation, use of on-site natural features, site planning, and distributed storm water management practices that are integrated into a project design. LID is also known as green storm water infrastructure (GSI) or green storm water solutions (GSS). LID is the preferred term used by the county.

Section 15. Kitsap County Code Section 12.08.285, “Low impact development (LID) best management practices (BMPs),” last amended by Ordinance 540-2016, is amended as follows:

12.08.285 Low impact development (LID) best management practices (BMPs).

“Low impact development (LID) best management practices (BMPs)” means distributed storm water management practices, integrated into a project design, that emphasize pre-disturbance hydrologic processes of infiltration, filtration, storage, evaporation and transpiration. LID BMPs include, but are not limited to, bioretention, rain gardens, permeable pavements, ~~roof-downspout~~ full infiltration controls, downspout dispersion systems, perforated stub-out connections, full dispersion, post-construction soil quality and depth, minimal~~minimum~~ excavation foundations, vegetated roofs, and rainwater harvesting~~water reuse~~.

Section 16. Kitsap County Code Section 12.08.290, “Maintenance,” last amended by Ordinance 540-2016, is amended as follows:

12.08.290 Maintenance.

“Maintenance” means repair and maintenance and includes activities conducted on currently serviceable structures, facilities, and equipment that involves no expansion or use beyond that previously existing and approved and results in no significant adverse hydrologic impact. It includes those usual activities taken to prevent a decline, lapse, or cessation in the use of structures and systems. Those usual activities may include replacement of dysfunctional facilities, including cases where environmental permits require replacing an existing structure with a different type of structure, as long as the functioning characteristics of the original structure are not changed. One example is the replacement of a collapsed, fish blocking, round culvert with a new box culvert under the same span, or width, of roadway. In regard to storm water facilities, maintenance includes assessment to ensure ongoing proper operation, removal of built up pollutants (i.e., sediments), replacement of failed or failing treatment media, and other actions taken to correct defects as identified in the BMP design guidance~~maintenance standards of Chapter 4, within the Kitsap manual~~ Volume V of the Ecology Manual. See also pavement maintenance exemptions in Section 12.10.040(4).

NEW SECTION. Section 17. A new section is added to Chapter 12.08 Kitsap County Code, “Definitions,” as follows:

12.08.318 New impervious surface.

“New impervious surface” means a surface that is:

- changed from a pervious surface to an impervious surface (e.g. resurfacing by upgrading from dirt to gravel, a bituminous surface treatment (“chip seal”), asphalt, concrete, or an impervious structure); or
- upgraded from gravel to chip seal, asphalt, concrete, or an impervious structure; or
- upgraded from chip seal to asphalt, concrete, or an impervious structure.

Note that if asphalt or concrete has been overlaid by a chip seal, the existing condition should be considered as asphalt or concrete.

Section 18. Kitsap County Code Section 12.08.360, “Pollution-generating impervious surface (PGIS),” last amended by Ordinance 540-2016, is amended as follows:

12.08.360 Pollution-generating impervious surface (PGIS).

“Pollution-generating impervious surface (PGIS)” means those impervious surfaces considered to be a significant source of pollutants in storm water runoff. Such surfaces include those ~~which~~ that are subject to any of the following: vehicular use; industrial activities (as further defined in the glossary of the Ecology Manual); ~~or~~ storage of erodible or leachable materials, wastes, or chemicals, and which receive direct rainfall or the run-on or blow-in of rainfall. Erodeable or leachable materials, wastes, or chemicals are those substances which, when exposed to rainfall, measurably alter the physical or chemical characteristics of the rainfall runoff. Examples include erodible soils that are stockpiled, uncovered process wastes, manure, fertilizers, oily substances, ashes, kiln dust, and garbage dumpster leakage; ~~metal roofs are also considered to be PGIS unless they are coated with an inert, nonleachable material (e.g., baked-on enamel coating);~~ or roofs that are subject to venting significant amounts of dusts, mites, or fumes from manufacturing, commercial, or other indoor activities. A surface, whether paved or not, shall be considered subject to vehicular use if it is regularly used by motor vehicles. The following are considered regularly used surfaces: roads, unvegetated road shoulders, bike lanes within the traveled lane of a roadway, driveways, parking lots, unfenced fire lanes, vehicular equipment storage yards, and airport runways. The following are not considered regularly used surfaces: paved bicycle pathways separated from and not subject to drainage from roads for motor vehicles, fenced fire lanes, and infrequently used maintenance access roads.

Section 19. Kitsap County Code Section 12.08.365, “Pollution-generating pervious surfaces (PGPS),” last amended by Ordinance 540-2016, is amended as follows:

12.08.365 Pollution-generating pervious surfaces (PGPS).

“Pollution-generating pervious surfaces (PGPS)” means any ~~pervious nonhard~~ surface subject to any of the following: vehicular use, industrial activities (as further defined in the glossary of the Ecology Manual); ~~or~~ storage of erodible or leachable materials, wastes, or chemicals, and

that receive direct rainfall or run-on or blow-in of rainfall; use of pesticides and fertilizers; or loss of soil. Typical PGPS include lawns, and landscaped areas including: golf courses, parks, cemeteries, and sports fields (natural and artificial turf).

NEW SECTION. Section 20. A new section is added to Chapter 12.08 Kitsap County Code, "Definitions," as follows:

12.08.372 Project.

"Project" means any proposed action to alter or develop a site.

Section 21. Kitsap County Code Section 12.08.395, "Redevelopment," last amended by Ordinance 540-2016, is amended as follows:

12.08.395 Redevelopment.

"Redevelopment" means development on a site that is already substantially developed (i.e., has thirty-five percent or more of existing ~~hard~~^{hard impervious} surface coverage) by one or more of the following: the creation or addition of hard surfaces; the expansion of a building footprint or addition or replacement of a structure; structural development including construction, installation or expansion of a building or other structure; replacement of hard surface that is not part of a routine maintenance activity; and land disturbing activities.

Section 22. Kitsap County Code Section 12.08.450, "Soils investigation report," last amended by Ordinance 540-2016, is amended as follows:

12.08.450 ~~Soils investigation report.~~

~~"Soils investigation report"~~ means a study of soils on a subject property with the primary purpose of characterizing and describing the engineering properties of soils. The soils investigation report shall be prepared by a ~~qualified soils-~~licensed professional ~~engineer, or geologist,~~ who shall be directly involved in the soil characterization either by performing the investigation or by directly supervising employees.

Section 23. Kitsap County Code Section 12.08.455, last amended by Ordinance 540-2016, is hereby repealed.

Section 24. Kitsap County Code Section 12.08.460, "Source control BMP," last amended by Ordinance 540-2016, is amended as follows:

12.08.460 Source control BMP.

"Source control BMP" means a structure or operation that is intended to prevent pollutants

from coming into contact with storm water through physical separation of areas or careful management of activities that are sources of pollutants. The Ecology Manual separates source control BMPs into two types. Structural source control BMPs are physical, structural, or mechanical devices, or facilities that are intended to prevent pollutants from entering storm water. Operational BMPs are nonstructural practices that prevent or reduce pollutants from entering storm water. See Chapter 3 of Volume III of the Kitsap manual Ecology Manual for details.

Section 25. Kitsap County Code Section 12.08.475, “Stormwater or storm water,” last amended by Ordinance 540-2016, is amended as follows:

12.08.475 Stormwater or storm water.

“Stormwater” or “storm water” means the ~~surface water runoff that results from all natural forms of precipitation~~ during and following precipitation and snowmelt events, including surface runoff, drainage or interflow.

Section 26. Kitsap County Code Section 12.08.480, “Storm water facility or storm water control facility,” last amended by Ordinance 540-2016, is amended as follows:

12.08.480 Storm water facility or storm water control facility.

“Storm water facility” or “storm water control facility” means a component of a manmade drainage feature, or features, designed or constructed to perform a particular function or multiple functions, including, but not limited to, pipes, swales, bioretention facilities, ditches, culverts, street gutters, detention basins, retention basins, wetponds, constructed wetlands, infiltration devices, catch basins, oil/water separators and sediment basins. Storm water facilities shall not include building gutters, downspouts and drains serving one single-family residence. These are also known as or sometimes referred to as BMPs.

Section 27. Kitsap County Code Section 12.08.495, “Storm water system,” last amended by Ordinance 540-2016, is amended as follows:

12.08.495 Storm water system.

“Storm water system” means all natural and manmade systems which function together or independently to collect, store, purify, discharge and convey storm water. Included are all storm water best management practices/facilities as well as natural systems such as streams and creeks and all natural systems which convey, store, infiltrate or divert storm water.

Section 28. Kitsap County Code Section 12.08.505, “Treatment best management practices (BMPs)” is amended and renumbered as follows:

12.08.407 Runoff tTreatment best management practices (BMPs).

“Runoff treatment best management practices (BMPs)” means strategies to reduce levels of pollutant loads. Runoff treatment BMPs include simple gravity settling of particulate pollutants, centrifugal separation, filtration, biological uptake, and media or soil absorption. Runoff treatment BMPs include, but are not limited to, permeable pavement systems, wetponds, oil/water separators, and stormwater treatment wetlands.

NEW SECTION. Section 29. A New Section added to Chapter 12.08 Kitsap County Code, “Definitions,” as follows

12.08.505 Threshold discharge area (TDA).

An area within a project site draining to a single natural discharge location or multiple natural discharge locations that combine within one-quarter mile downstream (as determined by the shortest flowpath) The Kitsap manual contains a figure that illustrates this definition. The purpose of this definition is to clarify how the thresholds of the Kitsap manual are applied to project sites with multiple discharge points.

Section 30. Kitsap County Code Section 12.10.030, “Site development activity permits required,” last amended by Ordinance 540-2016, is amended as follows:

12.10.30 Site development activity permits required.

A site development activity permit, issued by the Kitsap County department of community development, shall be required for any of the following activities:

- (1) Site development or redevelopment activities that meet the thresholds requiring minimum requirements Nos. 1 through 9 to be met, as indicated by Figures ~~I-4.12.4.1~~ and ~~I-4.22.4.2~~ in Section 12.20.010;
- (2) Site development or redevelopment activities that require connection to a public storm water drainage system, except those actions undertaken by the Kitsap County public works department;
- (3) Grading activities that result in the movement of one hundred fifty cubic yards or more of earth;
- (4) Grading activities that will result in a temporary or permanent slope having a steepness exceeding three to one (three feet horizontal to one foot vertical) and having a total slope height, measured vertically from toe of slope to top of slope, exceeding five feet;
- (5) Grading activities that include the construction of embankment berms which will result in the impoundment of water to a depth exceeding eighteen inches and/or with a maximum volume exceeding two thousand five hundred cubic feet of water;
- (6) Grading activities that will result in the diversion of existing drainage courses, both natural and manmade, from their natural point of entry or exit from the grading site;
- (7) Any land clearing or grading on slopes steeper than thirty percent, or within the mandatory setback of a steep slope, wetland, stream, lake, or Puget Sound, as established by other titles of this code.

No site development activity, including land clearing, grading or other construction activity as described in this title, shall occur until a site development activity permit has been issued, nor shall said site development activity continue without a site development activity permit in force.

Section 31. Kitsap County Code Section 12.10.040, "Exemptions," last amended by Ordinance 540-2016, is amended as follows:

12.10.040 Exemptions.

The following activities shall not require a site development activity permit:

- (1) Commercial Agriculture. Commercial agriculture practices involving working the land for production are generally exempt. However, the conversion from timber land to agriculture and the construction of impervious surfaces are not exempt.
- (2) Grading. Grading activities described in Section 12.16.070 are exempt from the provisions of this chapter.
- (3) Forest Practices. Forest practices regulated under WAC Title 222, except for Class IV general forest practices that are conversions from timber land to other uses, are exempt from the provisions of the minimum requirements.
- (4) Road Maintenance. The following road maintenance practices are exempt from minimum requirements: pothole and square cut patching, overlaying existing asphalt or concrete pavement with asphalt or concrete without expanding the area of coverage, shoulder grading, reshaping/regrading drainage systems, crack sealing, resurfacing with in-kind material without expanding the road prism, pavement preservation activities that do not expand the road prism, and vegetation maintenance.

The following road maintenance practices are exempt only outside a census-defined urban area or an urban growth area, but are not exempt when within a census-defined urban area or an urban growth area.

- (A) Removing and replacing an asphalt or concrete pavement ~~a paved surface~~ to base course or lower, or repairing the roadway base. These are considered replaced hard surfaces. If impervious surfaces are not expanded, the minimum requirements Nos. 1 through 5 of the Ecology Manual apply. However, in most cases, only minimum requirement No. 2, construction storm water pollution prevention, will be germane.
- (B) Extending the pavement edge without increasing the size of the road prism, or paving graveled shoulders. These are considered new hard~~impervious~~ surfaces and are subject to the minimum requirements that are triggered when the thresholds identified for redevelopment projects are met.
- (C) Resurfacing by upgrading from dirt to gravel, ~~asphalt, or concrete; upgrading from gravel to asphalt or concrete; or upgrading from a bituminous surface treatment ("chip seal"), to asphalt, or concrete; upgrading from gravel to chip seal, asphalt, or concrete; or upgrading from chip seal to asphalt or concrete.~~ These are considered new impervious surfaces and are subject to the minimum requirements that are triggered when the thresholds identified for redevelopment projects are met.
- (5) Underground Utilities. Underground utility projects that replace the ground surface with

in-kind material or materials with similar runoff characteristics are only subject to minimum requirement No. 2, construction storm water pollution prevention.

Section 32. Kitsap County Code Section 12.10.060, "Professional engineer required," last amended by Ordinance 540-2016, is amended as follows:

12.10.060 Professional engineer required.

Unless otherwise required by Chapter 12.16, site development activity permit applications shall require the submittal of documents prepared by a qualified professional engineer when one of the following conditions exists:

- (1) Any land use, building, or development on real property that meets the thresholds requiring minimum requirements Nos. 1 through 9 to be met, as indicated by Figures ~~4.12.4.1~~ and ~~4.22.4.2~~ in Section 12.20.010; or
- (2) Any improvements within the boundaries of Kitsap County rights-of-way for which Kitsap County will ultimately assume responsibility for maintenance; or
- (3) Any site development activity that the director deems to be in the public's best interest to require that certain site development activity permit application submittal documents be prepared by a professional civil engineer.
- (4) Whenever an engineer is required by the Kitsap manual, including but not limited to design of conveyance, on-site storm water management, flow control, and runoff water quality treatment BMPs.

Section 33. Kitsap County Code Section 12.10.070, "Downstream analysis," last amended by Ordinance 540-2016, is amended as follows:

12.10.070 Downstream analysis.

The following projects shall conduct an analysis of downstream water quantity and quality impacts resulting from the project and shall provide for mitigation of these impacts:

- (1) All site development activity permit applications that meet any of the criteria listed in Section 12.10.060;
- (2) All large projects in accordance with the definition in Chapter 12.08;
- (3) All project sites located within critical drainage areas.
- (4) All projects that implement TDAs.

The analysis shall extend a minimum of one-fourth of a mile downstream from the project. The existing or potential impacts to be evaluated and mitigated shall include excessive sedimentation, erosion, discharges to ground water contributing or recharge zones, violations of water quality standards, and spills and discharges of priority pollutants. The downstream analysis shall include, along with other required submittal documents, an off-site drainage

analysis prepared by a qualified professional engineer in accordance with the requirements of the Kitsap manual.

Section 34. Kitsap County Code Section 12.10.080, “Geotechnical analysis,” last amended by Ordinance 540-2016, is amended as follows:

12.10.080 Geotechnical analysis.

All site development activity permit applications for development activities where grading or the construction of retention facilities, detention facilities, or other storm water facilities is proposed within two hundred feet of slopes steeper than thirty percent, or where the director deems that the proposed construction poses a potential hazard due to its proximity to a slope, shall, when required by the director, include a geotechnical analysis, prepared by a professional geotechnical engineer or licensed engineering geologist. The geotechnical analysis requirements vary depending on the amount of impervious area infiltrated on the project site and shall include a map of investigation and testing locations, soil characteristics, and depth to groundwater (if encountered), at a minimum. The geotechnical analysis may also require groundwater monitoring, characterization of infiltration receptor, groundwater mounding and seepage analysis,~~address the effects of~~ groundwater interception and infiltration, seepage, potential slip planes and changes in soil bearing strength.

Section 35. Kitsap County Code Section 12.16.040, “Abbreviated grading plan,” last amended by Ordinance 540-2016, is amended as follows:

12.16.040 Abbreviated grading plan.

Small grading projects that trigger minimum requirements Nos. 1 through 5 only, as indicated by Figures ~~I-4.12.4.1~~ and ~~I-4.22.4.2~~ in Section 12.20.010, may submit an abbreviated grading plan in lieu of an engineered grading plan, unless engineering is otherwise required.

Section 36. Kitsap County Code Section 12.20.010, “Minimum requirements for new and redevelopment projects,” last amended by Ordinance 540-2016, is amended as follows:

12.20.010 Minimum requirements for new and redevelopment projects.

Not all minimum requirements apply to every development or redevelopment project. The applicability varies depending on the project type and size. This section identifies thresholds that determine the applicability of the minimum requirements for new and redevelopment projects and is consistent with the Ecology Manual. Use the flow charts in Figures ~~I-4.12.4.1~~ and ~~I-4.22.4.2~~ to determine which of the minimum requirements apply. The minimum requirements are presented in Section 4.2, Volume I of the Kitsap manual.

(1) New Development. All new development shall be required to comply with minimum requirement No. 2.

(A) The following new development shall comply with minimum requirements Nos. 1 through 5 for the new and replaced hard surfaces and for the land disturbed when the development:

1. Results in two thousand square feet, or greater, of new plus replaced hard surface area; or
2. Has land disturbing activity of seven thousand square feet or greater.

(B) The following new development shall comply with minimum requirements Nos. 1 through 9 for the new and replaced hard surfaces and the converted vegetation areas when the development:

1. Includes grading involving the movement of five thousand cubic yards or more of material; or
2. For sites located inside census defined urban areas:
 - a. Results in five thousand square feet, or greater, of new plus replaced hard surface area, or
 - b. Converts three-quarters acre, or more, of vegetation to lawn or landscaped areas, or
 - c. Converts two and one-half acres, or more, of native vegetation to pasture.
3. For sites located outside census defined urban areas or UGAs, results in ten thousand square feet or more of new plus replaced hard surface area, or results in five percent or more of hard surface area covering the lot area (whichever is greater).

(2) Redevelopment. All redevelopment shall be required to comply with minimum requirement No. 2.

(A) The following redevelopment shall comply with minimum requirements Nos. 1 through 5 for the new and replaced hard surfaces and the land disturbed when the development:

1. Results in two thousand square feet, or more, of new plus replaced hard surface area, or
2. Has land disturbing activity of seven thousand square feet or greater.

(B) The following redevelopment shall comply with minimum requirements Nos. 1 through 9 for the new and replaced hard surfaces and converted vegetation areas when the development:

1. Includes grading involving the movement of five thousand cubic yards or more of material; or
2. For sites located inside census defined urban areas:
 - a. Adds five thousand square feet or more of new hard surfaces, or
 - b. Converts three-quarters acres, or more, of vegetation to lawn or landscaped areas, or
 - c. Converts two and one-half acres, or more, of native vegetation to pasture, or
 - d. Is a road-related project that adds five thousand square feet or more of new plus replaced hard surfaces, and:

ii. For commercial or industrial projects: the valuation of proposed improvements, including interior improvements, exceeds 50% of the assessed value of the existing project site improvements.

iii. For all other projects: the valuation of the proposed improvements, including interior improvements, exceeds 50% of the assessed value of the existing site improvements.

3. For sites located outside census defined urban areas or UGAs, adds ten thousand square feet or more of new hard surface area, or results in five percent or more of hard surface area covering the lot area (whichever is greater).

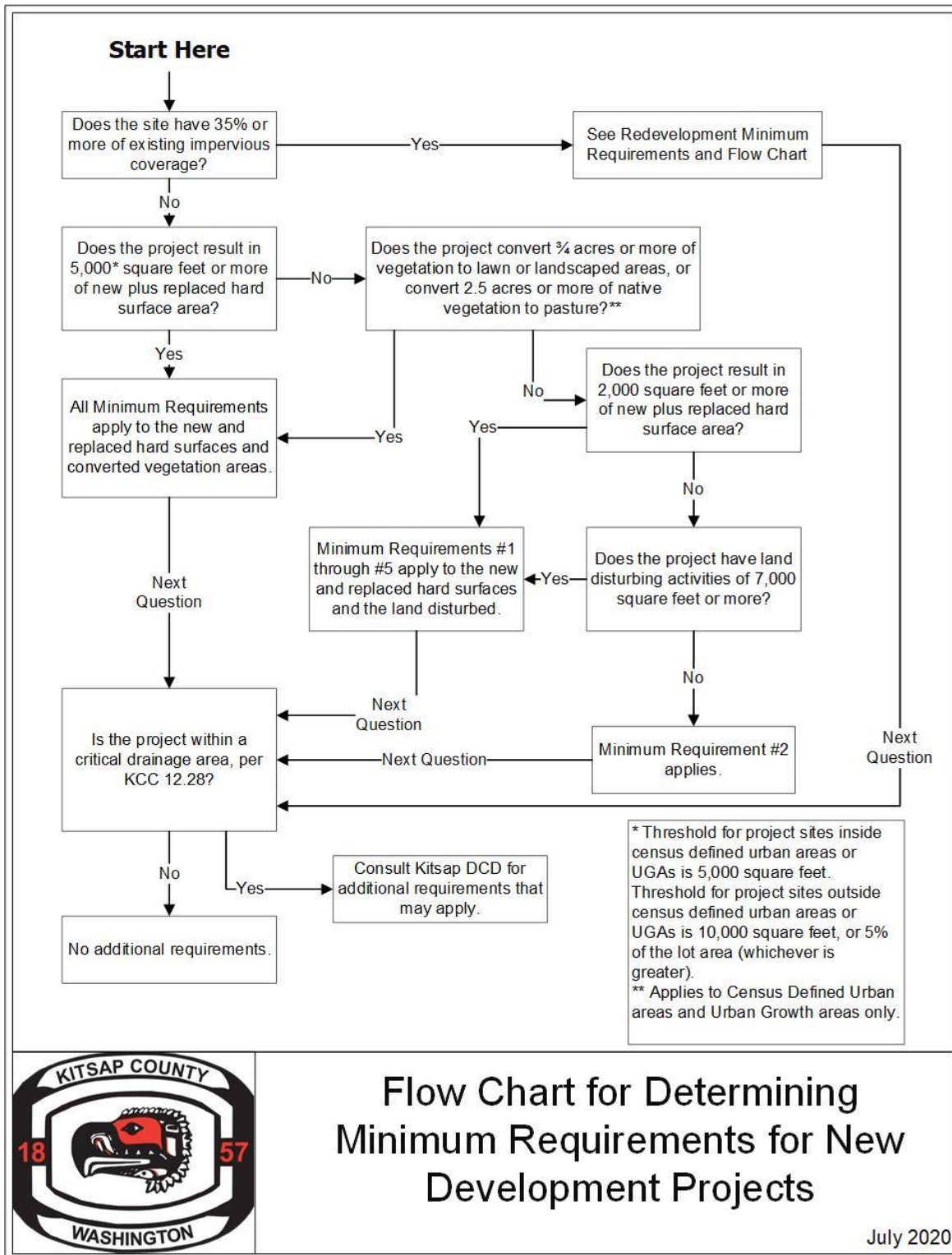


Figure I-4.12.4.1— Flow Chart for Determining Requirements for New Development

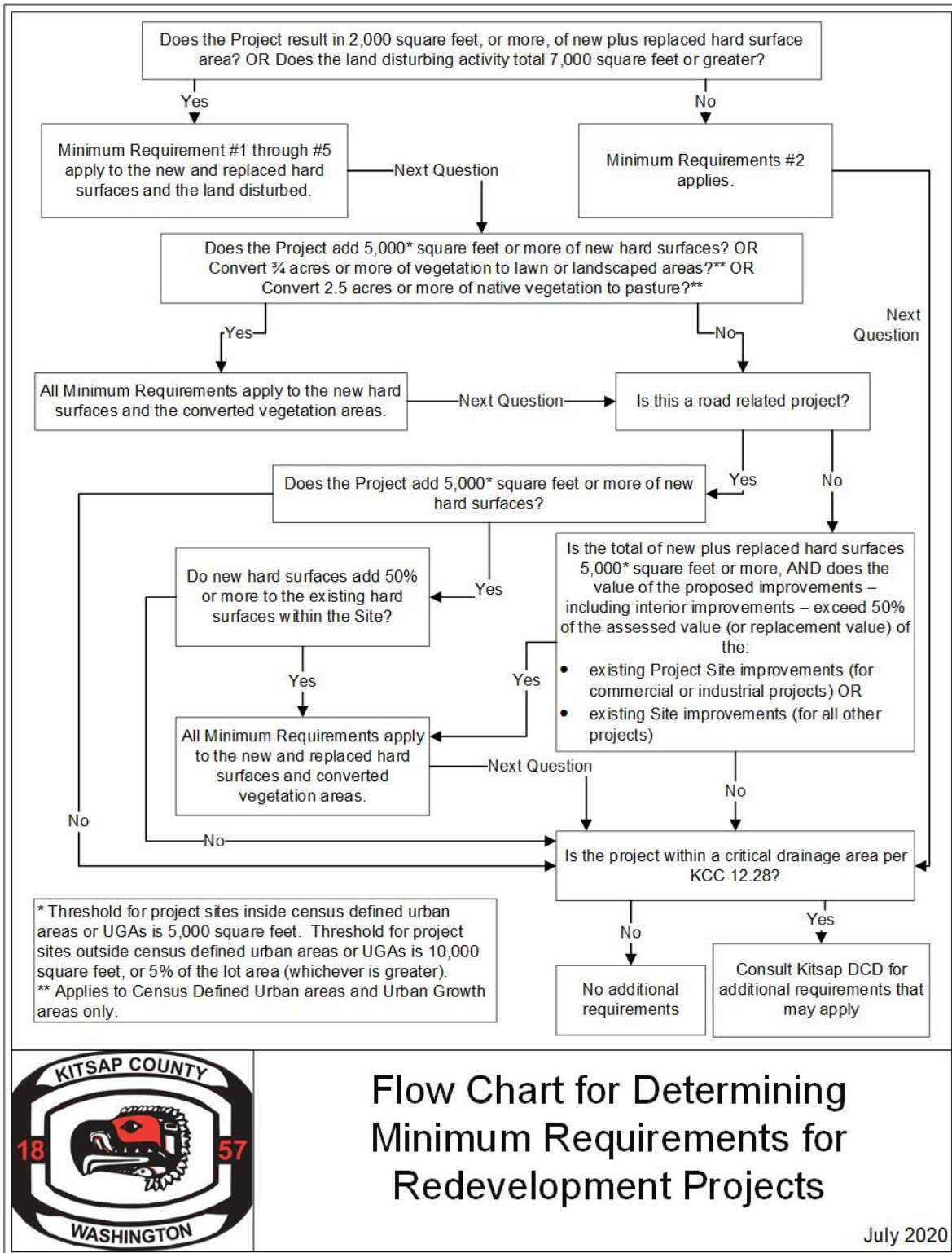


Figure I-4.22.4.2 – Flow Chart for Determining Requirements for Redevelopment

Section 37. Kitsap County Code Section 12.20.040, “Storm water management facility design requirements,” last amended by Ordinance 540-2016, is amended as follows:

12.20.040 Storm water management facility and best management practices (BMPs) design requirements.

Storm water conveyance facilities and on-site storm water management, flow control, and runoff water quality treatment best management practices (BMPs) shall be designed and used in accordance with the Kitsap manual.

Section 38. Kitsap County Code Section 12.20.060, “Emerging technologies,” last amended by Ordinance 540-2016, is amended as follows:

12.20.060 Manufactured treatment devices~~Emerging technologies.~~

Proprietary~~New~~ technologies shall be evaluated following Ecology’s technology assessment protocols (TAPE and CTAPE), as detailed in the Kitsap manual. Functionally equivalent BMPs approved by Ecology as equivalent to existing runoff water quality treatment technologies may be used.

Section 39. Kitsap County Code Section 12.20.100, “Easements, tracts and covenants,” last amended by Ordinance 540-2016, is amended as follows:

12.20.100 Easements, tracts and covenants.

- (1) Drainage easements shall be provided in a proposed development for all storm water conveyance systems that are not located in public rights-of-way. The drainage easements shall be granted to the parties responsible for providing ongoing maintenance of the systems. Drainage easements through structures are not permitted.
- (2) Storm water best management practices/facilities that are to be maintained by Kitsap County, together with maintenance access roads to the facilities, shall be located in the public right-of-way, in separate tracts to be dedicated to Kitsap County, or in drainage easements to be granted to Kitsap County. Kitsap County will not accept any dedication or maintenance obligations unless and until the conditions of Chapter 12.24 are met. Wording to this effect shall appear on the face of all final plats, and shall be contained in any covenants required for a development.
- (3) All runoff from impervious surfaces, roof drains and yard drains shall be directed so as not to adversely affect adjacent properties. Wording to this effect shall appear on the face of all final plats, and shall be contained in any covenants required for a development.

Section 40. Kitsap County Code Section 12.20.120, “Regional facilities,” last amended by Ordinance 540-2016, is amended as follows:

12.20.120 Regional facilities.

When the director has determined that the public would benefit by the establishment of a

regional storm water facility that would serve as an alternative to the construction of separate on-site drainage facilities, the director may recommend to the board that a regional storm water facility be constructed which would serve more than one development in providing flow control~~storm water quantity~~ and/or runoff treatment~~quality control~~. In the event that a regional storm water facility is required by the board, such a regional storm water facility shall be located outside of fish-bearing streams, unless otherwise accepted by the Washington State Department of Fish and Wildlife. All future developments constructed on lands designated by the board to be served by the regional facility shall, at the time of issuance of a site development activity permit for a development, be required to contribute a fair share to the cost of land purchase, design and construction of the regional facility. In the event that a proposed regional storm water facility is not yet in operation at the time of completion of construction of a development that is to be served by the regional facility, the applicant for the development shall be required to provide temporary storm water flow control~~quantity~~ and runoff treatment best management practices (BMPs)~~quality controls~~. Temporary flow control~~quantity~~ and runoff treatment BMPs~~quality controls~~ may be constructed in temporary easements, rather than in separate tracts.

Section 41. Kitsap County Code Section 12.20.130, “Watershed planning,” last amended by Ordinance 540-2016, is amended as follows:

12.20.130 Watershed planning.

An adopted and implemented basin plan tailored to a specific basin may be used to develop requirements for source control, runoff~~storm water~~ treatment, flow control, wetlands and water quality sensitive areas. Adopted and implemented watershed-scale basin plans may be used to modify any or all of the minimum requirements for ~~storm water quantity or quality control~~flow control or runoff treatment addressed in this title; provided, that the level of protection for surface or ~~ground water~~groundwater achieved by the basin plan will equal or exceed that which would otherwise be achieved by implementation of the provisions of this title in the absence of a basin plan. Watershed plans shall evaluate and include, as necessary, retrofitting of BMPs for existing development and/or redevelopment in order to achieve watershed-wide pollutant reduction goals. Standards developed from watershed plans shall not modify any of the above requirements until the watershed plan is formally adopted by the State Department of Ecology and Kitsap County and fully implemented by Kitsap County.

Section 42. Kitsap County Code Section 12.24.010, “Maintenance of storm water facilities by owners,” last amended by Ordinance 540-2016, is amended as follows:

12.24.010 Maintenance of storm water best management practices (BMPs)/facilities by owners.

(1) Any person or persons holding title to a nonresidential property for which storm water facilities and BMPs have been required by Kitsap County shall be responsible for the continual operation, maintenance and repair of the storm water facilities and BMPs in accordance with

the provisions of this title.

(2) For privately maintained storm water facilities, the maintenance requirements specified in this title, including the Kitsap manual, shall be enforced against the owner(s) of the subject property served by the storm water facility.

(3) Storm water maintenance shall be performed in accordance with the Kitsap manual.

Section 43. Kitsap County Code Section 12.24.020, "Maintenance covenant required for privately maintained drainage facilities," last amended by Ordinance 540-2016, is amended as follows:

12.24.020 Maintenance covenant required for privately maintained ~~drainage~~best management practices (BMPs)/facilities.

(1) Prior to the use of a development constructed under a site development activity permit, the owner shall record a maintenance covenant which guarantees Kitsap County that the storm water BMPs/facilities shall be properly operated, maintained and inspected, and which gives Kitsap County the authority to enter and inspect the BMP/facility, and to take any necessary enforcement action as per Chapter 12.32. The restrictions set forth in such covenant shall be included in any instrument of conveyance of the subject property and shall be recorded with the Kitsap County auditor.

(2) The director may require the owners of existing storm water BMPs/facilities for which Kitsap County has not previously accepted operation and maintenance responsibility to record a maintenance covenant or to request that Kitsap County accept operation and maintenance responsibility for the storm water BMPs/facilities subject to the requirements of this title.

(3) Maintenance covenants shall remain in force for the life of the development, or until the responsibility for the operation and maintenance of the subject storm water BMPs/facilities is accepted by Kitsap County.

Section 44. Kitsap County Code Section 12.24.030, "County acceptance of new residential storm water facilities," last amended by Ordinance 540-2016, is amended as follows:

12.24.030 County acceptance of new residential storm water BMPs/facilities.

The county may accept for maintenance those new residential storm water BMPs/facilities constructed under an accepted site development activity permit that has been approved by public works and that meet the following conditions:

(1) Improvements in residential plats have been completed on at least eighty percent of the lots, unless waived by the director; and

(2) All ~~drainage-stormwater~~ BMPs/facilities have been inspected and accepted by the director and said ~~drainage-stormwater~~ BMPs/facilities have been in satisfactory operation for at least two years; and

(3) All ~~drainage-stormwater~~ BMPs/facilities reconstructed during the maintenance period have been accepted by the director; and

(4) The storm water BMP/facility, as designed and constructed, conforms to the provisions

of this title; and

(5) All easements and tracts required under this title, entitling the county to properly operate and maintain the subject ~~drainage~~ BMP/facility, have been conveyed to Kitsap County and have been recorded with the Kitsap County auditor; and

(6) For nonstandard ~~drainage~~ BMPs/facilities, an operation and maintenance manual, including a maintenance schedule, has been submitted to and accepted by Kitsap County; and

(7) A complete and accurate set of reproducible as-built drawings has been provided to Kitsap County. A professional engineer shall certify that both the vertical and horizontal alignment meet the design objectives.

Section 45. Kitsap County Code Section 12.24.040, "County acceptance of existing storm water facilities," last amended by Ordinance 540-2016, is amended as follows:

12.24.040 County acceptance of existing storm water BMPs/facilities.

Kitsap County may accept for maintenance those storm water BMPs/facilities for residential developments existing prior to the effective date of the ordinance codified in this chapter that meet the following conditions:

(1) Improvements in residential plats/PBDs have been completed on at least eighty percent of the lots; and

(2) An inspection by the director has determined that the storm water BMPs/facilities are functioning as designed; and

(3) The storm water BMPs/facilities have had at least two years of satisfactory operation and maintenance, unless otherwise waived by the director; and

(4) The person or persons holding title to the properties served by the storm water BMPs/facilities submit a petition containing the signatures of the title holders of more than fifty percent of the lots served by the storm water facilities requesting that the county maintain the storm water facilities; and

(5) All easements required under this title, entitling the county to properly operate and maintain the subject storm water BMPs/facilities, have been conveyed to Kitsap County and have been recorded with the Kitsap County auditor; and

(6) The person or persons holding title to the properties served by the storm water BMPs/facilities show proof of the correction of any defects in the drainage facilities, as required by the director.

Section 46. Kitsap County Code Section 12.24.050, "County inspections of privately maintained storm water facilities," last amended by Ordinance 540-2016, is amended as follows:

12.24.050 County inspections of privately maintained storm water BMPs/facilities.

(1) The director is authorized to develop a county inspection program for privately owned and maintained storm water facilities in Kitsap County. The purpose of this inspection program shall be for the county to determine if the ~~flow control~~ storm water BMPs/facilities, conveyance structures and ~~water quality~~ runoff treatment BMPs/facilities are in good working

order and are properly maintained, and to ensure that storm water ~~quality~~-BMPs are in place and that nonpoint source pollution control is being implemented.

(2) Whenever the provisions of the inspection program are being implemented, or whenever there is cause to believe that a violation of this title has been or is being committed, the inspector is authorized to inspect during regular working hours and at other reasonable times any and all storm water ~~drainage~~-BMPs/facilities within Kitsap County to determine compliance with the provisions of this title.

(3) Prior to making any inspections, the director or assignee shall follow the procedures delineated in Section 12.32.030.

Section 47. Kitsap County Code Section 12.24.060, "Inspection schedule," last amended by Ordinance 540-2016, is amended as follows:

12.24.060 Inspection schedule.

The director is authorized to establish a master inspection and maintenance schedule to inspect appropriate storm water facilities that are not owned and operated by Kitsap County. The party (or parties) responsible for maintenance and operation shall be identified. Critical storm water BMPs/facilities, as so deemed by the director, may require a more frequent inspection schedule.

Section 48. Kitsap County Code Section 12.30.030, "Illicit connections and uses," last amended by Ordinance 540-2016, is amended as follows:

12.30.030 Illicit connections and uses.

The storm water system of Kitsap County, natural and artificial, may only be used to convey storm water runoff. Violation of this chapter can result in enforcement action being taken as prescribed in Chapter 12.32.

No person shall use this system, directly or indirectly, to dispose of any solid or liquid matter other than storm water. No person shall make or allow any connection to the storm water system which could result in the discharge of polluting matter. Connections to the storm water system from the interiors of structures are prohibited. Connections to the storm water system for any purpose other than to convey storm water or ~~ground water~~groundwater are prohibited and shall be eliminated.

Section 49. Kitsap County Code Section 12.30.040, "Pollution control device maintenance," last amended by Ordinance 540-2016, is amended as follows:

12.30.040 Runoff treatment BMP/facility~~Pollution control device~~ maintenance.

Owners and operators of oil/water separators, wet ponds, bioretention facilities, permeable pavement systems, sand filters, vaults, sediment and erosion control systems, infiltration

systems, and any other ~~runoff treatment BMPs/facilities~~~~pollution control devices~~ shall operate and maintain such ~~control devices~~BMPs/facilities to assure that performance meets the intended level of pollutant removal. Recommended maintenance schedules for these BMPs/facilities~~devices~~ are included in the Kitsap manual.

Section 50. Kitsap County Code Section 12.36.040, "Program authority and administration," last amended by Ordinance 540-2016, is amended as follows:

12.36.040 Program authority and administration.

The storm water management program (program) is a program within the Kitsap County department of public works that implements the county's comprehensive county-wide storm water management policies and practices. The program shall be administered by the storm water division of Kitsap County department of public works, and the director thereof shall have the authority, subject to approval by the county commissioners, to implement this chapter and exercise all lawful powers necessary and appropriate for the construction, acquisition and condemnation of property rights, maintenance, management, operations and regulation of storm ~~water best management practices/facilities~~~~drainage and surface water runoff systems~~ including, without limitation, all lawful powers to fix, alter, regulate and control the rates and charges for the use thereof.

No provision of this chapter shall prevent municipalities, county agencies, departments or special districts from adopting, administering or enforcing other ordinances and regulations to protect storm water quality.

Section 51. Kitsap County Code Section 12.36.050, "Program elements," last amended by Ordinance 540-2016, is amended as follows:

12.36.050 Program elements.

The program includes the following elements: basin and watershed planning, education, capital improvements, operations and maintenance, monitoring, source control and shellfish protection (the "program").

(1) Basin and Watershed Planning. The program develops, coordinates and implements basin and watershed action plans to control surface and storm water runoff in the county.

(2) Education. The program develops and implements activities to educate the public about land use and human activities that impact water quality and storm water management. The program also develops citizen involvement opportunities to monitor streams and implement restoration programs consistent with approved basin and watershed action plans.

(3) Capital Improvements. The program develops six-year capital improvement plans that define the activities related to the acquisition, construction, replacement or renovation of capital facilities or equipment needed to address the storm water management program objectives of the county. Each capital improvement plan shall be submitted to the county commissioners for review and approval along with a plan and budget for implementation.

(4) Operations and Maintenance. The program develops and implements operations and

maintenance activities, including inspection and enforcement, to assure that all public and private drainage and storm water control facilities in the county are functional and effective. The program also performs the operations and maintenance of all county-owned storm water control facilities, and coordinates the transfer of county maintenance responsibility for private residential storm water control facilities to the county.

(5) **Monitoring.** The program develops and implements activities to monitor the ambient water quality of rivers, streams, lakes and wetlands, and evaluates the effectiveness of source controls and BMPs implemented under the basin and watershed action plans. Water quality monitoring activities are coordinated between agencies within the county, and the results of monitoring activities shall be communicated to residents, agencies and other interested persons.

(6) **Source Control.** The program develops and implements source control activities for existing development to improve water quality and focuses on reducing herbicide and pesticide usage, strengthening the on-site sewage system correction and wellhead protection programs, and strengthening the use of BMPs. The program may also provide financial assistance through low-interest loans, grants and cost sharing for the restoration of streams, repair of on-site sewage disposal systems, on-site low impact development BMPs and agricultural practice improvements.

(7) **Shellfish Protection.** The program develops and implements shellfish protection activities to accomplish the purposes outlined in Chapter 90.72 RCW. The program also coordinates the implementation of activities that provide increased shellfish protection with other counties, municipalities or special purpose districts that may establish shellfish protection programs or districts. This section, however, shall not be construed to establish a shellfish protection district.

Section 52. Kitsap County Code Section 12.40.020, "Purpose," last amended by Ordinance 549-2017, is amended as follows:

12.40.020 Purpose.

The purpose of this chapter is to establish the regulatory fees necessary to carry out the stormwater management program contemplated within RCW 36.89.020 and Chapter 12.36 by fixing rates and charges pursuant to RCW 36.89.080. These fees support the furnishing of surface and stormwater-related services to those properties that are or may be served by a stormwater drainage system, those that receive or may receive benefits from any stormwater drainage system, and those properties contributing to stormwater surface water-runoff within Kitsap County. This authority is being invoked in order to minimize property damage; promote and protect the public health, safety and welfare; minimize water quality degradation, pollution, and damage to water resources; protect drinking water aquifers; ensure the safety of county roads and rights-of-way; increase educational and recreational opportunities; encourage the retention of open space; and foster other generally beneficial public uses.

Section 53. Kitsap County Code Section 12.40.040, "Rate structure," last amended by Ordinance 549-2017, is amended as follows:

12.40.040 Rate structure.

All property shall have a base service charge of one equivalent service unit (ESU), which is four thousand two hundred square feet of impervious surface area as defined in Chapter 12.08 KCC, except when modified by measured impervious surface area as provided herein. This base charge contemplates not only the direct impacts of parcel impervious surface on runoff to the county stormwater drainage system, but also the indirect impacts of the land use on the county roads and other public infrastructure that are impacted by stormwater and which the county manages for the protection of life and property.

(1) Single-family residential property shall have the service charge of one ESU multiplied by the unit rate. Such service charge will not be affected by the existence of other uses of the property so long as the single-family residential use is the primary use.

(2) State roads shall have a service charge of thirty percent of the base service charge in accordance with RCW 90.03.525.

(3) County roads shall have a service charge of measured impervious surface area divided by square foot of one ESU (four thousand two hundred), rounded to the nearest ESU but not less than one, multiplied by the unit rate.

(4) Undeveloped land shall have no service charge.

(5) All other property shall have the service charge of measured impervious surface area divided by the square footage of one ESU (four thousand two hundred), rounded to the nearest ESU but not less than one, multiplied by the unit rate. These service charges may be reduced as follows:

(A) Rainwater Harvesting Rate Reduction. Any developed parcel that is retrofitted for rainwater harvesting may receive a fifty percent rate reduction for those surfaces from which the rain is harvested. To be eligible for this fifty percent rate reduction, the proponent must demonstrate through an analysis prepared by a licensed professional engineer that the system will result in zero surface water discharge for all storm events using the hydrologic methods described in the current Kitsap County or Washington Department of Ecology Stormwater Design Manual. The proponent is responsible for requesting the credit. The rate reduction will become effective for the calendar year following the request. Annual inspections by the department of public works to ensure proper operation and maintenance will be required to retain this rate reduction.

(B) Full Infiltration Rate Reduction. Any developed parcel that adds approved techniques (such as dispersion, bioretention, or infiltration) to attain one hundred percent infiltration of all site rain runoff water may receive a fifty percent rate reduction. To be eligible for this fifty percent rate reduction, the proponent must demonstrate through an analysis prepared by a licensed professional engineer that the system will result in zero surface water discharge for all storm events using the hydrologic methods described in the current Kitsap County or Washington Department of Ecology Stormwater Design Manual. The proponent is responsible for requesting the credit. The rate reduction will become effective for the calendar year following the request. Annual inspections by the department of public works to ensure proper operation and maintenance will be required to retain this rate reduction.

(C) Direct Discharge to Tidally Influenced Waters Rate Reduction. Any developed parcel that

is modified to discharge directly into Puget Sound, or directly into the tidally influenced areas of rivers and streams discharging into Puget Sound, and that utilizes approved techniques to meet current water quality treatment standards, may receive a fifty percent rate reduction. In order to obtain the fifty percent rate reduction, the proponent must demonstrate through an analysis prepared by a licensed professional engineer that the system conforms to the requirements of the current Kitsap County or Washington Department of Ecology Stormwater Design Manual (SDM), using the hydrologic methods described in the SDM, and that the site does not discharge surface runoff except through the direct discharge system. The proponent is responsible for requesting the credit. The rate reduction will become effective for the calendar year following the request. Annual inspections by the department of public works to ensure proper operation and maintenance will be required to retain this rate reduction.

Section 53. **Terminology corrections—'storm water' and 'ground water'.** The terms 'storm water' and 'ground water' used throughout KCC Title 12 shall be corrected to show 'stormwater' and 'groundwater' respectively.

Section 54. **Typographical/Clerical Errors.** Should any amendment made to this Ordinance that was passed by the Board during its deliberations be inadvertently left out of the final printed version of the plan, maps, or code, the explicit action of the Board as discussed and passed shall prevail upon subsequent review and verification by the Board, and shall be corrected.

Section 55. **Effective Date.** This Ordinance shall take effect on October 4, 2021.

Section 56. In order to improve consistency between Kitsap jurisdictions, as well as reduce confusion on what is state mandated versus local discretion by identifying Washington State Department of Ecology requirements versus local policies, such as Water as a Resource (Resolution #134-2016), the Kitsap County Board of Commissioners recommend that prior to formal draft preparation of future stormwater updates both the Departments of Public Works and Community Development evaluate reformatting Kitsap's stormwater design manual. This discussion should include adopting the most recent Ecology's stormwater management manual for Western Washington and providing Kitsap specific policies and requirements as an addendum.

Section 57. **Severability.** If any provision of this Ordinance or its application to any person, entity or circumstance is for any reason held invalid, the remainder of the Ordinance, or the application of the provision to other persons, entities or circumstances is not affected.

Dated this ____ day of _____, 2021

BOARD OF COUNTY COMMISSIONERS
KITSAP COUNTY, WASHINGTON

ATTEST:

ROBERT GELDER, Chair

EDWARD E. WOLFE, Commissioner

Dana Daniels, Clerk of the Board

CHARLOTTE GARRIDO, Commissioner

Approved as to form:

Kitsap County Prosecutor's Office

Dated this 28th day of June, 2021

BOARD OF COUNTY COMMISSIONERS
KITSAP COUNTY, WASHINGTON

ATTEST:



Dana Daniels

Dana Daniels, Clerk of the Board

Robert Gelder

ROBERT GELDER, Chair

E.E. Wolfe

EDWARD E. WOLFE, Commissioner

Charlotte Garrido

CHARLOTTE GARRIDO, Commissioner

Approved as to form:

Scott Nickel

Kitsap County Prosecutor's Office

Acknowledgements



2021 Stormwater Design Manual Update Authors

<u>Angie Silva</u>	<u>Kitsap County Department of Community Development (DCD)</u>
<u>Scott Diener</u>	<u>Kitsap County DCD</u>
<u>Shawn Alire</u>	<u>Kitsap County DCD/Department of Public Works</u>
<u>Jenifer Lawrence</u>	<u>Kitsap County DCD</u>
<u>David Tucker</u>	<u>Kitsap County Department of Public Works</u>
<u>Christopher May</u>	<u>Kitsap County Department of Public Works (retired)</u>
<u>Michelle Perdue</u>	<u>Kitsap County Department of Public Works</u>
<u>Michele Filley</u>	<u>Kitsap County Department of Public Works</u>
<u>Angela Gallardo</u>	<u>Kitsap County Department of Public Works/City of Tacoma</u>
<u>Rebecca Dugopolski</u>	<u>Herrera Environmental Consultants</u>
<u>Katie Wingrove</u>	<u>Herrera Environmental Consultants</u>
<u>Robin Kirschbaum</u>	<u>Robin Kirschbaum, Inc.</u>
<u>Elyssa Dixon</u>	<u>Robin Kirschbaum, Inc.</u>
<u>Adelaida Arjona</u>	<u>Robin Kirschbaum, Inc.</u>

Thanks to the Following for Their Examples and Contributions

Washington State Department of Ecology

King County

City of Seattle

City of Bellevue

Kitsap County Stormwater Design Manual

Volume I – Project Minimum Requirements and Site Planning

3rd Draft
April 2021

2021 3rd Draft Revisions are highlighted in aqua and green

This page intentionally left blank.

CONTENTS

CHAPTER 1	INTRODUCTION	1-1
1.1	Purpose of This Manual	1-1
1.2	How to Use this Manual	1-2
1.3	Purpose of Volume I	1-3
1.4	Organization of this Volume	1-3
CHAPTER 2	SITE ASSESSMENT AND PLANNING	2-1
2.1	Inventory and Analysis of Key Project Components	2-1
2.1.1	Project Boundaries and Structures	2-2
2.1.2	Soils	2-2
2.1.3	Critical Areas	2-2
2.1.4	Dewatering	2-3
2.1.5	Topography	2-3
2.1.6	Hydrologic Patterns and Features	2-3
2.1.7	Vegetation	2-5
2.1.8	Land Use Controls	2-5
2.1.9	Access	2-5
2.1.10	Utility Availability and Conflicts	2-6
2.2	Site Design Considerations	2-6
2.3	Low Impact Development	2-8
2.4	Site Mapping	2-8
2.5	Submittal Requirements	2-10
CHAPTER 3	DETERMINING MINIMUM REQUIREMENTS	3-1
3.1	Step 1 – Define the Boundaries of the Project Site	3-1
3.2	Step 2 – Identify the Receiving Water and Downstream Conveyance	3-1
3.3	Step 3 – Review Minimum Requirements Exemptions	3-3
3.4	Step 4 – Perform Site Assessment and Planning	3-3
3.5	Step 5 – Calculate New Plus Replaced Hard Surface and Native Vegetation Conversion	3-3
3.6	Step 6 – Calculate New Plus Replaced Pollution Generating Surface	3-7
3.7	Step 7 – Determine Which Minimum Requirements Apply	3-7
3.8	Step 8 – Delineate Threshold Discharge Areas (if applicable)	3-7
CHAPTER 4	MINIMUM REQUIREMENTS FOR NEW AND REDEVELOPMENT	4-1
4.1	Project Applicability	4-2

4.1.1	New Development	4-6
4.1.2	Redevelopment	4-7
4.1.3	Regional Facilities	4-8
4.2	Minimum Requirements	4-8
4.2.1	Minimum Requirement #1: Preparation of Stormwater Site Plans	4-8
4.2.2	Minimum Requirement #2: Construction Stormwater Pollution Prevention Plan (SWPPP)	4-9
4.2.3	Minimum Requirement #3: Source Control of Pollution	4-17
4.2.4	Minimum Requirement #4: Preservation of Natural Drainage Systems and Outfalls	4-18
4.2.5	Minimum Requirement #5: Onsite Stormwater Management	4-18
4.2.6	Minimum Requirement #6: Runoff Treatment	4-27
4.2.7	Minimum Requirement #7: Flow Control	4-30
4.2.8	Minimum Requirement #8: Wetlands Protection	4-33
4.2.9	Minimum Requirement #9: Operation and Maintenance	4-34

List of Figures

Figure 2.1 – Example Map Documenting Existing Hydrologic Features.	2-4
Figure 2.2 – Example Composite Site Map.....	2-9
Figure 3.1 – Example Determination of New and Replaced Hard Surfaces.	3-6
Figure 4.1 – Flow Chart for Determining Minimum Requirements for New Development Projects.....	4-4
Figure 4.2 – Flow Chart for Determining Minimum Requirements for Redevelopment Projects.....	4-5
Figure 4.3 – Flow Chart for Determining MR #5 Requirements.	4-23

List of Tables

Table 4.1 – Minimum Requirements (MR) Summary.....	4-1
Table 4.2 – Onsite Stormwater Management Requirements (MR #5) for Large Projects ^{a,b}	4-19
Table 4.3 – The List Approach for Minimum Requirement #5 Compliance.	4-21

CHAPTER 1 INTRODUCTION

1.1 Purpose of This Manual

The Kitsap County Stormwater Code meets certain requirements that apply to the County from the ~~2013–2018~~[2019-2024](#) Phase II Western Washington National Pollutant Discharge Elimination System and State Waste Discharge General Permit for Discharges from Municipal Separate Storm Sewer Systems (referred to as the Phase II NPDES Municipal Stormwater Permit). Coverage under the general permit is issued by the Washington State Department of Ecology (Ecology) pursuant to the federal Clean Water Act and state law. One of the conditions of this permit requires the County to adopt and make effective a local program to prevent and control the impacts of stormwater runoff from new development, redevelopment and construction activities. This is accomplished largely through the Kitsap County (KC) Stormwater Code (Stormwater Code) and the associated Kitsap County Stormwater Design Manual (this manual).

The Stormwater Code is contained in [Title 12](#) of the Kitsap County Code (KCC). The Stormwater Code contains regulatory requirements that provide for and promote the health, safety, and welfare of the general public. The provisions of the Stormwater Code are designed to accomplish the following:

1. Protect, to the greatest extent practicable, life, property and the environment from loss, injury, and damage by pollution, erosion, flooding, landslides, and other potential hazards, whether from natural causes or from human activity.
2. Support the water resource sustainability goals established in the [Kitsap County 2009 “Water is as a Resource NOT a Waste Stream Policy”](#) (~~KC~~ Resolution 109--2009) [and reaffirmed in 2016 \(Resolution 134-2016\)](#).
3. Protect the public interest in drainage and related functions of drainage basins, watercourses, and shoreline areas.
4. Protect receiving waters from pollution contributed by stormwater runoff.
5. Protect receiving waters from excessive flows or other forces that increase the rate of down-cutting, stream bank erosion, and/or the degree of turbidity and siltation, which will endanger aquatic and benthic life within these receiving waters.
6. Meet the requirements of state and federal law and the [Phase II NPDES Municipal Stormwater Permit](#).
7. Protect the functions and values of environmentally critical areas as required under the State’s [Growth Management Act](#) and [Shoreline Management Act](#).
8. Protect the public drainage system from loss, injury, and damage by pollution, erosion, flooding, landslides, strong ground motion, soil liquefaction, accelerated soil creep, settlement and subsidence, and other potential hazards, whether from natural causes or from human activity.

9. Fulfill the responsibilities of the County as trustee of the environment for future generations.

1.2 How to Use this Manual

This manual provides the standards to be used for stormwater management planning and design for new and redevelopment projects, in accordance with [Chapter 12.04 KCC](#). The manual is organized into two volumes, as follows:

1. *Volume I: Project Minimum Requirements and Site Planning* – Provides standards and information on how to apply the minimum requirements contained in the Stormwater Code. It also describes the site assessment and planning steps and requirements for drainage review submittals.
2. *Volume II: Technical Requirements* – Provides design standards and requirements to clearly identify for applicants the format and technical support data necessary for the development of consistent and complete design plans. Volume II contains the following chapters:
 - o Chapter 1 – Plans and Reports
 - o Chapter 2 – Construction Stormwater Pollution Prevention
 - o Chapter 3 – Source Control of Pollution
 - o Chapter 4 – Conveyance System Analysis and Design
 - o Chapter 5 – Stormwater Management BMPs
 - o Chapter 6 – Wetlands Protection
 - o Chapter 7 – Operation and Maintenance
 - o Chapter 8 – Critical Drainage Areas
 - o Chapter 9 – Grading

This manual, including both volumes, is intended to be used in conjunction with several other relevant design manuals, including:

- ~~Stormwater Management Manual for Western Washington ([Ecology Manual](#)) by the Washington State Department of Ecology Water Quality Program, [July 2019](#) amended [December 2014](#);~~
- ~~Low Impact Development Technical Guidance Manual for Puget Sound (2012 LID Technical Guidance Manual) by [Hinman and Wulkan](#) Puget Sound Partnership and [WSU Extension Center, Puyallup, Washington](#), December 2012;~~
- ~~Western Washington Low Impact Development (LID) Operations and Maintenance (O&M), by the Washington State Department of Ecology Water Quality Program, May 2013;~~

- *Highway Runoff Manual* by the Washington State Department of Transportation, ~~April~~ [April 2019](#)~~2014~~; and
- ~~Hydraulics Manual~~ by the Washington State Department of Transportation, ~~April~~ [2019](#)~~January 2015~~.
- [Rain Garden Handbook for Western Washington: A Guide for Design, Installation, and Maintenance \(Rain Garden Handbook\) by Hinman et al., June 2013](#)

The guidance provided in this manual supersedes the above referenced manuals in the event of conflicting guidelines or standards. The referenced manuals are prioritized in the order they are listed above, with the highest priority given to the Ecology Manual and the lowest priority given to the Rain Garden Handbook for Western Washington Homeowners. This manual will direct the user to the appropriate sections in these or other relevant manuals where applicable.

1.3 Purpose of Volume I

Volume I – Project Minimum Requirements and Site Planning describes and contains minimum requirements for managing stormwater runoff from new land development and redevelopment projects. It also provides site assessment and planning steps required as part of project development and describes the documentation that must be submitted and reviewed as part of the permitting process.

1.4 Organization of this Volume

Volume I contains the following chapters and appendices:

- ***Error! Reference source not found.***: *Introduction* – Outlines the purpose and content of the Stormwater Design Manual and this volume.
- ***Error! Reference source not found.***: *Site Assessment and Planning* – Summarizes site assessment and planning steps and key project components.
- ***Error! Reference source not found.***: *Determining Minimum Requirements* – Outlines steps to determine a project’s minimum requirements.
- ***Error! Reference source not found.***: *Minimum Requirements for New Development and Redevelopment* – Describes the minimum requirements for new and redevelopment projects.

~~1.5 References~~

~~AHBL and HDR. Eastern Washington Low Impact Development Guidance Manual. Prepared for Washington State Department of Ecology. June 2013.~~

~~EPA. Section 519 of the United States Federal Water Pollution Control Act (commonly referred to as Clean Water Act of 1977). 33 United States Code §1251 et seq.~~

~~Kitsap County. Resolution 109-2009 “Water as a Resource” Policy. Accessed at http://www.kitsapgov.com/sswm/pdf/Water_resource_policy.pdf on September 28, 2015.~~

~~Puget Sound Partnership and WSU Extension. Low Impact Development Technical Guidance Manual for Puget Sound, December 2012.~~

~~Washington State Department of Ecology (Ecology). Stormwater Management Manual for Western Washington, Volumes I—V, Final, Amended December 2014.~~

~~Washington State Department of Ecology (Ecology). Western Washington Low Impact Development (LID) Operations and Maintenance Manual (O&M), May 2013.~~

~~Washington State Department of Ecology (Ecology). Western Washington Phase II Municipal Stormwater Permit; National Pollutant Discharge Elimination System and State Waste Discharge General Permit for discharges from Small Municipal Separate Storm Sewers in Western Washington. Issued August 1, 2012, Effective August 1, 2013, Expires July 31, 2018, Modified January 16, 2014.~~

~~Washington State Department of Transportation (WSDOT). Highway Runoff Manual, April 2014.~~

~~Washington State Department of Transportation (WSDOT). Hydraulics, January 2015.~~

CHAPTER 2 SITE ASSESSMENT AND PLANNING

Before evaluating minimum requirements and starting the process for selecting Onsite Stormwater Management, Flow Control, and [Runoff Water Quality](#) Treatment BMPs, each project must first assess and evaluate existing and post-development site conditions. Site planning helps to maximize the potential development site opportunities while minimizing project-related stormwater impacts by minimizing impervious areas, loss of vegetation, and the volume and rate of runoff generated that must be subsequently managed on site.

This section outlines requirements for inventory and analysis of key project components, site design considerations, use of Low Impact Development (LID)/Green Stormwater Solutions (GSS) as the preferred approach to planning and design, site mapping, and submittal requirements.

2.1 Inventory and Analysis of Key Project Components

Performing a comprehensive inventory and analysis is an essential first step to site assessment and planning, and must precede site design. The inventory shall include on- and offsite natural and built conditions that would affect the project design. Policies, land use controls, and legally enforceable restrictions shall also be evaluated and documented (Puget Sound Partnership and WSU Extension, 2012).

The following sections provide additional guidance on key project components that can significantly influence the project design. These key components shall be inventoried and analyzed as part of the site assessment and planning step:

- Project boundaries and structures
- Soils
- Critical areas
- Dewatering
- Topography
- Hydrologic patterns and features
- Vegetation
- Land use control
- Access
- Utility availability and conflicts

See the County's Geographic Information System (GIS) mapping website for available information that may be used as a resource for creating this inventory of key components, as appropriate.

2.1.1 Project Boundaries and Structures

Project boundaries, nearby structures, and other related issues can directly affect stormwater runoff and BMP designs. The following must be addressed before selecting a stormwater management BMP:

- Project Boundaries: The project boundaries typically define the limits of disturbance and can affect the thresholds and applicable minimum requirements. Project boundaries generally coincide with the [right of way](#) and/or property line.
- Setbacks: Property lines, adjacent [right of way](#) boundaries, and setbacks required from each must be identified and considered to evaluate siting of structures.
- Location of Buildings: All existing and proposed buildings must be identified, including all existing and proposed temporary and permanent structures (such as retaining walls) and impervious surfaces (driveways, patios, etc.). Structures on neighboring properties can also affect stormwater BMP selection, and shall be identified on plans as appropriate.
- Foundations and Footing Drains: The type of proposed foundations and footing drains, including location and extent, must be determined. These features can include:
 - Conventional spread footings
 - Pile shaft
 - Basement
 - Footing drains and their associated point of discharge, if applicable
 - Water-tight foundation without footing drains

2.1.2 Soils

The existing soil types present must be evaluated to assess the infiltration capacity of the site and the applicability of various stormwater BMPs. General requirements for infiltration facilities, including site characterization and infiltration rate determination, are presented in [Volume I, Error! Reference source not found. in this volume](#) and in Volume II, Chapter 5.

2.1.3 Critical Areas

Additional regulatory requirements are placed on projects that are within or near critical areas, pursuant to [Title 19 KCC](#). Such areas include streams, wetlands, frequently flooded areas, critical aquifer recharge areas and geologically hazardous areas. Depending upon the type of critical area, additional requirements or limitations regarding stormwater management may apply. See [Chapter 12.28 KCC](#) and Volume II, Chapter 8 ~~of this manual~~ and [the Title 19 KCC County's Critical Areas Ordinance website](#) for more information.

2.1.4 Dewatering

It is important to have early estimations of the groundwater discharge from the project site. The site's proximity to receiving waters or its location in areas where there may be perched, static, tidally influenced or hydraulically connected groundwater can have significant impacts on how the project is designed and which requirements may apply. Additional information on dewatering is described as part of the minimum requirements for Construction Stormwater Pollution Prevention ([Volume I, Error! Reference source not found. in this volume](#)).

2.1.5 Topography

Understanding the existing site topography is important to implementing LID principles, such as minimizing grading and preserving existing flow paths. Topography will also influence how and where stormwater facilities are incorporated into the site. Important features to assess and document include:

- Steep slopes
- Closed depressions
- Grade breaks
- Roadway grades and elevations

2.1.6 Hydrologic Patterns and Features

To maintain existing hydrologic patterns and important features, onsite hydrologic processes, patterns, and physical features must be understood and documented. This step requires documenting the following feature types, among others found on site that may influence drainage patterns:

- Streams
- Wetlands
- Native soils and vegetation (see also [Volume I, Section 2.1.7-of this manual](#))
- Seeps
- Springs
- Closed depressions (see also [Volume I, Section 2.1.5-of this manual](#))
- Drainage swales and ditches
- Signs of erosion
- Natural discharge location(s)

To the extent possible, this step should be undertaken during wet periods. See Figure 2.1 for an example map of hydrologic features for a hypothetical subdivision development.

[\(See separate file for Public Review Draft figures.\)](#)

Figure 2.1 – Example Map Documenting Existing Hydrologic Features.

Detailed subbasin delineation provides several advantages as follows:

- Individual practices receive smaller hydraulic and pollutant loads.
- Small-scale practices can be arranged in the project efficiently and save space for other amenities.
- Individual LID BMPs can be accurately sized based on the appropriate tributary drainage areas and their cumulative performance across the site can be evaluated.

2.1.7 Vegetation

Vegetated areas of a project site can be very effective in minimizing stormwater runoff. Existing site vegetation shall be characterized as part of the site assessment, and may be accomplished through the use of aerial imagery, observations recorded during site walks, or other approved methods to delineate forest, pasture, grassed and landscaped areas in the existing conditions. Efforts shall be made to configure the project to minimize disturbance of areas covered by valuable existing vegetation, such as mature trees.

2.1.8 Land Use Controls

Applicable land use controls, such as limitations on impervious surface coverage, minimum landscaping requirements, minimum lot area, setback requirements, parking requirements, and site design standards associated with building placement and orientation, shall be analyzed and documented using the following steps:

- Review applicable comprehensive plan designation, zoning classifications, and overlay districts that may apply to the site. Overlay districts may include requirements for special design review or district overlays.
- Determine whether the Shoreline Master Program applies to the site and comply with applicable guidelines and requirements.
- Consult with the Kitsap County Development Services and Engineering (DSE) Division of Department of Community Development (DCD) to identify other land use regulations that may allow clustering or other practices intended to minimize impervious surfaces. Examples include Performance-based Developments and Master Plan developments.

2.1.9 Access

Vehicular and pedestrian access, circulation, and parking elements of the built environment shall be identified as part of the site inventory and analysis. Access can often represent a controlling element for the design of a site.

The designer shall consult the Kitsap County Road Standards and applicable zoning in [Title 17](#) KCC for site access. These requirements will establish the number of allowed access points, the width of the access, the spacing of access points between sites on the same or opposite side of

the adjacent street ~~right of way~~^{right-of-way}, and pedestrian circulation requirements along and through the site to the proposed use.

The following steps shall, at minimum, be used to inventory and assess access:

- Map the location of roads, driveways, and other points of ingress and egress within 100 feet of the site.
- Refer to the Kitsap County Road Standards to identify the classification of the street that will be providing access to the site. Knowing the classification of the abutting street will allow the designer to understand frontage improvements, sight distance requirements, allowed driveway widths, and other geometric design requirements.
- Consult with the Kitsap County Public Works (KCPW) Transportation Planning Division to understand any motorized or non-motorized plans that may influence the design of the project.

2.1.10 Utility Availability and Conflicts

The location of wet (e.g., water, sewer, stormwater, etc.) and dry (e.g., power, phone, cable, etc.) utilities shall be identified and the adequacy of these utilities shall be confirmed. If new utilities need to be extended to the site, the applicant will need to understand where the utility will come from, and potentially extend to, and the impact that easements and restrictions may have on the site design.

The following steps shall be used to assess utilities:

- Consult with the utility purveyor(s) to determine the location of wet (e.g., water, sewer, stormwater, etc.) and dry (power, phone, cable, etc.) utilities and discuss the proposed plans. This consultation shall be initiated during the planning phase of the project and extended through final design. Utilities Locate Service number is 811.
- Map existing utilities and utility easements on the site plan. Note the setbacks from the easements that may be required.
- Map existing utilities that may need to be moved and new utilities to be extended to the site.
- Design appropriate measures to move or protect utilities, as needed.

2.2 Site Design Considerations

To manage stormwater effectively and efficiently, site design for both construction and the post-development condition must be done in unison with the design and layout of the stormwater infrastructure. Efforts should be made, as required and encouraged by Kitsap County development codes, such as Titles [12](#), [16](#), and [17](#), to conserve natural areas, retain native vegetation, reduce impervious surfaces, and integrate stormwater controls into the existing site drainage patterns to the maximum extent feasible. With careful planning, these efforts will not only help achieve the minimum requirements contained in the Stormwater Code but can also

reduce impacts from development projects and reduce the costs of [runoffwater quality](#) treatment and flow control.

Before designing the site and stormwater infrastructure, consider the following:

- Stormwater:
 - Identify the approved point(s) of discharge and conveyance system flow path(s) based on both piped conveyance and natural topography.
 - Using LID/GSS principles, manage stormwater runoff (quantity and quality) as close to the point of origin as possible.
 - Minimize the use of conventional stormwater collection (catch basins) and piped conveyance infrastructure.
 - Use LID/GSS BMPs (e.g., dispersion, infiltration, and reuse) where feasible.
 - Fit development to the terrain to minimize land disturbance and loss of natural vegetation, especially mature coniferous forest.
- Landscaping:
 - Maintain and use natural drainage patterns.
 - Preserve natural features and resources, including trees.
 - Create a multifunctional landscape using hydrology as a framework for landscape design.
 - Confine and phase construction activities to minimize disturbed [areas, and areas and](#) minimize impacts to environmentally critical areas and their associated buffers.
 - Plant new trees in proximity to ground level impervious surfaces for onsite stormwater management and/or flow control credit.
 - Minimize or prevent compaction of and protect soils.
 - Amend landscape soils to promote infiltration.
- Impervious and Pervious Surfaces:
 - For sites with varied soil types, locate impervious areas over less permeable soil (e.g., till). Minimize development over more porous soils. Use porous soils by locating bioretention, permeable pavement, or other approved infiltration methods over them.
 - Cluster buildings together.
 - Minimize impervious surfaces (e.g., buildings, sidewalks, etc.).
 - Minimize pollution-generation hard surface (PGHS) (e.g., areas subject to vehicular use such as driveways and parking strips).
 - Minimize pollution-generating pervious surfaces (PGPS) (e.g., fertilized lawns, flower beds, etc.). Consider landscaping with native vegetation.

2.3 Low Impact Development

Low impact development (LID) is a stormwater and land use management strategy that strives to minimize pre-disturbance to hydrologic processes of infiltration, filtration, storage, evaporation, and transpiration. In Kitsap County and elsewhere, the terms Green Stormwater Solutions (GSS) or Infrastructure (GSI) are also used to describe LID stormwater management practices. LID/GSS goals are accomplished by emphasizing conservation and use of onsite natural features, site planning, and distributed stormwater management practices that are integrated into a project design. LID/GSS strategies can be applied to new development, urban retrofits, infrastructure improvements, and revitalization projects to protect aquatic resources.

LID/GSS principles and applications present a significant conceptual shift from a purely structural to a primarily source reduction approach. Site planning and stormwater management are integrated at the initial design phases of a project to maintain a more hydrologically functional landscape even in denser settings. Hydrology and natural site features that influence water movement (described above) are used to guide road, structure, and other infrastructure layout. Native soil and vegetation protection areas and landscaping are strategically distributed throughout the project to slow, store, and infiltrate storm flows, and also serve as project amenities.

The goal of LID/GSS is to prevent physical, chemical or biological degradation to streams, lakes, wetlands, and other natural aquatic systems from commercial, residential or industrial development sites. Properly designed LID/GSS measures can reduce stormwater runoff from a project site. As a result, the size and cost of conveyance, flow control, and [Water Quality Runoff Treatment BMPs](#) can be greatly reduced or, in some cases, eliminated. A good description of the LID planning, along with detailed descriptions of LID measures can be found in the *LID Technical Guidance Manual*.

2.4 Site Mapping

Through the assessment process discussed in Section 2.1 above, map layers are produced to delineate important site features. These map layers are combined to provide a composite site map that guides the layout of streets, structures, and other site features and the overall location of the development envelope(s). This composite site map ~~shall~~ be used for all development types and will form the basis for the site design considerations described in Section • and help to identify LID practices as described in Section 2.3. Figure 2.2 illustrates the process of developing a composite site map.

Figure 2.2 – Example Composite Site Map.

2.5 Submittal Requirements

A Site Assessment and Planning Packet (See Volume II, Chapter 1, [and](#) Appendix C) must be completed to document the assessment of key project components and site design considerations discussed above in this chapter. The packet consists of the following elements, each of which must be completed by the applicant and submitted as part of permit review:

- A. Project Information – Includes basic project summary information.
- B. Existing Site Composite Map – Combines the information analyzed in Section 2.1 into a single site map that is used as the basis for site design.
- C. Existing Site Inventory and Analysis Checklist – Documents findings from the inventory and analysis as described in Section 2.1.
- D. Existing and Proposed Site Land Cover Areas – Summarizes existing and proposed site land cover areas. This summary information helps demonstrate compliance with the requirement to minimize impervious area, loss of vegetation, and stormwater runoff.
- E. Proposed Site LID BMP Matrix – Documents LID BMP infeasibility evaluation and provides justification for why individual LID BMPs were included or not included in site plans.

Volume II, Chapter 1 provides more detailed discussion of the permit review process and Appendix C ~~in the same chapter~~ includes a printable copy of the Site Assessment and Planning Packet.

CHAPTER 3 DETERMINING MINIMUM REQUIREMENTS

Per [Chapter 12.08 KCC](#), “project site” means “portion of a property, properties, or [right of way](#) subject to land disturbing activities, new hard surfaces, or replaced hard surfaces.” Such activities can negatively affect stormwater runoff from the project site. This chapter contains seven basic steps used to determine which minimum requirements for onsite stormwater management, flow control, and [water quality runoff](#) treatment apply to a project site:

- *Step 1* – Define the boundaries of the project site.
- *Step 2* – Identify the receiving water and downstream conveyance.
- *Step 3* – Review minimum requirement exemptions.
- *Step 4* – Perform site assessment and planning.
- *Step 5* – Calculate new plus replaced hard surface and native vegetation conversion.
- *Step 6* – Calculate new plus replaced pollution generating surface.
- *Step 7* – Determine which minimum requirements apply.
- *Step 8 – Delineate Threshold Discharge Areas within the site (if applicable)*

Note that these steps are focused on determining applicable minimum requirements for onsite stormwater management, flow control, and [water quality runoff](#) treatment specifically. Applicants must also review and comply with all other minimum requirements listed in [Volume I](#). **Error! Reference source not found.** ~~of this manual~~, including preparation of a stormwater site plan, control of site construction stormwater, source control, preservation of natural discharge location, wetland protection and operation and maintenance. Each of the seven steps is described in further detail below.

3.1 Step 1 – Define the Boundaries of the Project Site

The boundaries of the project site must contain all land disturbing activities, and all new and replaced hard surfaces. The project site may also include contiguous areas that abut the lot or parcel that triggered the [right of way](#) or utility improvements.

3.2 Step 2 – Identify the Receiving Water and Downstream Conveyance

For minimum requirement purposes, runoff leaving the project site is classified based on the type of receiving water and/or drainage system into which the project site discharges. [The minimum requirements vary considerably based on these classifications.](#) The applicant must [thus](#) determine the receiving water or [natural discharge point of discharge](#) for the stormwater runoff from the project site (e.g., wetland, lake, creek, ~~or~~ salt water, [or Underground Injection Control \[UIC\]](#)) [and the -](#)

~~The minimum requirements vary considerably by type of receiving water and downstream conveyance; therefore, it is important to determine and specify the receiving water and type of downstream conveyance. In addition, the applicant must also note the sequence of the discharge should also be noted.~~ For example, projects discharging to a drainage system within a creek basin that then discharge to a designated receiving water must meet the requirements applicable to creek basins.

An overview of the types of receiving waters and drainage systems is provided below:

- Wetlands are designated under [Chapter 19.200 KCC](#).
- Flow Control-Exempt Receiving Waters listed in Appendix I-A of the Ecology Manual are approved by Ecology as having sufficient capacity to receive discharges of drainage water. Stormwater discharges to salt water bodies, including Puget Sound, and other large rivers and lakes listed in Appendix I-A of the Ecology Manual are exempt from the flow control requirement provided that the project meets all restrictions included in ~~the same Appendix I-A of the Ecology Manual~~.
- Non-Flow Control-Exempt Receiving Waters include creeks, lakes, or other receiving water bodies not listed in [Appendix I-A of the Ecology Manual](#).
- Critical Drainage Areas refers to those areas designated in [Chapter 12.28 KCC](#) (Critical Drainage Areas), which have a high potential for stormwater quantity or quality problems. In order to mitigate or eliminate potential drainage-related impacts on critical drainage areas, the director may require drainage improvements in excess of those required by the minimum requirements.
- Conveyance Systems are both natural and manmade systems which collect, contain, and provide for the flow of surface and stormwater from the highest points on the land down to a receiving water. The natural elements of the conveyance system include swales and small drainage courses, streams, rivers, lakes, and wetlands. The human made elements of the conveyance system include gutters, ditches, pipes, channels, and most retention/detention BMPs. are composed of manmade conveyance elements (e.g., pipes, ditches, outfall protection). While downstream conveyance systems do not affect minimum requirements applicability, the applicant must demonstrate that the proposed project would not aggravate existing problems or create new problems for those systems (See Volume II, Chapter 4.7).

Receiving waters may also have specific management plans that have established specific requirements. Such management plans could potentially affect how the minimum requirements ~~should shall~~ be applied to a given project (see [Volume I, Section 3.7 of this volume](#)). Examples of plans to be aware of include:

- Watershed or Basin Plans can be developed to cover a wide variety of geographic scales (e.g., Water Resource Inventory Areas, or subbasins of a few square miles), and can be focused solely on establishing stormwater requirements (e.g., “Stormwater Basin Plans”), or can address a number of pollution and water quantity issues, including urban stormwater (e.g., Puget Sound Non-Point Action Plans).

- [Water Clean-Up Plans](#) establish a Total Maximum Daily Load (TMDL) of a pollutant or pollutants in a specific receiving water or basin, and to identify actions necessary to remain below that maximum loading. The plans may identify discharge limitations or management actions (e.g., use of specific treatment facilities) for stormwater discharges from new and redevelopment projects.
- [Groundwater Management Plans \(Wellhead Protection Plans\)](#) protect ground water quality and/or quantity, these plans may identify actions required of stormwater discharges.
- [Lake Management Plans](#) are developed to protect lakes from eutrophication due to inputs of phosphorus from the drainage basin. Control of phosphorus from new development is a likely requirement in any such plans.

3.3 Step 3 – Review Minimum Requirements Exemptions

The practices described in [KCC 12.10.040 Exemptions](#) and [12.16.070 Permit Exemptions](#) are exempt from the minimum requirements, even if such practices meet the definition of new development or redevelopment. See discussion in [Volume I, Section 3.7-of this volume](#) regarding other permit requirements that may apply for projects that are otherwise exempt from meeting these minimum requirements.

3.4 Step 4 – Perform Site Assessment and Planning

Each project must evaluate project design considerations and perform a site assessment as outlined in [Volume I, Error! Reference source not found.-above](#). The goal of the site assessment and planning step is to identify any issues that must be addressed in association with stormwater management requirements. This step must be completed before selecting Onsite Stormwater Management, Flow Control, and/or [Water QualityRunoff](#) Treatment BMPs.

Project proponents need to evaluate all applicable code requirements and conduct a full site assessment to characterize site opportunities and constraints before choosing and designing stormwater strategies (refer to [Volume I, Error! Reference source not found.](#)). Once the site conditions are known and the applicable minimum requirements have been identified, proceed to Volume II, Chapters 3; [Volume II, Chapter 4](#); and [Volume II, Chapter through 5](#) to begin the BMP selection and design process.

3.5 Step 5 – Calculate New Plus Replaced Hard Surface and Native Vegetation Conversion

The thresholds triggering specific minimum requirements are based on the amount of the project's new and replaced hard surface and converted native vegetation. Note that open, uncovered retention or detention facilities shall not be considered as hard surfaces for the purposes of determining whether the minimum requirement thresholds are exceeded. However, these facilities shall be considered hard surfaces for the purposes of stormwater facility sizing.

Permeable pavement, vegetated roofs and areas with underdrains (e.g., playfields, athletic fields, rail yards) shall be considered as hard surfaces for the purposes of determining whether the minimum requirement thresholds are exceeded.

Refer to [Chapter 12.08 KCC](#) and Appendix A for detailed definitions of these key terms. The amount of native vegetation that is removed and replaced with lawn, landscaping, and pasture groundcover must also be calculated. New plus replaced hard surface areas and converted native vegetation shall be quantified separately for work within and outside the [right of way](#)~~right-of-way~~.

Figure 3.1 illustrates an example of how to determine new and replaced hard surfaces for a hypothetical Single Family Residential redevelopment project. In this example, the existing single-story house (30' x 50', or 1,500 square feet existing roof area) will be demolished and replaced with a two-story house (40' x 70' = 2,800 square feet of new and replaced roof area). In order to calculate the new plus replaced hard surfaces in this step, existing and removed hard surfaces also need to be tabulated, as follows:

- Existing Hard Surface (476 square feet) – Includes the existing hard surfaces to remain after construction, including the existing driveway (10' x 20' = 200 square feet), shed (8' x 12' = 96 square feet), and the portion of the existing walkway to remain (180 square feet).
- New Hard Surface (1,425 square feet) – Includes the portion of the proposed project site that was not previously covered in hard surface, but that will be covered in hard surface as a result of proposed roof area expansion, extension of the existing walkway, and new permeable pavement patio. New hard surfaces include the new building footprint (2,800 square feet) minus the existing building footprint (1,500 square feet) minus the portion of the existing back deck and walkway to be replaced (120 square feet). In addition to the new roof area, new hard surfaces include the new permeable pavement patio (10' x 12' = ~~120~~ = 120 square feet) and the new extension of the existing walkway (125 square feet), extending from the existing walkway to remain to the new permeable pavement patio. Thus, the total new hard surface area in this example is 1,425 square feet (2,800 – 1,500 – 120 + 120 + 125 [square feet]).
- Replaced Hard Surface (1,620 square feet) – Includes the part of the proposed new house footprint that overlaps the existing house footprint. This includes the 1,500 square feet of existing building footprint plus the 120 square feet of patio and walkway area behind the existing house, for a total of 1,620 square feet of replaced hard surface.
- Removed Hard Surface (30 square feet) – Includes the portion of the existing walkway that will be removed when the walkway is extended. This piece of removed walkway is not replaced with any other hard surface.

The total new plus replaced hard surface in this example is calculated as 3,045 square feet (1,425 + 1,620). Note, there is zero (0) native vegetation conversion in this example.

As illustrated in this example and as may be typical for many development sites, the existing, new, replaced, and removed hard surface areas are irregular in shape, and they may overlap each other in irregular patterns. For example, see the irregular polygon shapes for the existing back patio and walkway behind the existing house, to be replaced by new roof, and the small portion of the existing walkway that will be removed when the extended walkway is connected to the existing walkway to remain. Due to these irregular shapes, ~~the areas should be~~ these areas calculated using area take-off methods from scaled drawings or in AutoCAD to accurately delineate and calculate the respective areas for these various features.

Figure 3.1 – Example Determination of New and Replaced Hard Surfaces.

3.6 Step 6 – Calculate New Plus Replaced Pollution Generating Surface

The thresholds triggering specific minimum requirements for runoff treatment are based on the total amount of the project's new plus replaced PGHS and PGPS, as these areas are considered a significant source of pollutants in stormwater runoff. PGHS examples include areas subject to vehicular use (including permeable pavement); certain industrial activities; and outdoor storage of erodible or leachable materials, wastes, or chemicals. Metal roofs are also considered to be PGHS unless they are coated with an inert, non-leachable material (e.g., baked-on enamel coating). Examples of PGPS include lawns and landscaping areas subject to the use of fertilizers and pesticides. Refer to Appendix A for detailed definitions of these key terms.

New plus replaced PGHS and PGPS shall be quantified separately for work within and outside the ~~right of way~~ right-of-way.

3.7 Step 7 – Determine Which Minimum Requirements Apply

Steps 1 through 6 produce the information necessary for determining the minimum applicable stormwater requirements. These minimum requirements are found in Volume I, Error! Reference source not found. ~~of this volume. See The charts found in~~ Figure 4.1 and Figure 4.2 ~~should be consulted~~.

In addition to the minimum requirements presented in Volume I, Error! Reference source not found., additional requirements apply to site development activities that require land use permits and approvals as defined in KCC Section 12.04.030 and Chapter 12.08 KCC. Review all permit requirements in the code, including but not limited to, Site Development Activity Permits (SDAP) (KCC Section 12.10.030), requirements for a professional engineer (KCC Section 12.10.060), downstream analysis (KCC Section 12.10.070), geotechnical analysis (KCC Section 12.10.080), ~~and~~ soils analysis (KCC Section 12.10.090) ~~and critical drainage areas (Chapter 12.28 KCC and Title 19 KCC)~~. See Volume II, Chapter 1 for plan and submittal requirements relating to the minimum requirements and any additional permit requirements that apply.

3.8 Step 8 – Delineate Threshold Discharge Areas (if applicable)

Threshold Discharge Areas (TDAs) may be applicable for rural (outside the UA and UGA) residential sites that are 5 acres or greater.

If a TDA approach is being implemented, delineate the TDAs within the site. See the definition of TDA in Appendix A for guidance on how to delineate a TDA. For each minimum requirement that is applicable to the project (per Step 7), use the TDA thresholds to determine which, if any, BMP(s) must be constructed within each TDA to satisfy that minimum requirement. The TDA thresholds are provided within the text of Minimum Requirements #6, #7, and #8 (Volume I

Section 4.2.6, Section 4.2.7, and Section 4.2.8). Minimum Requirements #1-5 and #9 do not have separate TDA thresholds and must be applied to the entire project if they are applicable.

Implementation of a TDA approach requires downstream analysis (KCC 12.10.070). Other technical analyses may be required depending on site conditions including, but not limited to, geotechnical analysis (KCC 12.10.080) and critical drainage area evaluation (Chapter 12.28 KCC and Title 19 KCC). The director has the authority to require additional technical analysis if warranted. See Volume II, Chapter 1 for plan and submittal requirements related to TDAs. Note that a professional engineer is required when a TDA approach is implemented (Volume II, Chapter 1).

CHAPTER 4 MINIMUM REQUIREMENTS FOR NEW AND REDEVELOPMENT

This chapter identifies the nine minimum requirements for stormwater management that pertain to new development and redevelopment sites. The minimum requirements are summarized in Table 4.1, with a brief summary description of each and reference to the applicable section in this manual for detailed requirements.

Table 4.1 – Minimum Requirements (MR) Summary.			
MR #	MR Name	Summary Description	Manual Reference
1	Preparation of Stormwater Site Plans	Projects shall prepare a Stormwater Site Plan, providing comprehensive reporting of the technical information and analysis necessary to review compliance with the Stormwater Code.	Volume I, Section 4.2.1
2	Construction Stormwater Pollution Prevention	Requires projects to prevent erosion and discharge of sediment and other pollutants into receiving waters during construction activities.	Volume I, Section 4.2.2
3	Source Control of Pollution	All known, available and reasonable source control BMPs shall be applied to all projects.	Volume I, Section 4.2.3
4	Preservation of Natural Drainage Systems and Outfalls	Natural drainage patterns shall be maintained, and discharges from the project site shall occur at the natural location, to the maximum extent practicable. The manner by which runoff is discharged from the project site shall not cause a significant adverse impact to downstream receiving waters and downgradient properties. All outfalls shall provide energy dissipation.	Volume I, Section 4.2.4
5	Onsite Stormwater Management	Projects shall employ Onsite Stormwater Management BMPs in accordance with the prescribed projects thresholds, standards, and lists to infiltrate, disperse, and retain stormwater runoff on site to the extent feasible without causing flooding or erosion impacts.	Volume I, Section 4.2.5

MR #	MR Name	Summary Description	Manual Reference
6	Runoff Treatment	Projects shall provide runoff treatment to reduce pollutant loads and concentrations in stormwater runoff using physical, biological, and chemical removal mechanisms so that beneficial uses of receiving waters are maintained and, where applicable, restored.	Volume I, Section 4.2.6
7	Flow Control	Projects shall provide flow control to reduce the impacts of stormwater runoff from hard surfaces and land cover conversions.	Volume I, Section 4.2.7
8	Wetlands Protection	Projects whose stormwater discharges into a wetland, either directly or indirectly through a conveyance system shall comply with Volume II, Chapter 6 of this manual.	Volume I, Section 4.2.8
9	Operation and Maintenance	An operation and maintenance manual that is consistent with the provisions in Volume II, Chapter 7 of this manual shall be provided for proposed stormwater facilities and BMPs, and the party (or parties) responsible for maintenance and operation shall be identified.	Volume I, Section 4.2.9

Additional requirements beyond these nine minimum requirements apply to site development activities that require land use permits and approvals as defined in KCC [Section 12.04.030](#) and Chapter [12.08 KCC](#). Review all permit requirements [in the code](#), including but not limited to SDAPs (KCC [Section 12.10.030](#)), requirements for a professional engineer (KCC [Section 12.10.060](#)), downstream analysis (KCC [Section 12.10.070](#)), geotechnical analysis (KCC [Section 12.10.080](#)), ~~and~~ soils analysis (KCC [Section 12.10.090](#)), ~~and critical drainage areas (Chapter 12.28 KCC and Title 19 KCC)~~. See Volume II, Chapter 1 ~~of this manual~~ for plan and submittal requirements relating to the minimum requirements and additional permit requirements that apply.

4.1 Project Applicability

Not all of the minimum requirements apply to every development or redevelopment project. The applicability varies depending on the project type and size. This section identifies thresholds that determine the applicability of the minimum requirements to different projects.

The minimum requirement thresholds vary for projects inside and outside of Urban Growth Areas (UGAs). Use the flow charts in Figure 4.1 and Figure 4.2 and the summary text provided

in the following sections to determine which of the minimum requirements apply. The minimum requirements themselves are defined in detail in Section 4.2.

Figure 4.1 – Flow Chart for Determining Minimum Requirements for New Development Projects.

Figure 4.2 – Flow Chart for Determining Minimum Requirements for Redevelopment Projects.

4.1.1 New Development

All new development shall be required to comply with Minimum Requirement #2 – Construction Stormwater Pollution Prevention.

The following new development shall comply with Minimum Requirements #1 through #5 for the new and replaced hard surfaces and the land disturbed:

- Results in 2,000 square feet or more of new plus replaced hard surface area; or
- Includes land disturbing activity of 7,000 square feet or more.

For sites located inside census defined urban areas or UGAs, the following new development shall comply with Minimum Requirements #1 through #9 for the new and replaced hard surfaces and the converted vegetation areas:

- Results in 5,000 square feet or more of new plus replaced hard surface area; or
- Converts 3/4 acre or more of vegetation to lawn or landscaped areas; or
- Converts 2.5 acres or more of native vegetation to pasture.

For sites located outside census defined urban areas or UGAs, the following new development shall comply with Minimum Requirements #1 through #9 for the new and replaced hard surfaces and converted vegetation areas:

- Results in 10,000 square feet or more of new plus replaced hard surface area, or results in 5% or more of hard surface area covering the lot area (whichever is greater); or
- Includes grading involving the movement of 5,000 cubic yards or more of material.

For purposes of applying the above thresholds to a proposed single family residential subdivision (i.e., a plat or short plat project), assume 4,200 sq. ft. of hard surface (8,000 sq. ft. on lots of 5 acres or more) for each newly created lot, unless the applicant has otherwise formally declared other values for each lot in the corresponding complete land division application. Where land use regulations restrict maximum hard (or impervious) surfaces to smaller amounts, those maxima may be used. [The minimum design assumption for hard surfaces and developed pervious surfaces shall be determined as part of the overall drainage design and included in the design submittal documentation \(see Volume II, Section 1.2.5\).](#)

Regional stormwater facilities may be used as an alternative method of meeting Minimum Requirements #6, #7, and #8, through documented engineering reports detailing how the proposed facilities meet these requirements for the sites that drain to them. Such facilities must be operational prior to and must have capacity for new development.

Where new development projects require improvements (e.g., frontage improvements) **that are not within the same TDA threshold discharge area**, the director may allow the minimum requirements to be met for an equivalent (flow and pollution characteristics) area that drains to the same receiving water.

4.1.2 Redevelopment

All redevelopment shall be required to comply with Minimum Requirement #2. The following redevelopment shall comply with Minimum Requirements #1 through #5 for the new and replaced hard surfaces and the land disturbed:

- Results in 2,000 square feet or more of new plus replaced hard surface area; or
- Includes land disturbing activity of 7,000 square feet or more.

For sites located inside census defined urban areas or UGAs, the following redevelopment shall comply with Minimum Requirements #1 through #9 for the new hard surfaces and converted vegetation areas:

- Adds 5,000 square feet or more of new hard surfaces or;
- Converts 3/4 acre or more of vegetation to lawn or landscaped areas; or
- Converts 2.5 acres or more of native vegetation to pasture.

For sites located outside census defined urban areas or UGAs, the following redevelopment shall comply with Minimum Requirements #1 through #9 for the new hard surfaces and converted vegetation areas:

- Adds 10,000 square feet or more of new hard surface area, or results in 5% or more of hard surface area covering the lot area (whichever is greater); or
- Includes grading involving the movement of 5,000 cubic yards or more of material.

The director may allow the minimum requirements to be met for an equivalent (flow and pollution characteristics) area within the same site. For public roads projects, the equivalent area does not have to be within the project ~~limits, but~~ limits but must drain to the same receiving water.

If implementing a TDA approach in a rural residential area (see Section 4.2), the equivalent area may be within the same TDA. If the equivalent area is outside the TDA, or off-site, the equivalent area must drain to the same receiving water and the guidance for equivalent facilities using in-basin transfers must be followed (refer to Volume I, Section I-D 6 of the Ecology Manual).

4.1.2.3 Additional Requirements for the Project Site Redevelopment

For ~~r~~road-related projects, ~~runoff from the replaced and~~ shall comply with all the Minimum Requirements for the new and replaced hard surfaces (including pavement, shoulders, curbs, and sidewalks) and the converted vegetated vegetation areas ~~shall meet all the minimum requirements~~ if the new hard surfaces total 5,000 square feet or more and total 50% or more of the existing hard surfaces within the project limits. The project limits shall be defined by the length of the project and the width of the right of way ~~right of way~~.

Other types of redevelopment projects shall comply with all the Minimum Requirements ~~#1 through #9~~ for the new and replaced hard surfaces and the converted vegetated areas if:

- ~~The~~ total of new plus replaced hard surfaces is 5,000 square feet or more, and
- ~~For commercial or industrial projects:~~ the valuation of proposed improvements, including interior improvements, exceeds 50% of the assessed value of the existing project site improvements.
- For all other projects: the valuation of the proposed improvements, including interior improvements, exceeds 50% of the assessed value of the existing site improvements.

If runoff from new hard surfaces, converted vegetation areas, and replaced hard surfaces is not separated from runoff from other existing surfaces within the project site or the site, the guidance in [Volume III, Section 2.4 of the Ecology Manual Appendix III-B of the Ecology Manual for off-site inflow](#) shall be used to size the detention facilities.

4.1.3 Regional Facilities

~~Regional facilities may be allowed as an alternative method to meet Minimum Requirements #5, #6, #7, and/or #8. The County will require an engineering report to be submitted that details how the regional facility meets the Minimum Requirements for the sites that drain to it. See Volume I, Appendix I-D of the Ecology Manual for details. Contact the Department of Public Works Stormwater Division for more information on regional facilities within Kitsap County.~~

4.2 Minimum Requirements

This section describes the minimum requirements for stormwater management at development and redevelopment sites. ~~See Volume I, Section 4.1 should be consulted~~ to determine which requirements apply to any given project. ~~See Figure 4.1 and Figure 4.2 should be consulted~~ to determine whether the minimum requirements apply to new surfaces, replaced surfaces, or new and replaced surfaces. Volume II ~~of this manual~~ presents BMPs for use in meeting the minimum requirements.

4.2.1 Minimum Requirement #1: Preparation of Stormwater Site Plans

All projects meeting the thresholds in [Volume I, Section 4.1](#) shall prepare a Stormwater Site Plan for review. Stormwater Site Plans shall use site-appropriate development principles, as required and encouraged by Kitsap County Codes, to retain native vegetation and minimize impervious surfaces to the extent feasible. Stormwater Site Plans shall be prepared in accordance with Volume II, Chapter 1 – Plans and Reports.

Documents provided by Kitsap County Public Works must clearly show how the project complies with the technical requirements of this manual and [Title 12 KCC](#), but may vary in form and content contained in Volume II, Chapter 1 – Plans and Reports, as indicated in [KCC Section 21.04.020](#).

4.2.2 Minimum Requirement #2: Construction Stormwater Pollution Prevention Plan (SWPPP)

All new development and redevelopment projects are responsible for preventing erosion and discharge of sediment and other pollutants into receiving waters.

Projects that result in 2,000 square feet or more of new plus replaced hard surface area, or that disturb 7,000 square feet or more of land must prepare a Construction [SWPP Stormwater Pollution Prevention](#) Plan (SWPPP) as part of the Stormwater Site Plan (see [Volume 1](#), Section 4.2.1).

Projects ~~that result in less than 2,000 square feet of new plus replaced hard surface area, or disturb less than 7,000 square feet of land below those thresholds (listed above)~~ are not required to prepare a Construction SWPPP, but must consider all of the ~~13 Elements of Construction Stormwater Pollution Prevention (see the Project Requirements—~~ Construction SWPPP elements (~~section listed~~ below) and develop controls for all [Construction SWPPP](#) elements that pertain to the project site.

4.2.2.1 General Requirements

The [Construction](#) SWPPP shall include a narrative and drawings that describe and reference all BMPs to be implemented. The [Construction](#) SWPPP narrative shall include documentation to explain and justify the pollution prevention decisions made for the project. Each of the 13 [Construction SWPPP](#) elements ~~below~~ must be considered and included in the Construction SWPPP unless site conditions render the element unnecessary and the exemption from that element is clearly justified in the narrative of the SWPPP.

Clearing and grading activities for developments shall be permitted only if conducted pursuant to an approved SDAP in accordance with [KCC Section 12.10.030](#). These permitted clearing and grading areas and any other areas required to preserve critical or sensitive areas, buffers, native growth protection easements, or tree retention areas, shall be delineated on the site plans and the development site.

The [Construction](#) SWPPP shall be implemented beginning with initial land disturbance and until final stabilization. Sediment and erosion control BMPs shall be consistent with the BMPs contained in [Volume II](#), Chapters ~~2 of Volume II of this manual~~.

4.2.2.2 Seasonal Work Limitations

[Seasonal Work Limitations](#): From October 1 through April 30 (typically the wet season), clearing, grading, and other soil disturbing activities shall only be permitted if shown to the satisfaction of the director that silt-laden runoff will be prevented from leaving the site through a combination of the following:

- Site conditions including existing vegetative coverage, slope, soil type and proximity to receiving waters, ~~and-~~
- Limitations on activities and the extent of disturbed areas, ~~and-~~
- Proposed erosion and sediment control measures.

The following activities are exempt from the seasonal clearing and grading limitations:

- Routine maintenance and necessary repair of erosion and sediment control BMPs.
- Routine maintenance of public facilities or existing utility structures that do not expose the soil or result in the removal of the vegetative cover to soil.
- Activities where there is 100% infiltration of surface water runoff within the site in approved and installed erosion and sediment control facilities.

4.2.2.34.2.2.2 Project Requirements—Construction SWPPP Elements

Element 1: Preserve Vegetation/Mark Clearing Limits

- Before beginning land disturbing activities, including clearing and grading, clearly mark all clearing limits, sensitive areas and their buffers, and trees that are to be preserved within the construction area.
- Retain the duff layer, native ~~top soil~~topsoil, and natural vegetation in an undisturbed state to the maximum degree practicable.

Element 2: Establish Construction Access

- Limit construction vehicle access and exit to one route, if possible.
- Stabilize access points with a pad of quarry spalls, crushed rock, or other equivalent BMPs, to minimize tracking of sediment onto public roads.
- Locate wheel wash or tire baths on site, if the stabilized construction entrance is not effective in preventing tracking sediment onto roads.
- If sediment is tracked off site, clean the affected roadway(s) thoroughly at the end of each day, or more frequently as necessary (for example, during wet weather). Remove sediment from roads by shoveling, vacuum sweeping, or picking up and transporting the sediment to a controlled sediment disposal area.
- Conduct street washing only after sediment is removed in accordance with the above bullet.
- Control street wash wastewater by pumping back on site, or otherwise prevent it from discharging into systems tributary to waters of the State.

Element 3: Control Flow Rates

- Protect properties and waterways downstream of development sites from erosion and the associated discharge of turbid waters due to increases in the velocity and peak volumetric flow rate of stormwater runoff from the project site.
- Where necessary to comply with the bullet above, construct stormwater retention infiltration or detention BMPs facilities as one of the first steps in grading. Ensure that detention facilities function properly before constructing site improvements (e.g., impervious surfaces).
- If permanent infiltration ponds-BMPs are used for temporary flow control during construction, protect these facilities from siltation during the construction phase.

Element 4: Install Sediment Controls

Design, install, and maintain effective erosion [controls](#) and sediment controls to minimize the discharge of pollutants.

- Construct sediment control BMPs (sediment ponds, traps, filters, etc.) as one of the first steps in grading. These BMPs ~~shall~~[must](#) be functional before other land disturbing activities take place.
- Minimize sediment discharges from the site. The design, installation and maintenance of erosion and sediment controls must address factors such as the amount, frequency, intensity and duration of precipitation, the nature of resulting stormwater runoff, and soil characteristics, including the range of soil particle sizes expected to be present ~~on~~[on the](#) site.
- Direct stormwater runoff from disturbed areas through ~~a sediment pond~~[BMP C241: Sediment Pond \(Temporary\)](#) or other appropriate sediment removal BMP, before the runoff leaves a construction site or before discharge to an infiltration facility. Runoff from fully stabilized areas may be discharged without a sediment removal BMP, but must ~~meet the control~~ flow ~~control performance standard in~~[rates per](#) Element #3, Bullet #1.
- [Locate BMPs intended to trap sediment on site in a manner to avoid interference with the movement of juvenile salmonids attempting to enter off-channel areas or drainages.](#)
- [Provide and maintain natural buffers around surface waters, direct stormwater to vegetated areas to increase sediment removal and maximize stormwater infiltration, unless infeasible.](#)
- Where feasible, design outlet structures that withdraw impounded stormwater from the surface to avoid discharging sediment that is still suspended lower in the water column.

Element 5: Stabilize Soils

- Stabilize exposed and unworked soils by application of effective BMPs that prevent erosion. Applicable BMPs include, but are not limited to: temporary and permanent seeding, sodding, mulching, plastic covering, erosion control fabrics and matting, soil application of polyacrylamide (PAM) ~~or Bonded Fiber Matrix (BFM)~~, the early application of gravel base ~~early~~ on areas to be paved, and dust control.
- Control stormwater volume and velocity within the site to minimize soil erosion.
- Control stormwater discharges, including both peak flow rates and total stormwater volume, to minimize erosion at outlets and to minimize downstream channel and stream bank erosion.
- Soils ~~shall~~[must](#) not remain exposed and unworked for more than the time periods set forth below to prevent erosion:

- During the dry season (May 1–Sept-~~ember~~ 30): 7 days
- During the wet season (October 1–April 30): 2 days
- Stabilize soils at the end of the shift before a holiday or weekend if needed based on the weather forecast.
- Stabilize soil stockpiles from erosion, protected with sediment trapping measures, and where possible, be-located away from storm drain inlets, waterways and drainage channels.
- Minimize the amount of soil exposed during construction activity.
- Minimize the disturbance of steep slopes.
- Minimize soil compaction and, unless infeasible, preserve topsoil.

Element 6: Protect Slopes

- Design and construct cut-and-fill slopes in a manner to minimize erosion. Applicable practices include, but are not limited to, reducing continuous length of slope with terracing and diversions, reducing slope steepness, and roughening slope surfaces (e.g., track walking).
- Divert offsite stormwater (run-on) or ground water away from slopes and disturbed areas with interceptor dikes, pipes and/or swales. Manage offsite stormwater should be managed separately from stormwater generated on ~~the~~ site.
- At the top of slopes, collect drainage in pipe slope drains or protected channels to prevent erosion. Temporary pipe slope drains must be sized to convey the flow rate calculated by one of the following methods:
 - ~~Temporary pipe slope drains must handle~~ Single Event Hydrograph Method: The peak volumetric flow rate calculated using a 10-minute time step from a Type 1A, 10-year, 24-hour frequency storm ~~for the developed condition.~~

OR

- Continuous Simulation Method: Alternatively, the 10-year and ~~4-hour~~ peak flow rate, as determined predicted by an approved continuous runoff model, ~~increased by a factor of 1.6, may be used with a 15-minute time step.~~

The hydrologic analysis must use the existing land cover condition for predicting flow rates from tributary areas outside the project limits. For tributary areas on the project site, the analysis must use the temporary or permanent project land cover condition, whichever will produce the highest flow rates. If using the Western Washington Hydrology Model (WWHM) to predict flows, model bare soil areas ~~should be modeled~~ as “landscaped” area.

- Place excavated material on the uphill side of trenches, consistent with safety and space considerations.

- Place check dams at regular intervals within constructed channels that are cut down a slope.

Element 7: Protect Drain Inlets

- Protect all storm drain inlets made operable during construction so that stormwater runoff ~~shall~~ does not enter the conveyance system without first being filtered or treated to remove sediment.
- Clean or remove and replace inlet protection devices when sediment has filled one-third of the available storage (unless a different standard is specified by the product manufacturer).

Element 8: Stabilize Channels and Outlets

- Design, construct, and stabilize all onsite conveyance channels to prevent erosion from the flow rate calculated by one of the following ~~expected peak flows~~ methods:
 - ~~Channels must handle the~~ Single Event Hydrograph Method: The peak volumetric flow rate calculated using a 10-minute ~~velocity of flow~~ time step from a Type 1A, 10-year, 24-hour frequency storm ~~for the developed condition~~.
 - Continuous Simulation Method: Alternatively, the 10-year, ~~1-hour~~ peak flow rate, ~~indicated as determined~~ by an approved continuous runoff model, ~~increased by a factor of 1.6, may be used with a 15-minute time step~~.

The hydrologic analysis must use the existing land cover condition for predicting flow rates from tributary areas outside the project limits. For tributary areas on the project site, the analysis must use the temporary or permanent project land cover condition, whichever will produce the highest flow rates. If using WWHM to predict flows, model bare soil areas ~~should be modeled~~ as “landscaped” area.

- Provide stabilization, including armoring material, adequate to prevent erosion of outlets, adjacent stream banks, slopes and downstream reaches at the outlets of all conveyance systems.

Element 9: Control Pollutants

Design, install, implement and maintain effective pollution prevention measures to minimize the discharge of pollutants. The project proponent must:

- Handle and dispose of all pollutants, including waste materials and demolition debris that occur on site in a manner that does not cause contamination of stormwater.
- Provide cover, containment, and protection from vandalism for all chemicals, liquid products, petroleum products, and other materials that have the potential to pose a threat to human health or the environment. Onsite fueling tanks must include secondary containment. Secondary containment means placing tanks or containers within an impervious structure capable of containing 110% of the volume contained in the largest tank within the containment structure. Double-walled tanks do not require additional secondary containment.

- Conduct maintenance, fueling, and repair of heavy equipment and vehicles using spill prevention and control measures. Such activities shall be carried out no closer than 100 feet from an open channel or stream. Clean contaminated surfaces immediately following any spill incident.
- Discharge wheel wash or tire bath wastewater to a separate onsite treatment system that prevents discharge to surface water, ~~such as closed-loop recirculation or upland application,~~ or to the sanitary sewer, with local sewer district approval.
- Apply fertilizers and pesticides in a manner and at application rates that will not result in loss of chemical to stormwater runoff. Follow manufacturers' label requirements for application rates and procedures.
- Use BMPs to prevent contamination of stormwater runoff by pH modifying sources. The sources for this contamination include, but are not limited to: recycled concrete stockpiles, bulk cement, cement kiln dust, fly ash, new concrete washing and curing waters, waste streams generated from concrete grinding and sawing, exposed aggregate processes, dewatering concrete vaults, concrete pumping and mixer washout waters.
- Adjust the pH of stormwater if necessary to prevent violations of water quality standards.
- Ensure that washout of concrete trucks is performed off site or in designated concrete washout areas only. Do not wash out concrete ~~trucks-truck drums or~~ concrete handling equipment onto the ground, or into storm drains, open ditches, streets, or streams. Washout of small concrete handling equipment may be disposed of in a formed area awaiting concrete where it will not contaminate surface or ground water. Do not dump excess concrete on site, except in designated concrete washout areas. Concrete spillage or concrete discharge directly to ground water or to surface waters of the State is prohibited. Do not wash out to formed areas awaiting infiltration BMPs.
- Obtain written approval from Ecology before using chemical treatment other than carbon dioxide (CO₂), ~~or~~ dry ice, or food grade vinegar to adjust pH.
- Uncontaminated water from water-only based shaft drilling for construction of building, road, and bridge foundations may be infiltrated provided the wastewater is managed in a way that prohibits discharge to surface waters. Prior to infiltration, water from water-only based shaft drilling that comes into contact with curing concrete must be neutralized until pH is in the range of 6.5 to 8.5 (su).

Element 10: Control De-Watering

- Discharge foundation, vault, and trench de-watering water, which ~~has~~ have similar characteristics to stormwater runoff at the site, into a controlled conveyance system before discharge to a-BMP C240: Sediment Trap or BMP C241: Sediment Pond (Temporary).

- Discharge clean, non-turbid de-watering water, such as well-point ground water, to systems tributary to, or directly into surface waters of the State, as specified in Element #8, provided the de-watering flow does not cause erosion or flooding of receiving waters. Do not route clean dewatering water through stormwater sediment pondsBMPs. Note that “surface waters of the State” may exist on a construction site as well as off site; for example, a creek running through a site.
- Handle highly turbid or otherwise contaminated dewatering water separately from stormwater.
- Other [dewatering](#) treatment or disposal options may include:
 - Infiltration.
 - Transport off site in a vehicle, such as a vacuum flush truck, for legal disposal in a manner that does not pollute state waters.
 - Ecology-approved onsite chemical treatment or other suitable treatment technologies.
 - Sanitary or combined sewer discharge with local sewer district approval, if there is no other option.
 - Use of a sedimentation bag that discharges to a ditch or swale for small volumes of localized dewatering.

Element 11: Maintain BMPs

- Maintain and repair all temporary and permanent erosion and sediment control BMPs as needed to ensure continued performance of their intended function in accordance with BMP specifications.
- Remove all temporary erosion and sediment control BMPs within 30 days after achieving final site stabilization or after the temporary BMPs are no longer needed.

Element 12: Manage the Project

- Phase development projects to the maximum degree practicable and take into account seasonal work limitations.
- Inspect, maintain and repair all BMPs as needed to ensure continued performance of their intended function. Projects regulated under the Construction Stormwater General Permit ([CSWGP](#)) must conduct site inspections and monitoring in accordance with Special Condition S4 of the [Construction Stormwater General PermitCSWGP](#).
- Maintain, update, and implement the Construction SWPPP.
- ~~For p~~Projects that disturb 1 or more acres [must have](#), site inspections shall be conducted by a Certified Erosion and Sediment Control Lead (CESCL). Project sites disturbing less than 1 acre may have a CESCL or a person without CESCL certification conduct inspections. By the initiation of construction, the [Construction](#)

SWPPP must identify the CESCL or inspector, who must be present on site or on-call at all times.

- The CESCL or inspector (project sites less than 1 acre) must have the skills to assess the:
 - Site conditions and construction activities that could impact the quality of stormwater.
 - Effectiveness of erosion and sediment control measures used to control the quality of stormwater discharges.
- The CESCL or inspector must examine stormwater visually for the presence of suspended sediment, turbidity, discoloration, and oil sheen. They must evaluate the effectiveness of BMPs and determine if it is necessary to install, maintain, or repair BMPs to improve the quality of stormwater discharges.
- Based on the results of the inspection, construction site operators must correct the problems identified by:
 - Reviewing the SWPPP for compliance with the 13 construction SWPPP elements and making appropriate revisions within 7 days of the inspection.
 - Immediately beginning the process of fully implementing and maintaining appropriate source control and/or treatment BMPs as soon as possible, addressing the problems not later than within 10 days of the inspection. If installation of necessary treatment BMPs is not feasible within 10 days, the construction site operator may request an extension within the initial 10-day response period.
 - Documenting BMP implementation and maintenance in the site log book (sites larger than 1 acre).
- The CESCL or inspector must inspect all areas disturbed by construction activities, all BMPs, and all stormwater discharge [points-locations](#) at least once every calendar week and within 24 hours of any discharge from the site. (For purposes of this condition, individual discharge events that last more than 1 day do not require daily inspections. For example, if a stormwater pond discharges continuously over the course of a week, only one inspection is required that week.) Project BMPs shall also be inspected within 24 hours of a rain event that exceeds 0.5 inch in a 24-hour period. The CESCL or inspector may reduce the inspection frequency for temporary stabilized, inactive sites to once every calendar month.
- If a Construction SWPPP is found to be inadequate (with respect to erosion and sediment control requirements), then other BMPs may be required to be implemented, as appropriate. Construction is a complex and ever-changing process. The SWPPP shall be treated as a “living document” and shall be modified as needed during the construction process. All parties involved shall agree on the changes and acknowledge this on the master SWPPP kept at the project site.
- For small residential projects, a narrative checklist and site plan template can be used in lieu of preparing a full Construction SWPPP. Consult with DCD to determine

if a project qualifies for this and for a copy of the narrative checklist and site plan template.

- Based on the information provided and/or local weather conditions, seasonal limitations on site disturbance may be expanded or restricted.
- The applicant shall evaluate, with input from utilities and other contractors, the stormwater management requirements for the entire project, including the utilities, when preparing the Construction SWPPP.

Element 13: Protect Low Impact Development BMPs

The primary purpose of Onsite Stormwater Management is to reduce the disruption of the natural site hydrology through infiltration. BMPs used to meet I-3.4.5 MR5: Onsite Stormwater Management (often called LID BMPs) are permanent facilities.

- Protect all LID BMPs (including, but not limited to Bioretention, and Rain Gardens, and Permeable Pavements) from sedimentation through the installation and maintenance of erosion and sediment control BMPs on portions of the site that drain into the bioretention and/or rain gardens LID BMPs. Restore the BMPs to their fully functioning condition if they accumulate sediment during construction. Restoring the BMP must include removal of sediment and any sediment-laden Bioretention/Rain Garden soils, and replacing the removed soils with soils meeting the design specification.
- Maintain the infiltration capabilities of LID BMPs by protecting against compaction by construction equipment and foot traffic. Prevent compacting bioretention and rain gardens by excluding construction equipment and foot traffic. Protect completed lawn and landscaped areas from compaction due to construction equipment.
- Control erosion and avoid introducing sediment from surrounding land uses onto Permeable Pavements. Do not allow muddy construction equipment on the base material or pavement. Do not allow sediment-laden runoff onto permeable pavements or base materials.
- Clean Permeable pavement fouled with sediments or no longer passing an initial infiltration test must be cleaned using procedures in accordance with this manual or the manufacturer's procedures.
- Keep all heavy equipment off existing soils under LID facilities-BMPs that have been excavated to final grade to retain the infiltration rate of the soils.

4.2.3 Minimum Requirement #3: Source Control of Pollution

Source control BMPs help prevent stormwater from coming in contact with pollutants. They are a cost-effective means of reducing pollutants in stormwater, and, therefore, should be a first consideration in all projects.

All known, available and reasonable source control BMPs shall be applied to all projects. Source control BMPs shall be selected, designed, and maintained according to Volume II, Chapter 3 ~~of this manual~~.

4.2.4 Minimum Requirement #4: Preservation of Natural Drainage Systems and Outfalls

Natural drainage patterns shall be maintained, and discharges from the project site shall occur at the natural location, to the maximum extent practicable. The manner by which runoff is discharged from the project site must not cause a significant adverse impact to downstream receiving waters and downgradient properties. All outfalls require energy dissipation ([see Volume II, Section 4.2.2](#)).

Creating new drainage patterns results in more site disturbance and more potential for erosion and sedimentation during and after construction. Creating new discharge ~~points~~ locations can create significant stream channel erosion problems as the receiving water body typically must adjust to the new flows. Diversions can cause greater impacts than would otherwise occur by discharging runoff at the natural location.

Where no conveyance system exists at the adjacent downgradient property line and the discharge was previously unconcentrated flow or significantly lower concentrated flow, then measures must be taken to prevent downgradient impacts. Drainage easements from downstream property owners may be needed and ~~shall~~ should be obtained prior to approval of engineering plans.

Volume II, Chapter 4 provides detailed design requirements for conveyance ~~facilities~~ systems and outfall systems to protect against adverse impacts from concentrated stormwater runoff. Volume II, Chapter 4 also provides standards for downstream analyses, including when a downstream analysis is required, the level of analysis that must be performed, and documentation requirements.

4.2.5 Minimum Requirement #5: Onsite Stormwater Management

Projects shall employ Onsite Stormwater Management BMPs in accordance with the following project thresholds, standards, and lists to infiltrate, disperse, and retain stormwater runoff on site to the extent feasible without causing flooding or erosion impacts.

4.2.5.1 Project Thresholds

Different compliance paths for meeting Minimum Requirement #5 are available depending on whether the project is a small project or a large project per the definitions in [Chapter 12.08 KCC](#).

Small Projects that Trigger Only Minimum Requirements #1–#5

Small projects for which not all of the nine minimum requirements apply ([Chapter 12.08 KCC](#)) shall either:

- [Use any Flow Control BMP\(s\) desired to achieve the LID Performance Standard \(see the LID Performance Standard provided below\) and apply Post-Construction Soil](#)

Quality and Depth. Project proponents selecting this option cannot use Rain Gardens. They may choose to use Bioretention as described in Volume II, Chapter 5 and Volume V, Chapter 5 of the Ecology Manual to achieve the LID Performance Standard.

or

- Use LID On-site Stormwater Management BMPs from List #1 (Table 4.3 below) for all surfaces within each type of surface included in ~~the list~~ List #1;

or

- ~~Demonstrate compliance with the LID Performance Standard (see the LID Performance Standard provided below). Projects selecting this option cannot use Rain Gardens. They may choose to use Bioretention BMPs as described in Volume II, Chapter 5 of this manual and Chapter 7 of Volume V, Chapter 5 of the Ecology Manual to achieve the LID Performance Standard.~~

Large Projects that Trigger Minimum Requirements #1–#9

Large projects for which all nine minimum requirements apply (Chapter 12.08 KCC) shall meet the requirements in Table 4.2. Note that the requirements for large projects differ based on whether or not the project is located inside a UGA, a Census Urbanized Area (UA), or a rural area located outside both the UGA and UA. Refer to the UGA, UA, and rural area mapping available on the County’s Community Development Maps/GIS web page.

Table 4.2 – Onsite Stormwater Management Requirements (MR #5) for Large Projects a,b	
Project Type and Location	Requirement
Inside UGA or UA	
New development on any parcel inside the UGA, or new development inside a UA on a parcel less than 5 acres	Applicant option: <ul style="list-style-type: none"> • LID Performance Standard and BMP T5.13 Post-Construction Soil Quality and Depth; or • List #2^c
New development outside the UGA but inside a UA on a parcel of 5 acres or larger	LID Performance Standard and <u>Post-Construction Soil Quality and Depth</u> BMP T5.13
Redevelopment on any parcel inside the UGA, or redevelopment outside a UGA but inside a UA on a parcel less than 5 acres	Applicant option: <ul style="list-style-type: none"> • LID Performance Standard and BMP T5.13 Post-Construction Soil Quality and Depth; or • List #2^c
Redevelopment outside the UGA but inside a UA on a parcel 5 acres or larger	LID Performance Standard and <u>Post-Construction Soil Quality and Depth</u> BMP T5.13
Outside UGA and UA <u>[Rural Areas]</u>	
New development	Applicant option:

Table 4.2 – Onsite Stormwater Management Requirements (MR #5) for Large Projects
a,b

Project Type and Location	Requirement
Redevelopment	<ul style="list-style-type: none"> • BMP T5.30 Full Dispersion; or • LID Performance Standard and BMP T5.13 Post-Construction Soil Quality and Depth; or • List # 23

Notes:

- ^a This table refers to the UGA as designated under the Growth Management Act (GMA) (Chapter 36.70A RCW) of the State of Washington, the Census Urbanized Areas (UA) map, and the rural areas located outside both UGA and UA. Refer to the available UGA, UA, and rural area mapping available on the County's [Community Development Maps/GIS web page](#).
- ^b Large projects are defined as those that trigger Minimum Requirements #1 through #9, per [Chapter 12.08 KCC](#).
- ^c See List #2 ~~provided in the text below~~.
- ^d ~~See List #3 provided in the text below~~

Flow Control Exempt Projects

Projects qualifying as flow control exempt in accordance with MR #7 shall either:

- Use LID BMPs from List #3 (Table 4.3) for all surfaces within each type of surface included in List #3;
- or
- Use any Flow Control BMP(s) desired to achieve the LID Performance Standard (see the LID Performance Standard provided below) and apply Post-Construction Soil Quality and Depth.

Note: If the project has multiple TDAs, all TDAs must be Flow Control exempt per MR #7 for the project to use these options.

4.2.5.2 Low Impact Development Performance Standard

The LID Performance Standard compliance method for Minimum Requirement #5 requires modeling the proposed flow control BMPs to demonstrate the flow reduction as described below. Note that in order to meet the LID Performance Standard, the chosen flow control BMPs will most likely need to include infiltration. Drainage design using the LID Performance Standard shall be performed by or under the direction of a professional engineer licensed to practice in Washington State.

Stormwater discharges shall match developed discharge durations to pre-developed durations for the range of pre-developed discharge rates from 8% of the 2-year peak flow to 50% of the 2-year peak flow. Refer to the section titled “Standard Flow Control Requirements” in Section 4.2.7 below for information about the assignment of the pre-developed condition. Project sites that must also meet Minimum Requirement #7 must match flow durations between 8% of the 2-year flow through the full 50-year flow.

Designers selecting this option cannot use Rain Gardens to achieve the LID Performance Standard. They may choose to use Bioretention to achieve the LID Performance Standard.

4.2.5.3 The List Approach

The List Approach compliance method for Minimum Requirements #5 requires evaluating the BMPs in Table 4.3.

For each surface type (e.g., lawn and landscaped areas, roofs, and other hard surfaces), evaluate the feasibility of consider the BMPs in the order listed below for that type of surface, and use the first BMP that is considered feasible for each surface. Once a BMP is deemed feasible and used for a surface, no other On-site Stormwater Management BMP from the list is necessary for that surface.

If all BMPs in the list are infeasible, then the designer must document the site conditions and infeasibility criteria used to deem each BMP infeasible. This documentation will demonstrate compliance with Minimum Requirement #5.

Feasibility shall be determined by evaluation against:

1. Design criteria, limitations, and infeasibility criteria identified for each BMP in Volume II, Chapter 5 of this manual; and
2. Competing Needs Criteria listed in Volume I, Section 3.4.5 of the Ecology Manual.

Table 4.3 – The List Approach for Minimum Requirement #5 Compliance.		
<u>List #1</u> <u>(small projects that trigger MR #1–5)</u>	<u>List #2</u> <u>(large projects that trigger MR #1–9)</u>	<u>List #3</u> <u>(flow control exempt projects)</u>
Surface Type: Lawn and Landscaped Areas		
<u>Post-Construction Soil Quality and Depth</u>	<u>Post-Construction Soil Quality and Depth</u>	<u>Post-Construction Soil Quality and Depth</u>
Surface Type: Roofs		
1. <u>Full Dispersion or Downspout Full Infiltration</u>	1. <u>Full Dispersion or Downspout Full Infiltration</u>	1. <u>Downspout Full Infiltration</u>
2. <u>Bioretention or Rain Gardens</u>	2. <u>Bioretention</u>	
3. <u>Downspout Dispersion Systems</u>	3. <u>Downspout Dispersion Systems</u>	2. <u>Downspout Dispersion Systems</u>
4. <u>Perforated Stub-out Connections</u>	4. <u>Perforated Stub-out Connections</u>	3. <u>Perforated Stub-out Connections</u>
Surface Type: Other Hard Surfaces		
1. <u>Full Dispersion</u>	1. <u>Full Dispersion</u>	<u>Sheet Flow Dispersion or Concentrated Flow Dispersion</u>
2. <u>Permeable Pavements or Bioretention</u>	2. <u>Permeable Pavements (not required for rural residential areas)</u>	

Table 4.3 – The List Approach for Minimum Requirement #5 Compliance.

<u>List #1</u> (small projects that trigger MR #1–5)	<u>List #2</u> (large projects that trigger MR #1–3)	<u>List #3</u> (flow control exempt projects)
or Rain Gardens	3. Bioretention	
3. Sheet Flow Dispersion or Concentrated Flow Dispersion	4. Sheet Flow Dispersion or Concentrated Flow Dispersion	

Notes for using the List Approach:

1. [Size Rain Gardens and Bioretention used in the List Approach to have a minimum horizontal projected surface area below the overflow, which is at least 5% of the area draining to it.](#)
2. [When the designer encounters Permeable Pavements in the List Approach, it is not a requirement to pave these surfaces. Where pavement is proposed, it must be permeable to the extent feasible unless Full Dispersion is employed.](#)

3. [This table refers to the UGA as designated under the Growth Management Act \(GMA\) \(Chapter 36.70A RCW\) of the State of Washington, the Census Urbanized Areas \(UA\) map, and the rural areas located outside both UGA and UA. Refer to the available UGA, UA, and rural area mapping available on the County's Community Development Maps/GIS web page](#)

Figure 4.3 – Flow Chart for Determining LID-MR #5 Requirements.



4.2.5.3 List #1: On-site Stormwater Management BMPs for Projects Triggering Minimum Requirements #1 through #5

Lawn and landscaped areas:

1. ~~Post-Construction Soil Quality and Depth in accordance with Volume II, Chapter 5 of this manual and in Volume V, Chapter 5 of the Ecology Manual.~~

Roofs:

1. ~~Full Dispersion in accordance with Volume II, Chapter 5 of this manual and BMP T5.30 in Volume V, Chapter 5 of the Ecology Manual, or Downspout Full Infiltration Systems in accordance with Volume II, Chapter 5 of this manual and BMP T5.10A in Volume III, Section 3.1.1 of the Ecology Manual.~~
2. ~~Rain Gardens in accordance with Volume II, Chapter 5 of this manual and BMPT5.14A in Chapter 5 of Volume V in the Ecology Manual, or Bioretention in accordance with Volume II, Chapter 5 of this manual and Volume V, Chapter 7 of the Ecology Manual. The rain garden or bioretention facility must have a minimum horizontal projected surface area below the overflow which is at least 5% of the area draining to it.~~
3. ~~Downspout Dispersion Systems in accordance with Volume II, Chapter 5 of this manual and BMP T5.10B in Volume III, Section 3.1.2 of the Ecology Manual.~~
4. ~~Perforated Stub-out Connections in accordance with Volume II, Chapter 5 of this manual and BMP T5.10C in Volume III, Section 3.1.3 of the Ecology Manual.~~

Other Hard Surfaces:

1. ~~Full Dispersion in accordance with Volume II, Chapter 5 of this manual and BMP T5.30 in Volume V, Chapter 5 of the Ecology Manual.~~
2. ~~Permeable pavement¹ in accordance with Volume II, Chapter 5 of this manual and BMP T5.15 in Volume V, Chapter 5 of the Ecology Manual, or Rain Gardens in accordance with Volume II, Chapter 5 of this manual and BMP T5.14 in Volume V, Chapter 5 of the Ecology Manual, or Bioretention in accordance with Volume II, Chapter 5 of this manual and Volume V, Chapter 7 of the Ecology Manual. The rain garden or bioretention facility must have a minimum horizontal projected surface area below the overflow which is at least 5% of the area draining to it.~~
3. ~~Sheet Flow Dispersion in accordance with Volume II, Chapter 5 of this manual and BMP T5.12, or Concentrated Flow Dispersion in accordance with Volume II, Chapter 5 of this manual and BMP T5.11 in Volume V, Chapter 5 of the Ecology Manual.~~

¹This is not a requirement to pave these surfaces. Where pavement is proposed, it must be permeable to the extent feasible unless full dispersion is employed.

4.2.5.4 List #2: On-site Stormwater Management BMPs for Projects Triggering Minimum Requirements #1 through #9 – Inside UGA or Inside UA on Parcel Less Than 5 Acres

For each surface (lawn and landscaped areas, roofs, and other hard surfaces), consider the BMPs in the order listed for that type of surface. Use the first BMP that is considered feasible. No other On-site Stormwater Management BMP is necessary for that surface.

Feasibility shall be determined by evaluation against:

- ~~1. Design criteria, limitations, and infeasibility criteria identified for each BMP in Volume II, Chapter 5 of this manual; and~~
- ~~2. Competing Needs Criteria listed in Volume V, Chapter 5 of the Ecology Manual.~~

Lawn and landscaped areas:

- ~~1. Post-Construction Soil Quality and Depth in accordance with Volume II, Chapter 5 of this manual and BMP T5.13 in Volume V, Chapter 5 of the Ecology Manual.~~

Roofs:

- ~~1. Full Dispersion in accordance with Volume II, Chapter 5 of this manual and BMP T5.30 in Volume V, Chapter 5 of the Ecology Manual, or Downspout Full Infiltration Systems in accordance with Volume II, Chapter 5 of this manual and BMP T5.10A in Volume III, Section 3.1.1 of the Ecology Manual.~~
- ~~2. Bioretention (See Volume II, Chapter 5 of this manual and BMP T7.30 in Volume V, Chapter 5 of the Ecology Manual) facilities that have a minimum horizontally projected surface area below the overflow which is at least 5% of the total surface area draining to it.~~
- ~~3. Downspout Dispersion Systems in accordance with Volume II, Chapter 5 of this manual and BMP T5.10B in Volume III, Section 3.1.2 of the Ecology Manual.~~
- ~~4. Perforated Stub-out Connections in accordance with Volume II, Chapter 5 and BMP T5.10C in Section 3.1.3 in Chapter 3 of Volume III, Section 3.1.3 of the Ecology Manual.~~

Other Hard Surfaces:

- ~~1. Full Dispersion in accordance with Volume II, Chapter 5 of this manual and BMP T5.30 in Volume V, Chapter 5 of the Ecology Manual.~~
- ~~2. Permeable pavement in accordance with Volume II, Chapter 5 of this manual and BMP T5.15 in Volume V, Chapter 5 of the Ecology Manual.~~
- ~~3. Bioretention BMPs (See Volume II, Chapter 5 and BMP T7.30 in Volume V, Chapter 7 of the Ecology Manual) that have a minimum horizontally projected surface area below the overflow which is at least 5% of the total surface area draining to it.~~
- ~~4. Sheet Flow Dispersion in accordance with Volume II, Chapter 5 and BMP T5.12, or Concentrated Flow Dispersion in accordance with Volume II, Chapter 5 of this manual and BMP T5.11 in Volume V, Chapter 5 of the Ecology Manual.~~

4.2.5.5 — List #3: On-site Stormwater Management BMPs for Projects Triggering Minimum Requirements #1 through #9 — Outside UA and UGA

For each surface (lawn and landscaped areas, roofs, and other hard surfaces), consider the BMPs in the order listed for that type of surface. Use the first BMP that is considered feasible. No other On-site Stormwater Management BMP is necessary for that surface.

Feasibility shall be determined by evaluation against:

1. ~~Design criteria, limitations, and infeasibility criteria identified for each BMP in Volume II, Chapter 5 of this manual; and~~
2. ~~Competing Needs Criteria listed in Volume V, Chapter 5 of the Ecology Manual.~~

Lawn and landscaped areas:

1. ~~Post Construction Soil Quality and Depth in accordance with Volume II, Chapter 5 of this manual and BMP T5.13 in Volume V, Chapter 5 of the Ecology Manual.~~

Roofs:

1. ~~Downspout Full Infiltration Systems in accordance with Volume II, Chapter 5 of this manual and BMP T5.10A in Volume III, Section 3.1.1 of the Ecology Manual.~~
2. ~~Bioretention (Volume II, Chapter 5 of this manual and Chapter 7 of Volume V, Chapter 5 of the Ecology Manual) facilities that have a minimum horizontally projected surface area below the overflow which is at least 5% of the total surface area draining to it.~~
3. ~~Downspout Dispersion Systems in accordance with Volume II, Chapter 5 of this manual and BMP T5.10B in Volume III, Section 3.1.2 of the Ecology Manual.~~
4. ~~Perforated Stub-out Connections in accordance with Volume II, Chapter 5 of this manual and BMP T5.10C in Volume III, Section 3.1.3 of the Ecology Manual.~~

Other Hard Surfaces:

1. ~~Permeable pavement in accordance with Volume II, Chapter 5 of this manual and BMP T5.15 in Volume V, Chapter 5 of the Ecology Manual.~~
2. ~~Bioretention BMPs (See Volume II, Chapter 5 of this manual and BMP T7.30 in Volume V, Chapter 7 of the Ecology Manual) that have a minimum horizontally projected surface area below the overflow which is at least 5% of the total surface area draining to it.~~
3. ~~Sheet Flow Dispersion in accordance with Volume II, Chapter 5 of this manual and BMP T5.12, or Concentrated Flow Dispersion in accordance with Volume II, Chapter 5 of this manual and BMP T5.11 in Volume V, Chapter 5 of the Ecology Manual.~~

4.2.5.6 — Exemptions

Projects qualifying as flow control exempt in accordance with Section 4.2.7 of this chapter must implement the following BMPs:

- ~~Post Construction Soil Quality and Depth (BMP T5.13 in Volume V, Chapter 5 of the Ecology Manual);~~

- ~~Downspout Full Infiltration Systems (BMP T5.10A), Downspout Dispersion Systems (BMP T5.10B), or Perforated Stub-out Connections (BMP T5.10C) (Volume III, Chapter 3 of the Ecology Manual), if feasible; and~~
- ~~Concentrated Flow Dispersion (BMP T5.11) or Sheet Flow Dispersion (BMP T5.12) (Volume V, Chapter 5 of the Ecology Manual), if feasible.~~

~~Qualifying exempt projects do not have to achieve the LID performance standard, nor consider bioretention, rain gardens, permeable pavement, or full dispersion.~~

4.2.6 Minimum Requirement #6: Runoff Treatment

4.2.6.1 Thresholds

When assessing a project against the following thresholds, only consider those hard and pervious surfaces that are subject to this minimum requirement as determined in Section 4.1 of this chapter.

The following require construction of **runoff/stormwater** treatment facilities:

- Projects in which the total of PGHS is 5,000 square feet or more, or;
- Projects in which the total of PGPS—not including permeable pavements—is 3/4 of an acre or more, and from which there will be a surface discharge in a natural or manmade conveyance system from the site.

~~The use of Threshold Discharge Areas (TDAs) detailed in the Ecology Manual is not applicable to the implementation of MR #6 in Kitsap County except for rural (outside the UA and UGA) residential project sites that are 5 acres or greater. If a TDA meets either of the following thresholds for a rural residential project site, runoff treatment BMPs are required:~~

- ~~TDAs that have a total of 5,000 square feet or more of PGHS, or~~
- ~~TDAs that have a total of 3/4 of an acre or more of PGPS – not including permeable pavements, and from which there will be a surface discharge in a natural or manmade conveyance system from the site.~~

~~The project proponent must demonstrate that the TDA does not meet either of these thresholds for runoff treatment BMPs to not be required for that TDA. Refer to Volume I, Section I-3.4.6 of the Ecology Manual for details.~~

4.2.6.2 Runoff Treatment Facility Sizing

Size ~~runoff treatment BMPs~~ **stormwater treatment facilities** for the entire area that drains to them, even if some of those areas are not pollution-generating, or were not included in the project site threshold decisions (~~see Volume I, Section 4.1 of this chapter~~) ~~or the treatment threshold decisions of this minimum requirement.~~ ~~Runoff treatment BMPs are sized by using either a volume (Water Quality Design Storm Volume) or a flow rate (Water Quality Design Flow Rate), depending on the runoff treatment BMP selected.~~

4.2.6.3 Water Quality Design Storm Volume:

When using an approved continuous runoff model, the water quality design storm volume shall be equal to the simulated daily volume that represents the upper limit of the range of daily volumes that accounts for 91% of the entire runoff volume over a multi-decade period of record.

4.2.6.4 Water Quality Design Flow Rate:

The water quality design flow rate is dependent on the location of the runoff treatment BMP relative to the detention BMP(s):

- **Upstream of Preceding Detention BMPs/Facilities or when there are no Detention BMPs/Facilities are not required:** The flow rate at or below which 91% of the runoff volume, as estimated by an approved continuous runoff model, will be treated. Design criteria for treatment facilities are assigned to achieve the applicable performance goal (e.g., 80% TSS removal) at the water quality design flow rate. At a minimum, 91% of the total runoff volume, as estimated by an approved continuous runoff model, must pass through the runoff treatment BMP(s)/facility(ies) at or below the approved hydraulic loading rate for the BMP(s)/facility(ies).
- **Downstream of Detention BMPs/Facilities:** The water quality design flow rate shall must be the full 2-year release rate from the detention BMP/facility.

4.2.6.4.2.6.5 Runoff Treatment Facility/BMP Selection, Design, and Maintenance

Stormwater treatment facilities/Runoff Treatment BMPs shall be:

- Selected in accordance with the process identified in Chapter 4 of Volume I, Chapter 4 of this manual and Chapter 2 of Volume V- Volume III, Chapter 1.2 of the Ecology Manual.
- Designed and maintained in accordance with the design and maintenance criteria in Volume V of the Ecology Manual.

4.2.6.5.4.2.6.6 Additional Requirements

The (Direct-direct or indirect) discharge of untreated stormwater from pollution-generating hard surfaces to ground water is prohibited, ~~except for the discharge achieved by infiltration or dispersion in accordance with runoff through use of On-site Stormwater Management/LID BMPs per the List Approach in Volume I, Section 4.2.5 does not violate this requirement, in accordance with Volume II, Chapter 5 of this manual and Chapter 5, Volume V and Chapter 7, Volume V of the Ecology Manual; or by infiltration through soils meeting the soil suitability criteria in Chapter 3 of Volume III of the Ecology Manual.~~

Oil control treatment is required for high-use sites, or those sites that typically generate high concentrations of oil due to high traffic turnover or the frequent transfer of oil. All stormwater from hard surfaces subject to motor vehicle traffic shall flow through a spill-containment type oil/water separator prior to surface discharge off site.

Kitsap Public Health District conducts regular lake sampling and has determined that Kitsap Lake and Long Lake are phosphorus limited. Therefore, Phosphorus treatment is required for project sites draining into these receiving water bodies.

4.2.6.64.2.6.7 Supplemental Guidelines

See Volume II, Section 5.3.4 for guidance on selection of runoff treatment BMPs. See Volume II, Chapter 5, and Volume V of the Ecology Manual for more-detailed guidance on selection, design, and maintenance of runoff treatment BMPs facilities. The water quality design storm volume and flow rates are intended to capture and effectively treat about 90-95% of the annual runoff volume in western Washington.

There are several levels of runoff treatment, depending on the type of land use activities. Volume V of the Ecology Manual includes performance goals for Basic, Enhanced, Phosphorus, and Oil Control treatment, and a menu of facility options for each treatment type. Treatment facilities that are selected from the appropriate menu and designed in accordance with their design criteria are presumed to meet the applicable performance goals.

Kitsap Public Health District conducts regular lake sampling and has determined that Kitsap Lake and Long Lake are phosphorus limited. Therefore, Phosphorus treatment is required for project sites draining into these receiving water bodies.

An adopted and implemented basin plan or a TMDL (also known as a Water Clean-up Plan) may be used to develop runoff treatment requirements that are tailored to a specific basin. However, runoff treatment requirements shall not be less than that achieved by facilities inmeet, at a minimum, the Basic Treatment MenuPerformance Goal (see Volume I of the Ecology Manual). See Volume V, Chapter 3 of the Ecology Manual.

Runoff from surfaces that are not pollution-generating do not need to be treated and may bypass the Runoff Treatment BMP(s), if it is not mingled with runoff from pollution-generating surfaces.

Do not mix drainage from areas in native vegetation with untreated runoff from streets and driveways, if possible. It is best to infiltrate or disperse this relatively clean runoff to maximize recharge to shallow ground water, wetlands, and streams.

Treatment facilities applied consistent with this manual are presumed to meet the requirement of state law to provide all known available and reasonable methods of treatment (RCW 90.52.040, RCW 90.48.010). This technology-based treatment requirement does not excuse any discharge from the obligation to apply whatever technology is necessary to comply with state water quality standards, Chapter 173-201A WAC; state ground water quality standards, Chapter 173-200 WAC; state sediment management standards, Chapter 173-204 WAC; and the underground injection control program, Chapter 173-218 WAC. Additional treatment to meet those standards may be required.

Infiltration through use of On-site Stormwater Management BMPs can provide both treatment of stormwater, through the ability of certain soils to remove pollutants, and volume control of stormwater, by decreasing the amount of water that runs off to surface water. Infiltration through engineered treatment facilities that utilize the natural soil profile can also be very effective at treating stormwater runoff, but pretreatment must be applied and soil conditions must be

~~appropriate to achieve effective treatment while not impacting ground water resources. See Volume II, Chapter 5 of this manual and Chapter 6 of Volume V of the Ecology Manual for pretreatment design details.~~

~~Discharge of pollution-generating surfaces into a dry well, after pretreatment for solids reduction, can be acceptable if the soil conditions provide sufficient treatment capacity. Dry wells into gravelly soils are not likely to have sufficient treatment capability. They must be preceded by at least a Basic Treatment BMP. See Volume II, Chapter 5 of this manual and Volume V, Chapters 2 and 7 of the Ecology Manual for details.~~

~~Impervious surfaces that are “fully dispersed” in accordance with BMP T5.30 in Volume V of the Ecology Manual are not considered effective impervious surfaces. Impervious surfaces that are “dispersed” in accordance with BMPs T5.10B, T5.11, and T5.12 in Section 5.3.1 of Volume V of the Ecology Manual are still considered effective surfaces though they may be modeled as pervious surfaces if flow path lengths meet the specified minima. See Volume III, Appendix III-C of the Ecology Manual for a more complete description of hydrologic representation of On-site Stormwater Management BMPs.~~

4.2.7 Minimum Requirement #7: Flow Control

Projects must provide flow control to reduce the impacts of stormwater runoff from hard surfaces and land cover conversions. ~~The standard flow control requirements below apply to projects that discharge stormwater directly, or indirectly through a conveyance system, into a fresh waterbody.~~

If the discharge is to a stream that leads to a wetland, or to a wetland that has an outflow to a stream, both this requirement and Minimum Requirement #8 – Wetlands Protection apply.

4.2.7.1 Exemptions

Flow control is not required for projects that discharge ~~directly to or indirectly through an MS4 to a water listed in Appendix I-A of the Ecology Manual, Puget Sound,~~ subject to all of the following restrictions:

- Direct discharge to the exempt receiving water does not result in the diversion of drainage from any perennial stream classified as Types 1, 2, 3, or 4 in the State of Washington Interim Water Typing System ([WAC 222-16-031](#)), or Types “S,” “F,” or “Np” in the Permanent Water Typing System ([WAC 222-16-030](#)), or from any Category I, II, or III wetland; ~~and~~
- ~~If f~~Flow splitters~~ing devices~~ or ~~conveyance elements~~drainage BMPs are applied to route natural runoff volumes from the project site to any downstream Type 5 stream or Category IV wetland, then:
 - Design of the flow splitters~~ing devices~~ or ~~conveyance elements~~drainage BMPs ~~shall will~~ be based on approved continuous ~~simulation~~hydrologic modeling analysis. The design ~~shall will~~ ensure that flows delivered to Type 5 stream reaches will approximate, but in no case exceed, durations ranging from 50% of the 2-year to the 50-year peak flow.

- Flow splitters or conveyance elements that deliver flow to Category IV wetlands shall also be designed using approved continuous simulation hydrologic modeling to preserve pre-project wetland hydrologic conditions unless specifically waived or exempted by regulatory agencies with permitting jurisdiction; and
- The project site must be drained by a conveyance system that is comprised entirely of manmade conveyance elements (e.g., pipes, ditches, outfall protection) and extends to the ordinary high water line of the exempt receiving water; and
- The conveyance system between the project site and the exempt receiving water shall have sufficient hydraulic capacity to convey discharges from future build-out conditions (under current zoning) of the site, and the existing condition from non-project areas from which runoff is or will be collected; and
- Any erodible elements of the manmade conveyance system must be adequately stabilized to prevent erosion under the conditions noted above.

4.2.7.2 **Thresholds**

The following projects require achievement of the standard flow control requirement:

- Projects in which the total of effective impervious surfaces is 10,000 square feet or more in a threshold discharge area, or
- Projects that convert 3/4 acre or more of vegetation to lawn or landscape, or convert 2.5 acres or more of native vegetation to pasture in a threshold discharge area, and from which there is a surface discharge in a natural or manmade conveyance system from the site, or
- Projects that through a combination of effective hard surfaces and converted vegetation areas cause a 0.150-10 cubic feet per second (cfs) increase in the 100-year flow frequency from a threshold discharge area as estimated using the WWHM or other approved continuous simulation model and 15-minute one-hour time steps (or a 0.15 cfs increase using 15-minute time steps).²

When assessing a project against the above thresholds, consider only those surfaces that are subject to this minimum requirement as determined in [Volume 1, Section 4.1 of this Chapter](#).

Note: The use of TDAs detailed in the Ecology Manual is not applicable to the implementation of MR #7 in Kitsap County except for rural (outside the UA and UGA) residential project sites that are 5 acres or greater. If a TDA meets any of the following thresholds for a rural residential project site, flow control BMPs are required:

² For the purpose of applying this threshold, the existing condition is either the pre-project land cover, (for a developed site with an approved stormwater mitigation plan) or the land cover that existed at the site as of a date when the County first adopted flow control requirements into code or rules (September 21, 1987).

- TDAs that have a total of 10,000 square feet or more of effective impervious surfaces, or
- TDAs that convert 3/4 acre or more of vegetation to lawn or landscape, or convert 2.5 acres or more of native vegetation to pasture, and from which there is a surface discharge in a natural or manmade conveyance system from the TDA, or
- TDAs that through a combination of effective hard surfaces and converted vegetation areas cause a 0.15 cfs increase in the 100-year flow frequency as estimated using WWHM or other approved continuous simulation model and 15-minute time steps

Refer to Volume I, Section I-3.4.7 in the Ecology Manual for details.

4.2.7.3 Standard Flow Control Performance Standard Requirements

Stormwater discharges shall match developed discharge durations to pre-developed durations for the range of pre-developed discharge rates from 50% of the 2-year peak flow up to the full 50-year peak flow. The pre-developed condition to be matched shall be a forested land cover unless reasonable, historical information is provided that indicates the site was prairie prior to settlement (modeled as “pasture” in the [WWHM approved continuous simulation model](#)).

4.2.7.4 Additional Requirement

Flow Control BMPs shall be selected, designed, and maintained [in accordance with](#) Volume II [of this manual](#).

4.2.7.5 Supplemental Guidelines

Reduction of flows through infiltration decreases stream channel erosion and helps to maintain base flow throughout the summer months. [However, infiltration shall follow the guidance in this manual to reduce the chance that of threatening ground water quality is threatened by such discharges.](#)

[Volume III of the Ecology Manual includes a description of the WWHM. The model provides ways to represent On-site Stormwater Management BMPs described in Volumes III and V of the Ecology Manual. Using these LID BMPs reduces the predicted runoff rates and volumes, and thus also reduces the size of the required flow control Control facilities BMPs.](#)

Application of [sufficient types of On-site Stormwater Management certain LID and/or infiltration BMPs](#) can result in reducing the effective impervious area and the converted vegetation areas such that a [flow control facility Flow Control BMP](#) is not required. [See the definition of Effective Impervious Surface for details.](#) Application of “Full Dispersion”, [BMP T5.30: Full Dispersion in Volume V of the Ecology Manual](#), also results in eliminating the [flow control facility](#) requirement for [a Flow Control BMP for](#) those areas that are “fully dispersed.” [See the guidelines in Volume I, Appendix 1-D of the Ecology Manual for Minimum Requirement #8, and directions concerning use of the Western Washington Hydrology Model for information about the approach for protecting wetland hydrologic conditions.](#)

4.2.8 Minimum Requirement #8: Wetlands Protection

Wetlands are extremely important natural resources that provide multiple stormwater benefits, including ground water recharge, flood control, and stream channel erosion protection. They are easily impacted by development unless careful planning and management are conducted. Wetlands can be severely degraded by stormwater discharges from urban development due to pollutants in the runoff and also due to disruption of natural hydrologic functioning of the wetland system. Changes in water levels and the frequency and duration of inundations are of particular concern.

4.2.8.1 Applicability

The requirements below apply only to projects whose stormwater discharges into a wetland, either directly or indirectly through a conveyance system.

4.2.8.2 Thresholds

The thresholds identified in Minimum Requirement #6 – Runoff Treatment and Minimum Requirement #7 – Flow Control shall also be applied to determine the applicability of this requirement to discharges to wetlands.

[The use of TDAs detailed in the Ecology Manual is not applicable to the implementation of MR #8 in Kitsap County](#) ~~except for rural (outside the UA and UGA) residential project sites that are 5 acres or greater. Refer to Volume I, Section I-3.4.8 of the Ecology Manual for details.~~

4.2.8.3 Standard Requirement

Projects shall comply with ~~Guide Sheets #1 through #3 in Volume I, Appendix 1-D of the Ecology Manual~~ [Volume I, Appendix I-C of the Ecology Manual](#). The hydrologic analysis shall use the existing land cover condition to determine the existing hydrologic conditions unless directed otherwise [in the Critical Areas Ordinance codified as Title 19 KCC by the County](#).

4.2.8.4 Additional Requirements

~~Runoff/Stormwater~~ treatment and flow control ~~BMPs/facilities~~ shall not be built within a natural vegetated buffer, except for:

- Necessary conveyance systems as approved by the County; or
- As allowed [for compensatory mitigation in Volume I, Appendix I-C, Section C.6 of the Ecology Manual](#). ~~in wetlands approved for hydrologic modification and/or treatment in accordance with Guide Sheet 2 in Appendix I-D of Volume I of the Ecology Manual.~~

4.2.8.5 Supplemental Guidelines

[Volume I, Appendix I-C of the Ecology Manual](#) shall be used for discharges to natural wetlands and ~~mitigated wetlands constructed as mitigation~~. [Refer to KCC 19.200.220 for fencing and planting requirements for wetland buffers](#). ~~While it is always necessary to pre-treat stormwater prior to discharge to a wetland, there are limited circumstances where wetlands may be used for additional treatment and detention of stormwater. These situations are considered in Guide Sheet 2 of Appendix 1-D of the Ecology Manual.~~

~~Note that if selective runoff bypass is an alternative being considered to maintain the hydroperiod, the hydrologic analysis must consider the impacts of the bypassed flow. For instance, if the bypassed flow is eventually directed to a stream, the flow duration standard, Minimum Requirement #7—Flow Control, applies to the bypass.~~

4.2.9 Minimum Requirement #9: Operation and Maintenance

An operation and maintenance manual that is consistent with the provisions in Volume II, Chapter 7 ~~of this manual~~ shall be provided for proposed [runoff treatment and flow control stormwater facilities and BMPs](#), and ~~T~~the party (or parties) responsible for maintenance and operation shall be identified [in the operation and maintenance manual](#). At private facilities, a copy of the operation and maintenance manual shall be retained on site or within reasonable access to the ~~site, and~~[site and](#) shall be transferred with the property to the new owner. For public facilities, a copy of the operation and maintenance manual shall be retained in the appropriate department. A log of maintenance activity that indicates what actions were taken shall be kept and be available for inspection by the County.

Maintenance requirements for individual BMPs are also provided in Volume II, Chapter 5 ~~of this manual. Volumes II, III, and V of the Ecology Manual~~[Volumes II, III, and V of the Ecology Manual](#) include sections on maintenance. [Volume V, Appendix V-A of the Ecology Manual](#) includes a schedule of maintenance standards for [runoff treatment and flow control BMPs](#)~~drainage facilities~~.

Kitsap County Stormwater Design Manual

Volume II – Design Standards and Requirements

3rd Draft
April 2021

2021 3rd Draft Revisions are highlighted in aqua and green

This page intentionally left blank.

CONTENTS

CHAPTER 1	PLANS AND REPORTS	1-1
1.1	Introduction	1-1
1.2	Drainage Review.....	1-1
1.2.1	Projects Requiring Drainage Review.....	1-1
1.2.2	Review Types and Requirements	1-2
1.2.3	Review Stages	1-4
1.2.4	Drainage Review Required by Other Agencies	1-6
1.2.5	Drainage Design Beyond Minimum Requirements.....	1-6
1.3	Submittal Processes and Requirements	1-7
1.4	Submittal Documents	1-9
1.4.1	Site Assessment and Planning Packet.....	1-9
1.4.2	Site Improvement Plans	1-9
1.4.3	Construction Stormwater Pollution Prevention Plan.....	1-18
1.4.4	Drainage Reports	1-21
1.4.5	Geotechnical Analysis/Soils Reports.....	1-24
1.4.6	Single Family Residential Subdivision Design Submittals.....	1-26
1.4.7	Other Reports.....	1-27
1.5	Permit Issuance	1-27
1.5.1	Pre-construction Meeting	1-28
1.5.2	Final Project Approval	1-28
1.5.3	Performance Bond for uncompleted Subdivision improvements.....	1-30
1.5.4	Transfer of Engineering Responsibilities	1-30
1.5.5	Project Phasing	1-30
1.5.6	Permit Extensions and Renewals.....	1-31
CHAPTER 2	CONSTRUCTION STORMWATER POLLUTION PREVENTION	2-1
2.1	Introduction	2-1
2.2	Construction Stormwater BMPs	2-1
CHAPTER 3	SOURCE CONTROL OF POLLUTION	3-1
3.1	Introduction	3-1
3.2	Project Submittal Requirements.....	3-1
3.3	Operation and Structural Source Control BMPs	3-1
3.4	Selection of Operational and Structural Source Control BMPs.....	3-2

3.4.1	When are Source Control BMPs Required?.....	3-2
3.4.2	How to Determine Which Source Control BMPs are Appropriate for the Site	3-3
3.5	Local Amendments to Operational and Structural Source Control BMPs	3-4
3.5.1	S427: BMPs for Storage of Liquid, Food Waste, or Dangerous Waste Containers	3-5
3.5.2	S429: BMPs for Storage or Transfer (Outside) of Solid Raw Materials, Byproducts, or Finished Products	3-8
3.5.3	S431: BMPs for Washing and Steam Cleaning Vehicles/Equipment/ Building Structures.....	3-11
3.5.4	S449: BMPs for Nurseries and Greenhouses	3-14
CHAPTER 4	CONVEYANCE SYSTEM ANALYSIS & DESIGN	4-1
4.1	Introduction	4-1
4.2	Conveyance System Design Flow	4-1
4.2.1	Rational Method	4-1
4.2.2	Santa Barbara Urban Hydrograph Method.....	4-2
4.2.3	Western Washington Hydrology Model (WWHM)	4-2
4.2.4	MGSFlood	4-2
4.3	Route Design and Easement Requirements.....	4-2
4.3.1	Route Design.....	4-2
4.3.2	Discharge Type and Location.....	4-3
4.3.3	Easement and Setback Requirements.....	4-3
4.4	Pipes, Outfalls, and Pumps.....	4-4
4.4.1	Pipe Systems	4-5
4.4.2	Outfall Systems	4-11
4.4.3	Pump Systems	4-13
4.5	Culverts.....	4-13
4.5.1	Design Criteria.....	4-14
4.5.2	Methods of Analysis	4-16
4.6	Open Channels	4-17
4.6.1	Natural Channels.....	4-17
4.6.2	Constructed Channels.....	4-17
4.6.3	Design Criteria.....	4-18
4.6.4	Methods of Analysis	4-20
4.7	Downstream Analysis.....	4-20
4.7.1	Level 1 Analysis	4-21
4.7.2	Level 2 Analysis	4-22

4.7.3	Level 3 Analysis	4-22
4.8	Hydraulic Structures	4-23
4.8.1	Flow Splitters	4-23
4.8.2	Flow Spreaders	4-24
CHAPTER 5	STORMWATER MANAGEMENT BMPS	5-1
5.1	Purpose of This Chapter	5-1
5.2	Organization of This Chapter	5-1
5.3	BMP Selection.....	5-2
5.3.1	Determine Dispersion Feasibility	5-3
5.3.2	Determine Infiltration Feasibility	5-7
5.3.3	Select BMPs for On-site Stormwater Management.....	5-3
5.3.4	Select BMPs for Runoff Treatment.....	5-4
5.3.5	Select BMPs for Flow Control	5-11
5.4	BMP Design	5-11
5.4.1	Post Construction Soil Quality and Depth	5-13
5.4.2	Better Site Design	5-16
5.4.3	Preserving Native Vegetation	5-17
5.4.4	Dispersion BMPs	5-18
5.4.5	Rain Gardens	5-23
5.4.6	Bioretention Cells, Swales, and Planter Boxes	5-25
5.4.7	Perforated Stub-out Connections	5-30
5.4.8	Permeable Pavement.....	5-32
5.4.9	Tree Retention and Tree Planting	5-37
5.4.10	Vegetated Roofs.....	5-38
5.4.11	Reverse Slope Sidewalks.....	5-42
5.4.12	Minimal Excavation Foundations.....	5-43
5.4.13	Rainwater Harvesting	5-44
5.4.14	Pre-settling Basins	5-46
5.4.15	Infiltration Basins	5-48
5.4.16	Infiltration Trenches.....	5-50
5.4.17	Drywells.....	5-52
5.4.18	Compost-amended Vegetated Filter Strips (CAVFS).....	5-55
5.4.19	Sand Filters	5-56
5.4.20	Media Filter Drains	5-60
5.4.21	Vegetated Filter Strips	5-63

5.4.22	Wetponds	5-64
5.4.23	Wetvaults.....	5-67
5.4.24	Stormwater Treatment Wetlands.....	5-69
5.4.25	Oil/Water Separators	5-72
5.4.26	Detention Ponds	5-75
5.4.27	Detention Tanks	5-77
5.4.28	Detention Vaults	5-79
5.4.29	Combined Detention and Wetpool Facilities.....	5-80
5.4.30	Manufactured Treatment Devices as BMPs	5-83
CHAPTER 6	WETLANDS PROTECTION	6-1
6.1	Introduction	6-1
6.2	Applicability	6-1
6.3	Thresholds	6-1
6.4	Standard Requirement	6-1
6.5	Coordination with Minimum Requirement #7	6-1
CHAPTER 7	OPERATION AND MAINTENANCE	7-1
7.1	Introduction	7-1
7.2	Operation and Maintenance Requirements	7-1
7.2.1	Responsibility for Maintenance.....	7-1
7.2.2	Maintenance Activities and Frequencies.....	7-1
7.2.3	Disposal of Waste from Maintenance Activities.....	7-2
7.2.4	Maintenance of Plat BMPs During Home Building	7-2
7.3	Operation and Maintenance Manual	7-2
CHAPTER 8	CRITICAL DRAINAGE AREAS	8-1
8.1	Introduction	8-1
8.2	Identification of Critical Drainage Areas	8-1
8.2.1	Areas with Specific Site Physical Attributes	8-1
8.2.2	Areas Defined for Protection of Fish & Wildlife Habitat and Surface Water Quality	8-2
8.2.3	Areas Designated as Having Documented and/or Potential Drainage Issues ...	8-2
8.3	Supplemental Requirements.....	8-3
8.3.1	Closed Depressions	8-3
8.3.2	Steep Slopes and Geologically Hazardous Areas.....	8-4
8.3.3	Aquifer Recharge Areas	8-4
8.3.4	Wetlands and Streams	8-5

8.3.5	Shorelines	8-5
CHAPTER 9	GRADING	9-1
9.1	Introduction	9-1
9.2	Review Coordination	9-1
9.3	Permit Requirements	9-1
9.3.1	Construction Limits	9-1
9.3.2	Engineers' Notification Of Noncompliance	9-2
9.3.3	Inspections	9-2
9.3.4	Completion of Work and Final Approval	9-2
9.4	Grading Standards	9-2
9.4.1	Geotechnical Report.....	9-3
9.4.2	Excavations	9-3
9.4.3	Fills and Embankments	9-3
9.4.4	Setbacks.....	9-4
9.4.5	Drainage and Terracing.....	9-5
9.4.6	Erosion Control.....	9-6

LIST OF FIGURES

Figure 1-1.	Flow Chart for Determining Type of Drainage Review Required.....	1-3
Figure 3-1.	Example of a covered, bermed, and plumbed area – plan view.....	3-6
Figure 3-2.	Example of a covered, bermed, and plumbed area – side view	3-6
Figure 4-1.	Dispersion Trench.	4-3
Figure 4-2.	Alternative Dispersion Trench.	4-3
Figure 4-3.	Through-Curb Inlet	4-8
Figure 4-4.	Pipe Anchor Detail.....	4-10
Figure 4-5.	Corrugated Metal Pipe Coupling and/or General Pipe Anchor Assembly	4-10
Figure 4-6.	Debris Barrier	4-10
Figure 4-7.	Gabion Mattress Dissipater Detail	4-12
Figure 4-8.	Tee Type Energy Dissipater	4-13
Figure 4-9.	Pipe Culvert Discharge Protection.....	4-15
Figure 4-10.	Concrete End Protection	4-15
Figure 4-11.	Ditches – Common Sections	4-19
Figure 4-12.	Drainage Ditches – Common Sections.....	4-19
Figure 4-13.	Geometric Elements of Common Sections.....	4-19
Figure 4-14.	Flow Splitter, Option A.....	4-23
Figure 4-15.	Flow Splitter, Option B.....	4-23
Figure 4-16.	Flow Spreader Option A: Anchored Plate.....	4-25
Figure 4-17.	Flow Spreader Option B: Concrete Sump Box	4-26
Figure 4-18.	Flow Spreader Option C: Notched Curb Spreader	4-26
Figure 4-19.	Flow Spreader Option D: Through-Curb Port	4-26
Figure 5-1.	Infiltration Feasibility Flow Chart.....	5-8
Figure 5-2.	Treatment BMP Selection Flow Chart	5-5

Figure 8-1. Critical Drainage Areas Commissioner District 1	8-3
Figure 8-2. Critical Drainage Areas Commissioner District 2	8-3
Figure 8-3. Critical Drainage Areas Commissioner District 3	8-3

LIST OF TABLES

Table 1-1. Drainage Requirements that Must Be Evaluated for Each Type of Drainage Review 1-4	
Table 1-2. Example Permits or Approvals that May Be Required by Other Agencies	1-6
Table 1-3. Summary of Submittal Requirements for Each Review Stage and Type of Drainage Review	1-8
Table 4-1. Allowable Structures and Pipe Sizes	4-7
Table 4-2. Maximum Cover (feet) for Concrete Pipe-Compaction Design A	4-9
Table 4-3. Maximum Pipe Slopes and Velocities	4-10
Table 4-4. Rock Protection at Outfalls	4-15
Table 4-5. Channel Protection	4-19
Table 5-1. Summary of Minimum Dispersion Flow Path Area and Length Requirements	5-3
Table 5-2. Minimum Horizontal Setback Requirements between Stormwater BMPs and On-site Sewage System (OSS) Components	5-6
Table 5-3. Summary of Minimum Investigation and Testing Requirements for Shallow Infiltration BMPs, Steps 2, 3, and 5 ^a	5-3
Table 5-4. Minimum Measured Infiltration Rates	5-1
Table 5-5. Post Construction Soil Quality and Depth Applicability	5-13
Table 5-6. Preserving Native Vegetation Applicability	5-17
Table 5-7. Dispersion Applicability	5-21
Table 5-8. Rain Gardens Applicability	5-24
Table 5-9. Bioretention Cells, Swales, and Planter Boxes Applicability	5-27
Table 5-10. Perforated Stub-out Connection Applicability	5-31
Table 5-11. Permeable Pavement Applicability ^a	5-34
Table 5-12. Tree Retention and Tree Planting Applicability	5-38
Table 5-13. Vegetated Roofs Applicability	5-39
Table 5-14. Reverse Slope Sidewalks Applicability	5-42
Table 5-15. Minimal Excavation Foundation Applicability	5-44
Table 5-16. Rainwater Harvesting Applicability	5-45
Table 5-17. Infiltration Basins Applicability ^a	5-48
Table 5-18. Infiltration Trenches Applicability ^a	5-50
Table 5-19. Drywell Applicability	5-52
Table 5-20. CAVFS Applicability	5-56
Table 5-21. Sand Filter BMPs Applicability	5-58
Table 5-22. MFD Applicability	5-61
Table 5-23. Basic Filter Strip Applicability	5-63
Table 5-24. Wetpond Applicability	5-65
Table 5-25. Wetvault Applicability	5-68
Table 5-26. Stormwater Treatment Wetland Applicability	5-70
Table 5-27. Oil/Water Separator Applicability	5-73
Table 5-28. Detention Pond Applicability	5-75
Table 5-29. Detention Tank Applicability	5-77
Table 5-30. Detention Vault Applicability	5-79
Table 5-31. Combined Detention and Wetpool BMP Applicability	5-82

CHAPTER 1 PLANS AND REPORTS

1.1 Introduction

This chapter details the requirements for drainage-related plans and reports that must be submitted with a permit application to the Kitsap County Department of Community Development (DCD), in accordance with [Section 2.5.1 of Volume I of the Ecology Manual](#)~~Volume I, Section 3.4.1 of the Ecology Manual~~ (Minimum Requirement #1 – Preparation of Stormwater Site Plans) and Kitsap County Code ([KCC](#)) [Section 21.04.160](#).

Most projects require some degree of drainage planning and/or analysis to be submitted with the initial permit application. Site plans provide information on the proposal, including, but not limited to, location of critical areas, road alignments and ~~right-of-way~~[right of way](#), site topography, building locations, land use information, and lot dimensions. They are used to determine the appropriate drainage conditions and requirements to be applied to the project during the drainage review process. The intent of these requirements is to clearly identify for applicants the format and technical support data necessary for the development of consistent and complete design plans.

The remainder of this chapter describes the various drainage review types that may apply to a project based on development type, size, location, and potential on-site or downstream impacts; how to submit drainage plans and reports based on the applicable drainage review type; and the process for permit issuance. The required submittal contents and formats are described in detail herein. The drainage requirements that these plan and report submittals shall address are contained in [Title 12 KCC](#). The specific design methods and criteria to be used are contained in Volume II, Chapters 2 through 9 ~~of this manual~~.

1.2 Drainage Review

Drainage review is the evaluation by Kitsap County staff of a proposed project's compliance with the drainage requirements in this manual. The Kitsap County department responsible for drainage review is DCD, unless otherwise specified in [KCC Section 21.04.100](#).

This section describes the permits that require a drainage review, the various types of drainage review that may apply depending upon the project and site conditions, drainage requirements that may be imposed by other agencies, and additional requirements that may apply beyond the minimum stormwater requirements defined in Volume I ~~of this manual~~.

1.2.1 Projects Requiring Drainage Review

Drainage review is required for any land use permit and approval, as defined in [Chapter 12.08 KCC](#), and for all Site Development Activity Permits (SDAP). SDAP drainage review shall be required as set forth in [KCC Section 12.10.030](#). See [Volume II](#), Section 1.3 ~~below~~ for submittal processes and requirements. For projects that require a building permit or other land use review but do not trigger an SDAP, drainage review shall be required as set forth in [KCC Section 12.20.010](#).

1.2.2 Review Types and Requirements

For most projects resulting in 2,000 square feet or more of new plus replaced hard surface area or 7,000 square feet or more of land disturbing activity, the full range of minimum requirements contained in Volume I [of this manual](#) shall be evaluated for compliance through the drainage review process. However, for some types of projects, the scope of requirements applied is targeted to allow more efficient, customized review.

The review process and drainage requirements vary based on a project's size, location, type of development, and anticipated impacts to the local and regional surface water system. There are five types of drainage review, as follows:

1. Simplified Drainage Review
2. Simplified Drainage Review - Engineered
3. Abbreviated Drainage Review
4. Abbreviated Drainage Review - Engineered
5. Full Drainage Review

The permit or conditions that trigger each type of drainage review are described in [the sections Volume II, Sections 1.2.2.1, 1.2.2.2, 1.2.2.3, 1.2.2.4, and 1.2.2.5](#) below. Figure 1.1 provides a flow chart for determining which type of drainage review is required. Table 1.1 summarizes the requirements that must be evaluated based on the applicable type of review, while [Volume II](#), Sections 1.3 and 1.4 outline the specific materials (i.e., plans, analyses, reports, and other documents) that must be submitted at various stages of permit review.

1.2.2.1 Simplified Drainage Review

Simplified Drainage Review applies to small ([Chapter 12.08 KCC](#)) Single Family Residential (SFR) projects for which Minimum Requirements #1 through #5 apply, located outside of critical areas and their buffers [and that do not implement a Threshold Discharge Area \(TDA\) approach \(Volume I, Section 3\)](#). This type of drainage review is triggered by a building permit. The review process is streamlined by not requiring Preliminary Design Review ([Volume II](#), Section 1.2.3.1) and allowing for targeted submittal documents that do not require a professional engineer, as detailed in [Volume II](#), Section 1.4.2.3(a).

1.2.2.2 Simplified Drainage Review - Engineered

Simplified Drainage Review – Engineered applies to small ([Chapter 12.08 KCC](#)) SFR projects located inside critical areas ([see KCC 12.28.020](#)) or their buffers [and to small \(Chapter 12.08 KCC\) SFR projects that implement a TDA approach \(Volume I, Section 3\)](#). As with Simplified Drainage Review, this type of drainage review is triggered by a building permit, not by an SDAP. Preliminary Design Review ([Volume II](#), Section 1.2.3.1) is not required. Submittals must be prepared by a professional engineer. Additional mitigation beyond the minimum stormwater requirements in Volume I [of this manual](#) may be required to compensate for loss of critical drainage area habitat functions associated with activities inside the critical drainage area or

critical drainage area buffers. See [Volume II](#), Section 1.4.2.3(b) for detailed submittal requirements for this type of drainage review.

1.2.2.3 Abbreviated Drainage Review

Abbreviated Drainage Review applies to the following project types:

- Small ([Chapter 12.08 KCC](#)) non-SFR projects for which Minimum Requirements #1 through #5 apply, located outside critical areas and their buffers; and
- Grading only projects located outside critical areas and their buffers that involve the movement of between 150 and 5,000 cubic yards of material.

This type of drainage review is triggered by an SDAP. Preliminary Design Review ([Volume II](#), Section 1.2.3.1) is required, but the submittal process is streamlined by allowing targeted submittal documents that do not require a professional engineer, as detailed in [Volume II](#), Section 1.4.2.3(c).

1.2.2.4 Abbreviated Drainage Review - Engineered

Abbreviated Drainage Review - Engineered applies to the following project types:

- Small ([Chapter 12.08 KCC](#)) non-SFR projects for which Minimum Requirements #1 through #5 apply and grading only projects that involve the movement of between 150 and 5,000 cubic yards of material [that where the project](#):
 - Connects into a drainage system in the [right-of-wayright of way](#); or
 - Constructs improvements in the [right-of-wayright of way](#); or
 - Constructs in a critical area or critical area buffer.

This type of drainage review is triggered by an SDAP and requires a professional engineer. See [Volume II](#), Section 1.4.2.3(d) for detailed submittal requirements.

1.2.2.5 Full Drainage Review

Full Drainage Review - Engineered applies to large ([Chapter 12.08 KCC](#)) projects for which Minimum Requirements #1 through #9 apply. This type of drainage review is triggered by an SDAP. See [Volume II](#), Section 1.4.2.3(e) for detailed submittal requirements.

[\(See separate file for Public Review Draft figures\)](#)

Figure 1.1.—Flow Chart for Determining Type of Drainage Review Required

Table 1.1. Drainage Requirements that Must Be Evaluated for Each Type of Drainage Review

Drainage Review Type	Minimum Requirements #1-5 ^a	Minimum Requirements #1-9 ^a	Critical Drainage Area Requirements ^b	Special Requirements ^b
Simplified Drainage Review	✓			
Simplified Drainage Review – Engineered	✓		✓	
Abbreviated Drainage Review	✓			
Abbreviated Drainage Review - Engineered	✓		✓	✓
Full Drainage Review		✓	✓	✓

Notes:

^a See Volume [I4, Section 4.2](#) for discussion of minimum requirements.

^b See [Volume II](#), Sections 1.2.4 and 1.2.5.

1.2.3 Review Stages

This section defines [three](#) stages of drainage review, including Site Assessment and Planning Review, Preliminary Design Review, and Final Design Review. Not all stages of drainage review are required for all projects. The applicability of each review stage based on the drainage review type and the basic requirements for each review stage are described below. Table 1.3 [in Volume II, Section 1.3](#) summarizes the plan and report submittals required for each stage of review.

1.1.1.1 Site Assessment and Planning Review

For all drainage review types, this review stage entails completing permit applications and conducting a site assessment and planning study to evaluate and document the early consideration of project and site components that affect design. Volume I, Section 2.5 [of this manual](#) outlines the requirements for site assessment and planning and [Volume II](#), Section 1.4.1 details the associated submittal document required.

1.2.3.1 Preliminary Design Review

Preliminary design review is required for any proposed project that requires a land use permit or approval. The purpose of this review stage is to demonstrate that the project is feasible and can meet the applicable standards and requirements. All preliminary submittal documents shall be at 60-percent level of design, or higher.

All land boundary surveys and legal descriptions used for preliminary design review shall be stamped by a land surveyor licensed in the State of Washington. Topographic survey data and mapping prepared specifically for a proposed project may be performed by the professional engineer stamping the engineering plans as allowed by the Washington State Board of Registration for Professional Engineers and Land Surveyors.

**Example Project Types
Subject to Preliminary
Design Review:**

- Subdivisions
- Short Subdivisions
- Large Lot Subdivisions
- Performance Based Developments
- Conditional Use Permits

The plan set shall follow the requirements of site improvement plans ([Volume II](#), Section 1.4.2) and shall contain the base map, the basic site plan requirements, plus the following:

1. Professional engineer's seal, signed and dated.
2. Professional land surveyor's seal, signed and dated, where applicable.
3. Contour lines, at maximum 5-foot intervals, with source of datum identified.
4. If connecting to Kitsap County Sanitary Sewer, see Kitsap County Public Works (KCPW) Standards for Sanitary Sewer Extensions additional site plan requirements.
5. Approximate plan for the collection and conveyance of stormwater through the project site. At a minimum, show with flow arrows the directions of proposed stormwater runoff and indicate the method for conveyance (e.g., pipe, ditch, bioretention filter, overland flow, etc.).
6. Proposed locations and sizes of stormwater Best Management Practices (BMPs), including typical cross-sections for On-site Stormwater Management, Flow Control, and Water Quality Treatment facilities. Refer to [Chapter 5 of Volume II](#), [Chapter 5 of this manual](#) for stormwater BMP design requirements.
7. For any proposal that includes public or private roadway construction or improvement, including but not limited to subdivisions, short subdivisions, large lot subdivisions and performance-based developments, provide road plan and profiles in accordance with Kitsap County Road Standards, Title 11 KCC, showing existing grade and approximate finished grade. Private roads may not have to be built to the same standard as public roads, but the plans shall contain all the same elements.

1.2.3.2 Final Design Review

The objective of the final stormwater design review is to demonstrate that the project designs meet the applicable standards and requirements. All submittal documents in this review shall be at 90-percent level of design. For land use permit and approvals requiring only a simplified

drainage review, this final review will occur with the associated building permit for the land use permit or approval. For land use permit and approvals with any other drainage review, the final drainage review will occur with the associated or subsequently required SDAP.

The final design stage submittal shall follow the requirements of site improvement plans ([Volume II](#), Section 1.4.2) and shall contain the base map, the basic site plan requirements, plus the additional requirements listed for the preliminary design phase ([Volume II](#), Section 1.2.3.1).

1.2.4 Drainage Review Required by Other Agencies

Drainage review for a proposed project may be addressed by processes or requirements apart from Kitsap County’s [requirements](#). Agencies such as those listed in Table 1.2 may require some form of drainage review and impose drainage requirements that are separate from and in addition to Kitsap County’s drainage requirements. The applicant is responsible for coordinating with these agencies and resolving any conflicts in drainage requirements.

Table 1.2. Example Permits or Approvals that May Be Required by Other Agencies

Agency	Permit/Approval
Kitsap Public Health District	<ul style="list-style-type: none"> • Sewage Disposal Permit • and Well Permits
Washington State	
Department of Transportation	<ul style="list-style-type: none"> • Developer/Local Agency Agreement
Department of Fish and Wildlife	<ul style="list-style-type: none"> • Hydraulic Project Approval
Department of Ecology	<ul style="list-style-type: none"> • Short Term Water Quality Modification Approval • Dam Safety Permit • NPDES Stormwater Permit
Department of Natural Resources	<ul style="list-style-type: none"> • Forest Practices Class IV Permit
United States Army Corps of Engineers	<ul style="list-style-type: none"> • Sections 10 Permit • Section, 401 Permit, and • Section 404 Permits

1.2.5 Drainage Design Beyond Minimum Requirements

1.2.5.1 [Single Family Residential Subdivision Design](#)

[Single family residential subdivision lot development design shall also address the following requirements:](#)

- [For each lot, a minimum design assumption for hard surfaces and developed pervious surface shall be determined as part of the overall drainage design.](#)

- [The minimum design assumptions per lot shall be stated on the face of the SDAP plans and on the face of the final plat \(see Volume II, Section 1.4.6\).](#)
- [If surplus stormwater mitigation is provided for the subdivision to allow flexibility in individual lot design, that surplus availability shall be stated in square feet on the face of the final construction drawings and final plat. Usage of the surplus area by individual lot development may be considered when the design does not cause noncompliance with any conditions of subdivision approval or other applicable regulations.](#)

1.2.5.2 Additional Design Requirements

This manual presents Kitsap County’s minimum standards for engineering and design of drainage [BMPs](#)~~facilities~~. While Kitsap County believes these standards are appropriate for a wide range of project proposals, compliance solely with these requirements does not relieve the professional engineer submitting designs of ~~their~~[his or her](#) responsibility to ensure drainage facilities are engineered to provide adequate protection for natural resources and private property.

Compliance with the standards in this manual does not necessarily mitigate all probable and significant environmental impacts to aquatic biota. Fishery resources and other living components of aquatic systems are affected by a complex set of factors. While employing a specific flow control standard may prevent stream channel erosion or instability, other factors affecting fish and other biotic resources (e.g., increases in stream flow velocities) are not directly addressed by this manual. Likewise, some wetlands, including bogs, are adapted to a very constant hydrologic regime. Even the most stringent flow control standard employed by this manual does not prevent all increases in runoff volume, and it is known that increased runoff can adversely affect wetland plant communities by increasing the duration and magnitude of water level fluctuations. Thus, compliance with this manual should not be construed as mitigating all probable and significant stormwater impacts to aquatic biota in streams and wetlands; additional mitigation may be required.

Additional mitigation may also be required to compensate for loss of critical drainage area habitat functions associated with activities inside the critical drainage area or critical drainage area buffers.

1.3 Submittal Processes and Requirements

Table 1.3 summarizes the plans and reports that must be submitted for DCD review during the Site Assessment and Planning Review, Preliminary Design Review, and Final Design Review stages. For each stage, the submittal requirements vary based on the type of drainage review applicable to the proposed project (see Table 1.1). See [Volume II, Section 1.4](#)~~below~~ for detailed document contents and format required for each type of drainage review. See also [Volume II, Section 1.2.3](#)~~above~~ for requirements that vary based on the stage of drainage review.

Table 1.3. Summary of Submittal Requirements for Each Review Stage and Type of Drainage Review

Submittal Materials	Type of Drainage Review ^a				
	Simplified Drainage Review	Simplified Drainage Review - Engineered	Abbreviated Drainage Review	Abbreviated Drainage Review - Engineered	Full Drainage Review
<i>Site Assessment and Planning Review</i>					
Application Forms	✓	✓	✓	✓	✓
Site Assessment and Planning Packet	✓	✓	✓	✓	✓
<i>Preliminary Design Review (60-percent design, or higher)</i>					
Site Improvement Plans			✓	✓	✓
Drainage Report				✓	✓
Other technical reports and documents (as applicable)			✓	✓	✓
<i>Final Design Review (90-percent design)</i>					
Site Improvement Plans	✓	✓	✓	✓	✓
Construction Stormwater Pollution Prevention Plan (Construction SWPPP)	✓	✓	✓	✓	✓
Drainage Report		✓		✓	✓
Geotechnical Analysis/Soils Report		✓		✓	✓
Other technical reports and documents (as applicable)	✓	✓	✓	✓	✓

Notes:

a. For permit approval processes between DCD and Kitsap County Public Works, see “Site Development Activity Permit for Capital Projects; Process Procedures”.

a-b. If a project is implementing a TDA approach, engineered review or a full drainage review is required (Volume II, Section 1.2.2).

b-c. For specific application requirements, see [KCC Section 21.04.160](#).

1.4 Submittal Documents

This section details the required contents and formats for plans and reports to be submitted to DCD staff for permit review. [Submittal documents are submitted online per Chapter 21.04 KCC, but shall meet print formatting capability as noted in this section.](#) See Table 1.3 for a summary of which plans and reports are required for each drainage review type and for each stage of review.

1.4.1 Site Assessment and Planning Packet

The Site Assessment and Planning Packet shall demonstrate the methods, sources of information used, and the results of site assessment and planning analyses as described in [Volume II](#), Section 1.2.3.1. The Site Assessment and Planning Packet is organized into the following sections:

1. [Project Information](#) – Includes basic project summary information.
~~2. [Existing Site Composite Map – Combines the information analyzed in Volume I, Chapter 2 into a single site map that is used as the basis for site design.](#)~~
- ~~1-2.~~
- 2-3. [Existing Site Inventory and Analysis Checklist](#) – Documents findings from the inventory and analysis as described in Volume I, Chapter 2.
- ~~3-1. [Existing Site Composite Map – Combines the information analyzed in Volume I, Chapter 2 into a single site map that is used as the basis for site design.](#)~~
4. [Existing and Proposed Site Land Cover Areas](#) – Summarizes existing and proposed site land cover areas. This summary information helps demonstrate compliance with the requirement to minimize impervious area, loss of vegetation, and stormwater runoff.
5. [Proposed Site LID BMP Matrix](#) - Documents LID BMP infeasibility evaluation and provides justification for why individual LID BMPs were included or not included in site plans.

See Appendix C [in Volume II of this manual](#) for [a copy of](#) the Site Assessment and Planning Packet, which shall be completed by the applicant prior to Site Assessment and Planning Review.

1.4.2 Site Improvement Plans

Site improvement plans shall portray design concepts in a clear and concise manner. The plans shall present all information necessary for persons trained in engineering to review the plans, as well as those persons skilled in construction work to build the project according to the design intent. Supporting documentation for the site improvement plans must also be presented in an orderly and concise format that can be systematically reviewed and understood by others.

The site improvement plans consist of all the plans, profiles, details, notes, and specifications necessary to construct road, drainage, grading, site infrastructure and development, utilities, off-

street parking improvements and offsite traffic, stormwater or other offsite mitigation. Site improvement plans include the following, as described below:

1. Base map.
2. Basic site plan requirements and
3. Site plans and profiles.

1.4.2.1 Base Map

A base map provides a common base and reference in the development and design of any project. This component of the site improvement plans helps ensure that the engineering plans, grading plans, and erosion and sediment control (ESC) plans are developed from the same background information. All site improvement plans with multiple sheets must provide the following items on every plan sheet:

- North arrow.
- Graphic scale.
- Title block.
- Revision block.
- Property boundaries.
- All easements to remain.
- Existing utilities to remain, and all associated easements.
- Existing structures (buildings, parking lots and driveways, etc.) to remain.
- Existing natural features such as wetlands, streams, slopes and their associated buffers and applicable construction setbacks.

1.4.2.2 Basic Site Plan Requirements

The basic site plan set shall be formatted as noted below, and shall include the items listed under base map ([Volume II](#), Section 1.4.2.1) plus the following:

- Plan sheets - Required sheet size is 22" x 34" unless waived by the director.
- Datum - All datum shall be either NGVD29 or NAVD88.
- Scale - Preferred horizontal scales are 1" = 20', 1" = 30', 1" = 40' or 1" = 50'. Minimum scale is 1" = 100'. (~~Make the sScale should be~~ as large as ~~the~~ plan sheet size can ~~comfortably reasonably~~ accommodate). Profiles shall use 1" = 5' or 1" = 10' vertical.
- Owner, applicant, and agent information - Name, address, email address, and telephone number.
- Engineer or person preparing the plans - Name, address, email address, and telephone number of the person preparing the plan (Engineer, if an engineered plan).

- Assessor's tax parcel
- Vicinity map – Must be of sufficient clarity to locate the property.
- Symbol legend
- All existing and proposed:
 - Property boundaries with dimensions.
 - Structures and other impervious surfaces such as parking lots, driveways, patios, buildings, etc.
 - Roads and ~~right-of-way~~right of way including roadway and ~~right-of-way~~right of way widths, surfacing and road names.
 - Sanitary sewers and water utilities.
 - Common open space.
 - Public dedications.
 - Other manmade features affecting existing topography or proposed improvements.
 - Easements and tracts.
- Off-site waste treatment systems – Show the location of on-site and adjacent off-site waste treatment systems, such as septic tanks and distribution systems, and on-site and adjacent off-site wells and underground storage tanks, all in accordance with Kitsap Public Health District regulations.
- Existing topography for the project site - At a minimum, topography shall be included for the limits of all land-disturbed area, flow-contributing area and the downstream flow path. Additional topography may be required to address relevant topographic features. Topographic contour lines must be shown as described in the plan type being prepared.
- Land disturbing activity – Show proposed limits of land-disturbing activity.
- Surface water discharge - Provide ground surface elevations for a reasonable "fan" around points of discharge extending at least 50 feet downstream of all point discharge outlets.
- Flow direction - Provide arrows that indicate the direction of surface flow on all public and private property and for all existing conveyance systems.
- Hydrologic features - Provide spot elevations in addition to contour lines to aid in delineating the boundaries and depth of all existing floodplains, wetlands, channels, swales, streams, storm drainage systems, roads (low spots), bogs, depressions, springs, seeps, swales, ditches, pipes, groundwater, and seasonal standing water.
- Revisions - Clearly identify on each sheet, by clouding or other visible notation, all revisions made.

1.4.2.3 Site Plans and Profiles

Site plan and profile requirements, in addition to the base map and basic site plan requirements, are detailed below for each type of drainage review.

Simplified Drainage Review

The Simplified Drainage Review shall contain the base map and basic site plan requirements, plus the following:

1. Existing structures, identifying existing structures to be demolished and existing structures to remain.
2. Proposed structures and distances from lot lines.
3. Setbacks and intended use of each (i.e., side yard setback, top of slope setback, etc.).
4. Clearing limits to show proposed clearing of trees and other vegetation
5. Locations, types, and sizes of conveyance facilities.
6. Locations, types, and sizes of On-site Stormwater Management BMPs.
7. Locations, types, and sizes of erosion and sedimentation control measures.
8. Proposed driveways and access points from parcel to main road.
9. Adjacent property building(s) for shoreline properties.
10. Location of any critical areas and their associated buffer and/or setback requirements.
11. Notes indicating compliance with conditions of approval for any associated plat, short plat, large lot subdivision, or Performance Based Development, if applicable.

Simplified Drainage Review – Engineered

All plan sets submitted for Simplified Drainage Review - Engineered shall be prepared by and bear the stamp of a professional engineer, licensed in the State of Washington. The Simplified Drainage Review – Engineered shall contain the base map, plus the following:

1. Plans drawn on 11" x 17" or larger, to scale, with north arrow, adjacent roadways and property dimensions.
2. Finished grades showing the extent of cuts and fills by existing and proposed contours and profiles.
3. Notation of the quantities of cut and fill, in cubic [feetyards](#), throughout the project site.
4. Topographic contour lines with 2-foot resolution, drawn from the best available source. Note the source used (LIDAR acceptable).
5. Project datum if connecting to a County drainage system or local benchmark otherwise.
6. Plan view of proposed conveyance facilities, including facility sizes, types and materials, lengths of runs and gradients, type of structures, top elevation and invert elevations in/out of structures).

7. Plan view [and cross-section](#) of On-site Stormwater Management BMPs, Flow Control BMPs, and Water Quality Treatment BMPs.
8. Profile of stormwater management facilities if the project is associated with a steep or waterfront slope.
9. Delineation, labeling, and elevation call-out for the Line of Ordinary High Water (where water feature present) in both plan and profile view.
10. Roadway cross-sections (including access roads) and proposed ditches and swales.
11. Critical areas shown (e.g., wetlands, slopes, streams, etc.) with required buffers, setbacks, and any proposed mitigation.

Abbreviated Drainage Review

The Abbreviated Drainage Review shall contain the base map and basic site plan requirements, plus the following:

1. Contour lines from the best available source, spot elevations, or indications of direction and steepness of slopes, with the source clearly identified.
2. Areas to be graded, filled, excavated, or otherwise disturbed. The location of graded slopes shall be indicated, together with the proposed steepness and height. The location of any stockpiles, haul roads and disposal sites shall also be indicated.
3. Grading cross-sections, to scale (minimum of one cross-section in the direction of each slope face).
4. Locations and types of erosion and sedimentation control measures proposed.
5. Plan views of conveyance facilities (e.g., pipes, culverts, channels, swales, structures, etc.) showing the following:
 - a. Conveyance facility locations, sizes, types, materials, lengths of runs, and gradients.
 - b. Structure identifier (catch basin or manhole number).
 - c. Type of structure (e.g., Type 2 Catch Basin).
 - d. Top elevation and invert elevations in/out of structures.
 - e. Outfalls.
 - f. Energy dissipaters.
 - g. Notes or references to details, cross-sections, profiles, etc.
6. Locations, types, and sizes of On-site Stormwater Management BMPs. Include details for construction as needed.

Abbreviated Drainage Review – Engineered

All plan sets submitted for Abbreviated Drainage Review - Engineered shall be prepared by and bear the stamp of a professional engineer, licensed in the State of Washington. The plan sets

shall follow the requirements of site improvement plans and shall contain the base map, basic site plan requirements, plus the following items:

1. Finished grades.
 - a. Show the extent of cuts and fills by existing and proposed contours, profiles, and/or other explicit designations.
 - b. Notation of quantities, in cubic yards, of excavation and/or embankment throughout the project site.
2. Contour lines at 2-foot intervals from the best available source, with the source clearly identified. 5-foot contour intervals may be used in areas of steep slopes. Contours may be limited to the affected portion of the site as described in Item 1, [above](#).
3. Project datum.
4. Plan views of conveyance facilities (e.g., pipes, culverts, channels, swales, structures, etc.) showing the following:
 - a. Exact locations (e.g., station and offset, or dimensioning) of conveyance facilities.
 - b. Conveyance facility sizes, types, materials, lengths of runs, and gradients.
 - c. Structure identifier (catch basin or manhole number).
 - d. Type of structure (e.g., Type 2 Catch Basin).
 - e. Top elevation and invert elevations in/out of structures.
 - f. Outfalls.
 - g. Energy dissipaters.
5. Notes or references to details, cross-sections, profiles, etc.
6. Locations, types, and sizes of On-site Stormwater Management BMPs. Include details for construction as needed.
7. Cross-sections for at least the following:
 - a. Roadways, including access roads.
 - b. Proposed conveyance facilities.
8. Standard plan notes per Appendix B.

In order to minimize duplication of information where plan and profile views appear on the same sheet, drainage facility information provided in the plan view can be limited to the following: structure identifier, type of structure, pipe types and materials, and lengths of runs.

Additional requirements apply to projects that connect to a drainage system in the [right-of-way](#), construct improvements in the [right-of-way](#), or construct improvements in critical areas or critical area buffers, as outlined in the [subsequent](#) sections [below](#).

Projects that connect to a drainage system in the ~~right-of-way~~ [right of way](#)

If the project will connect to a drainage system in the [right-of-way](#) [right of way](#), include the following items in addition to those provided in [Volume II](#), Section 1.4.2.3(d):

1. Profile views shall be provided for drainage and roadways, including:
 - a. Existing and finish grades.
 - b. Existing underground utilities where such utilities cross proposed drainage facilities.
 - a. Conveyance facility (e.g., pipes, culverts, channels, swales, structures, etc.) sizes, types and materials, lengths of runs, gradients, structure types and identifying numbers (if multiple structures), invert elevations in/out of structures, and top elevations of structures.
7. Details of the connection to the drainage system and the energy dissipation structure.
8. Pavement restoration detail.
9. Existing drainage system with elevations and inverts for a minimum of 100 feet upstream and downstream of proposed connection.
10. Proposed means of access to drainage structures.
11. Conveyance calculations and energy dissipation calculations within the Drainage Report.

Projects that construct improvements in the ~~right-of-way~~ [right of way](#)

If the project is associated with an application to use or improve a county [right-of-way](#) [right of way](#) per [Chapter 11.36 KCC](#), the plan submittal shall comply with requirements of [Chapter 11.36 KCC](#) and shall include the following items in addition to those provided in [Volume II](#), Section 1.4.2.3(d):

1. Exact lines, grades, and gradients of proposed roadways.
2. Profiles of drainage facilities and roadways, including:
 - a. Existing and finished grades.
 - b. Existing underground utilities where such utilities cross proposed drainage facilities.
 - c. Conveyance pipe, culvert, channel, and swale sizes, types and materials, lengths of runs, and gradients.
 - d. Structures, including types and identifying numbers (if multiple structures), invert elevations in/out of structures, and top elevations.

Projects that construct improvements in critical areas or critical area buffers

If the project is associated with a critical area or critical area buffer, include the following items in addition to those provided in [Volume II](#), Section 1.4.2.3(d):

1. The critical area being impacted (wetland, slope, stream, etc.) and the proposed mitigation, including details for construction.
2. Documentation from the professional engineer that the proposed mitigation design is in compliance with critical area codes and standards (may be stated on the face of the plans or in the Drainage Report).
3. Documentation of concurrence from wetland biologist, geotechnical consultant and/or other professional, as appropriate, that the engineered design meets the recommendation of the professional.
4. Profile of the drainage system per ~~the Volume II, Section 1.4.2.3(d) above~~, if the project is associated with a steep or otherwise geologically hazardous slope, or waterfront slope.
5. Call-out including label and elevation of the Line of Ordinary High Water, if a waterfront parcel.

Full Drainage Review

All plan sets submitted for Full Drainage Review shall be prepared by and bear the stamp of a professional engineer, licensed in the State of Washington. The plan sets shall follow the requirements of site improvement plans and shall contain the base map and basic site plan requirements, plus the following:

1. Plan view of the entire project site. In the event that the project site is sufficiently large and detailed drainage plans on any given sheet do not encompass the entire project site, the sheet containing the plan view of the entire site shall serve as an index to subsequent detailed plan sheets.
2. Project datum.
3. Locations and elevations of at least two project benchmarks.
4. Existing topography, including existing structures, for the site and extending 50 feet beyond project boundaries. Existing topography for adjacent rights-of-way shall be included for the full width of ~~right-of-way~~right of way. Slopes 30% or steeper shall be clearly identified.
5. Contours extending 50 feet beyond project boundaries and including the full width of adjacent rights-of-way. Contours shall be at 2-foot vertical elevation intervals, except 5-foot intervals may be used in areas of steep slopes.
6. Notation of quantities, in cubic ~~feetyards~~, of excavation and/or embankment throughout the project site.
7. Existing and proposed access locations for the project site.
8. Project boundaries including bearings and dimensions.
9. ~~Right-of-way~~Right of way description including centerline and centerline bearings.
10. Existing utilities including franchised utilities located above or below ground.

11. Locations of existing conveyance facilities that transport surface water onto, across, or from the project site. Existing drainage pipes, culverts, channels, and swales shall include invert or flowline elevations.
12. Location of existing wells and septic components shall be provided on or within 100 feet of project boundaries.
13. Proposed conveyance facilities, including but not limited to pipes, culverts, channels, swales, structures, outfalls, energy dissipaters, etc.
14. Proposed stormwater BMPs, including but not limited to dispersion, bioretention, permeable pavement, ponds, vaults, etc. Include details for construction as needed.
15. Locations of all gutter or ditch flowlines, including flow arrows indicating direction of flow. If a cul-de-sac or hammerhead is proposed as part of roadway system, show spot flowline elevations at 25 feet intervals along the perimeter of the cul-de-sac or hammerhead. Spot elevations at flowlines may also be necessary at intersections.
16. Plan and profile views of conveyance facilities (e.g., pipes, culverts, channels, swales, structures, outfalls, energy dissipaters, etc.) including:
 - a. Exact facility locations (e.g., station and offset, or dimensioning).
 - b. Conveyance facility types, sizes, materials, lengths of runs, and gradients.
 - c. Structure identifier (catch basin or manhole number).
 - d. Type of structure (e.g., Type 2 CB).
 - e. Top elevation and invert elevations in/out of structures.
 - f. Notes or references to details, cross-sections, profiles, etc.

In order to minimize duplication of information where plan and profile views appear on the same sheet, conveyance facility information provided in the plan view can be limited to the following: structure identifier, type of structure, pipe types and materials, and lengths of runs.
17. Plan and profile views of proposed conveyance facilities in existing and proposed public and private roads. In addition to items 16a through f, profile views shall include:
 - a. Existing and finished grades.
 - g. Existing underground utilities where such utilities cross proposed drainage facilities.
18. Notes or call-outs indicating any proposed phasing of construction.
19. Standard plan notes per Appendix B.
20. Details for all proposed drainage structures for which there is insufficient information in the plan view. Details are not required for structures included in the *American Public Works Association (APWA)/Washington State Department of Transportation (WSDOT) Standard Plans*, provided that the specific *APWA/WSDOT Standard Plans* are referenced in the construction notes.

21. Cross-sections for at least the following:

- a. Roadways, including access roads.
- b. Surveyed cross-sections for new roadways, frontage improvements and/or roadway widening.
- c. Proposed On-site Stormwater Management, Flow Control, and Water Quality Treatment BMPs.
- d. Proposed ditches and swales, including bioretention facilities.

1.4.3 Construction Stormwater Pollution Prevention Plan

All Construction SWPPPs for large projects that trigger Minimum Requirements #1 through #9 shall be prepared by and bear the stamp of a professional engineer, licensed in the State of Washington. The Construction SWPPP shall address the thirteen required elements per Volume II, Chapter 2 [of this manual](#).

Construction SWPPPs for small projects that trigger Minimum Requirements #1 through #5 only do not have to be prepared by an engineer unless the specific small project requires engineering. The Construction SWPPP shall address the thirteen required elements per Volume II, Chapter 2 [of this manual](#).

Plans submitted for review shall include the following narrative and plan elements described below, at a minimum.

1.4.3.1 Narrative

1. Required elements - Describe how the Construction SWPPP addresses each of the 13 required elements. (See Volume II, Chapter 2). Include the type and location of BMPs used to satisfy the required element. If an element is not applicable to a project, provide a written justification for why it is not necessary.
2. Project description - Describe the nature and purpose of the construction project. Include the total size of the area, any increase in existing impervious area; the total area expected to be disturbed by clearing, grading, excavation or other construction activities, including off-site borrow and fill areas; and the volumes of grading cut and fill that are proposed.
3. Existing site conditions - Describe the existing topography, vegetation, and drainage. Include a description of any structures or development on the parcel including the area of existing impervious surfaces.
4. Adjacent areas - Describe adjacent areas, including streams, lakes, wetlands, residential areas, and roads that might be affected by the construction project. Provide a description of the downstream drainage leading from the site to the receiving body of water.
5. Critical areas - Describe areas on or adjacent to the site that are classified as critical areas per Title 19 KCC. Critical areas that receive runoff from the site shall be described up to ¼ mile downstream, or for the distance required by the downstream analysis,

whichever is greater. Describe special requirements for working near or within these areas.

6. Soil - Describe the soil on the site, giving such information as soil names, mapping unit, and erodibility, settleability, permeability, depth, texture, and soil structure.
7. Potential erosion problem areas - Describe areas on the site that have potential erosion problems. Include a completed Construction Site Sediment Transport Potential Worksheet ([see Volume II](#), Appendix E).
8. Construction phasing - Describe the intended sequence and timing of construction activities.
9. Construction schedule - Describe the construction schedule. If the schedule extends into the wet season, describe what activities will continue during the wet season and how the transport of sediment from the construction site to receiving waters will be prevented.
10. Financial/ownership responsibilities - Describe ownership and obligations for the project. Include bond forms and other evidence of financial responsibility for environmental liabilities associated with construction.
11. Engineering calculations – Attach any calculations made for the design of such items as sediment ponds, diversions, and waterways, as well as calculations for runoff and stormwater detention design (if applicable). Engineering calculations shall bear the signature and stamp of an engineer licensed in the state of Washington.
12. CESCL - A responsible CESCL shall be identified in accordance with Volume II, Chapter 2.
13. Contact Information - Telephone numbers [and email addresses](#) shall be included.

1.4.3.2 Plans

The Construction SWPPP shall follow the format requirements of site improvement plans (see [Volume II](#), Section 1.4.2) and shall contain the following information:

- Basic site plan requirements - All information required per the basic site plan requirements.
- Existing topography - Existing topography, as per the requirements for Full Drainage Review.
- Finished grade
- Phasing - If the site will be cleared in phases, each phase shall meet all requirements of this chapter. The phasing of any erosion and sedimentation control work shall be clearly indicated on the Plan.
- CESCL - The name, address, and contact information of the designated erosion control lead as required in Volume II, Chapter 2.
- Construction sequencing - A detailed listing of the construction sequence.

- Soil types - The boundaries of and labels for different soil types.
- Erosion areas - Areas of potential erosion problems.
- Discharge locations - Locations where stormwater discharges to surface waters during and upon completion of construction.
- Conveyance systems - Show on the site map the following temporary and permanent conveyance features:
 - Locations for swales, interceptor trenches, or ditches.
 - Drainage pipes, ditches, or cut-off trenches associated with erosion and sediment control and stormwater management.
 - Temporary and permanent pipe inverts and minimum slopes and cover.
 - Grades, dimensions, and direction of flow in all ditches and swales, culverts, and pipes.
 - Details for bypassing off-site runoff around disturbed areas.
 - Locations and outlets of any dewatering systems.
- Location of flow control BMPs - Show on the site plans the locations of any Flow Control BMPs.
- Erosion and Sediment Control (ESC) BMPs - Show on the site plans all structural and nonstructural ESC BMPs including:
 - The location of sediment pond(s), pipes and structures.
 - Dimension pond berm widths and inside and outside pond slopes.
 - The trap/pond storage required and the depth, length, and width dimensions.
 - Typical section views through pond and outlet structure.
 - Typical details of gravel cone and standpipe, and/or other filtering devices.
 - Stabilization technique details for inlets and outlets.
 - Control/restrictor device location and details.
 - Stabilization practices for berms, slopes, and disturbed areas.
 - Rock specifications, spacing, sections and detail for rock check dam, if used.
 - The location, detail, and specification for silt fence.
 - The construction entrance location and a detail.
- Other pollutant BMPs - Indicate on the site map the location of BMPs to be used for the control of pollutants other than sediment (e.g., BMPs for commercial composting; refer to Volume II, Chapter 3 ~~of this manual~~).
- Standard plan notes – Include standard plan notes per Appendix B.

1.4.4 Drainage Reports

The Drainage Report shall be [formatted to fit](#) 8-1/2" x 11" paper and [printed](#) maps shall be folded to 8-1/2" x 11" size unless another format is approved prior to submittal. All Drainage Reports shall be prepared by and bear the stamp and dated signature of a professional engineer licensed in the State of Washington and shall contain the following information, at a minimum:

- Cover sheet - Include the project name, proponent's name, address and telephone number, project engineer, and date of submittal.
- Table of Contents - Show the page numbers for each section of the report, including appendices.
- Project overview – Include the following information:
 - Relevant project background information.
 - Size and location of the project site, including address and tax parcel number(s) of the property.
 - Vicinity map.
 - Project description, including proposed land uses, proposed site improvements, proposed construction of hard surfaces, proposed landscaping, proposed permanent stormwater management facilities, etc.
 - Discussion of how LID techniques were utilized to minimize impervious surfaces, loss of vegetation, and stormwater runoff. Refer to the Site Assessment and Planning Packet, to be included as an appendix, and describe how findings during the site analysis and planning stage were incorporated into preliminary and final designs.
 - List and description of the applicable design standards, documents, and requirements that were used as the basis for drainage design, including but not limited to this manual, the [Ecology Manual](#), and the LID Technical Guidance Manual for Puget Sound ([Hinman and Wulkan, 2012](#)).
- Existing site conditions – Include the following information:
 - Description of site topography, land cover, and land use.
 - Basin map:
 - Show boundaries of project, any off-site contributing drainage basins, on-site drainage basins, approximate locations of all major drainage structures within the basins, and depict the course of stormwater originating from the subject property and extending all the way to Puget Sound or to the closest receiving body of water (lakes, creeks, etc.).
 - Reference the source of the topographic base map (e.g., survey), the scale of the map, and include a north arrow.

- Show site topography, land cover, and all drainage features on-site. Depict and note on the basin map the acreage of each type of land cover (pervious, impervious, buildings, driveways, etc.).
 - Tabulation of land cover types and acreages.
 - Abutting property land cover and land use.
 - Off-site drainage tributary to the project site.
 - Existing natural and manmade drainage facilities within and immediately adjacent to the project site, points of discharge for existing drainage from the project site, and receiving water body.
 - Sensitive areas, including creeks, lakes, ponds, wetlands, ravines, gullies, steep slopes, springs, groundwater sensitive areas, and other environmentally sensitive areas on or adjacent to the project site. For groundwater sensitive areas, reference applicable reports and include well locations.
 - Existing trees and vegetation.
 - Existing drainage or erosion problems on-site.
 - Existing drainage or erosion problems upstream or downstream of the project site which may impact the proposed site development and drainage designs.
 - General soil and groundwater conditions.
 - Reference to the Site Assessment and Planning Packet, to be included in the appendix. Document [if-whether](#) existing site conditions were found to vary from those documented in the Site Assessment and Planning Packet during the course of design, and how those variations affected minimization of impervious surfaces, loss of vegetation, and runoff generation, as well as BMP selection, if applicable.
 - References to relevant reports such as basin plans, flood studies, groundwater studies, wetland designation, critical area designation, environmental impact statements, lake restoration plans, water quality reports, etc. Where such reports impose additional conditions on the project, those conditions shall be included in the Drainage Report.
- Proposed site conditions – Include the following information:
 - Description of proposed changes to site topography as a result of grading, land cover, and land use.
 - Basin map:
 - Show boundaries of project, any off-site contributing drainage basins, on-site drainage basins, approximate locations of all major drainage structures within the basins, and depict the course of stormwater originating from the subject property and extending all the way to Puget Sound or to the closest receiving body of water (lakes, creeks, etc.).

- Reference the source of the topographic base map (e.g., survey), the scale of the map, and include a north arrow.
 - Show proposed topography, land cover, and all proposed conveyance, on-site stormwater management, flow control, and water quality treatment facilities. Depict and note on the basin map the proposed acreage of each type of land cover (pervious, impervious, buildings, driveways, etc.).
- For projects implementing a TDA approach (see Volume I, Section 3.8):
 - TDA Delineation map
 - For large projects that trigger MR #1-9 (see KCC 12.08.275) and implement TDAs, provide a summary table that includes the following for each TDA (Refer to Volume III-3.2 of the Ecology Manual for additional guidance):
 - ◆ New pollution-generating hard surfaces (PGHS)
 - ◆ Replaced PGHS (where the replaced hard surfaces have been determined to be subject to requirements per Volume I, Section 4.1)
 - ◆ Effective impervious surfaces, and
 - ◆ Converted vegetated areas (to determine whether Runoff Treatment and/or Flow Control BMPs are necessary to comply with Volume I, Section 4.2.6 and Volume I, Section 4.2.7)
- Tabulation of proposed land cover types and acreages.
 - Potential stormwater quantity and quality impacts resulting from the proposed project.
 - Minimum requirements that pertain to the project.
 - Drainage-related requirements beyond the minimum requirements that pertain to the project.
 - Proposed permanent stormwater management plan to address the minimum requirements and other drainage-related requirements, including conveyance, on-site stormwater management, flow control, and water quality treatment facilities.
- Infiltration feasibility assessment and infiltration BMP design – Provide a summary of the relevant Geotechnical Analysis/Soils Reports (Volume II, Section 1.4.5) prepared for the project. The summary shall include discussion of the methods, assumptions, results, and recommendations regarding infiltration feasibility and design of infiltration BMPs, and how those recommendations were used to support design. Include the full Geotechnical Analysis/Soils Reports in an appendix or multiple appendices, as appropriate.
 - Downstream analysis - Include a Level 1 downstream drainage analysis prepared in accordance with the requirements in Volume II, Chapter 4. This Level 1 analysis, as well as the location of the project in a drainage basin, will be reviewed by the County to determine whether a Level 2 and/or Level 3 downstream analysis will be required. Any

further analysis of downstream conditions required beyond the Level 1 analysis shall become a part of the Drainage Report and shall be submitted as part of the Drainage Report.

- Hydrologic/Hydraulic analysis – Discuss the modeling methods and software programs used to size conveyance facilities, including outfalls and energy dissipation, and On-site Stormwater Management, Flow Control, and Water Quality Treatment BMPs. Include the version of the software programs being used. Include sScreen shots of the facility design from the modeling software ~~should also be included~~. Include complete model output reports in the appendices, annotated as appropriate to highlight assumptions, rationale for any non-standard model inputs used, interpretation of key results, etc. to aid review of the modeling.
- Operation and Maintenance (O&M) – List the standards and guidelines used to develop long-term O&M requirements for the permanent stormwater BMPs included in the designs. Provide a complete O&M manual in an appendix to the Drainage Report, detailing specific maintenance activities, frequencies, responsible parties, equipment needs, conditions triggering O&M, etc. See Chapter 7 of Volume II, Chapter 7 of this manual for additional O&M requirements.
- Appendices - Include a copy of the completed Site Assessment and Planning Packet (Volume II, Section 1.4.2), relevant sheets from the site improvement plans (e.g., grading, paving, tree protection, drainage plans and profiles, etc.), Geotechnical Analysis/Soils Reports (Volume II, Section 1.4.5), model outputs and reports, site photographs as appropriate, O&M manual, and any additional relevant reports which support or corroborate the findings, conclusions, or assumptions contained in the Drainage Report.

1.4.5 Geotechnical Analysis/Soils Reports

Geotechnical analysis/soils reports are required to document subsurface investigations, groundwater monitoring, characterization of infiltration receptor, and groundwater mounding and seepage analyses, per Chapter 5 of Volume II, Chapter 5 of this manual. In addition, KCC Section 19.700.725 requires a geotechnical report whenever development is proposed in a geologically hazardous area or shoreline setback, or when DCD determines that additional soils and slope analysis is appropriate on a particular site.

The following report types may be combined or provided separately, depending on who prepares the reports and approval by DCD reviewers to combine reports. Where a licensed professional is required to prepare reports, the reports ~~shall bear~~ shall bear the signature and stamp of the licensed professional in the state of Washington. Where provided separately, the Drainage Report shall reference other reports by title, date, and name of company or licensed professional.

The minimum information to be included in each report is detailed below:

1. Geotechnical analysis – Provide the following:

- a. Potential impact of stormwater BMPs on slopes 15% or greater or otherwise sensitive slopes, per [Chapter 5 of Volume II, Chapter 5 of this manual](#).
 - b. For BMPs setback less than 50 feet from steep slopes, information necessary to support the proposed setback.
 - c. Information required per [KCC Section 19.700.725](#).
 - d. Results and conclusions.
 - e. Raw data and calculations, to be included in an appendix.
2. Subsurface investigations and infiltration testing – For projects required to perform subsurface investigations and infiltration testing per Volume II, Chapter 5 [of this manual](#), provide the following:
- a. Simple Subsurface Investigation Report, Standard Subsurface Investigation Report, or Comprehensive Subsurface Investigation Report, as required per Volume II, Chapter 5 [of this manual](#).
 - b. Small Pilot Infiltration Test Report, Large Pilot Infiltration Test Report, and/or Deep Infiltration Test Report, as required per Volume II, Chapter 5 [of this manual](#).
 - c. For all subsurface investigation and infiltration testing reports, provide the following:
 - i. Description of the methods used and the standards upon which the methods were based.
 - i. Maps of investigation and testing locations.
 - ii. Discussion of soil and groundwater conditions found.
 - iii. Results and conclusions.
 - iv. Raw data and calculations, to be included in an appendix.
3. Groundwater monitoring - For projects required to perform groundwater monitoring per Volume II, Chapter 5 [of this manual](#), provide the following:
- a. Description of methods used and the standards upon which the methods were based.
 - b. Map of monitoring locations relative to the project site.
 - c. Description of groundwater levels relative to the investigation depth and vertical separation requirements per Appendix G, Section G.2 [of this manual](#).
 - d. Results and conclusions.
 - e. Raw data and calculations, to be included in an appendix.
4. Characterization of infiltration receptor - For projects required to perform characterization of infiltration receptor per Volume II, Chapter 5 [of this manual](#), provide the following:

- a. Depth to groundwater and to ~~hydraulically restrictive~~ hydraulically restrictive material.
 - b. Seasonal variation of groundwater table based on well water levels and observed mottling of soils.
 - c. Existing groundwater flow direction and gradient.
 - d. Approximation of the lateral extent of infiltration receptor.
 - e. Volumetric water holding capacity of the infiltration receptor soils. The volumetric water holding capacity is the storage volume in the soil layer directly below the infiltration facility and above the seasonal high groundwater mark, or hydraulically- restrictive material.
 - f. Horizontal hydraulic conductivity of the saturated zone to assess the aquifer's ability to laterally transport the infiltrated water.
 - g. Results and conclusions.
 - h. Raw data and calculations, to be included in an appendix.
5. Groundwater mounding and seepage analysis - For projects required to perform groundwater mounding and seepage analysis per Volume II, Chapter 5 ~~of this manual~~, provide the following:
- a. Description of data used.
 - b. Analysis procedures, including modeling tools and methods.
 - c. Potential for groundwater mounding or seepage as a result of proposed infiltration facilities.
 - d. Results and conclusions.
 - e. Raw data and calculations, to be included in an appendix.

1.4.6 Single Family Residential Subdivision Design Submittals

The minimum design assumptions per single family residential subdivision lot shall be stated on the face of the SDAP plans and on the face of the final plat, in a format similar to the following:

<u>Lot No.</u>	<u>Minimum design allotment of hard surface area in square feet examples (sidewalk, driveway, roof areas, concrete porches)</u>		<u>Minimum design allotment of developed pervious surface</u>	<u>Surplus Total available for individual lot design x,xxx square feet</u>
<u>Lot 1</u>				
<u>Lot 2</u>				
<u>Lot 3</u>				

Lot 4				
Lot 5				
Cumulative Totals				

[If surplus stormwater mitigation is provided for the subdivision to allow flexibility in individual lot design, that surplus availability shall be stated in square feet on the face of the final construction drawings and final plat. Usage of the surplus area by individual lot development may be considered when the design does not cause noncompliance with any conditions of subdivision approval or other applicable regulations.](#)

[In addition, for individual lot development where hard surfaces are directed to more than one stormwater BMP, a breakdown of the various surface areas \(e.g., roof, driveway, etc.\) shall be included in the chart on the face of the final plat.](#)

~~1.4.6~~1.4.7 Other Reports

Other reports may be required in accordance with [KCC Section 19.700.705](#) to provide environmental information and to present proposed strategies for maintaining, protecting and/or mitigating critical areas. See ~~[KCC 19.700.705](#)~~[the referenced code section](#) for Wetland Delineation Report/Wetland Mitigation Plan, Habitat Management Plan, and Hydrogeological Report requirements. Other reports may also be required by other agencies ([Volume II](#), Section 1.2.4) and/or to support additional drainage design requirements beyond the minimum stormwater requirements ([Volume II](#), Section 1.2.5).

1.5 Permit Issuance

Once all requirements have been addressed, the SDAP will be issued after the pre-construction meeting and submittal of the following:

1. Payment of all permit fees.
2. Evidence of issuance of any permits required by other agencies.
3. Performance surety or Performance Covenant for Site Stabilization in accordance with [Chapter 12.12 KCC](#).
4. Evidence of liability insurance in accordance with [KCC Section 12.12.050](#).
5. Recording of any required off-site construction-related easements.
6. Submittal of a completed Construction Site Sediment Transport Potential Worksheet (see ~~[Volume II](#)~~, Appendix [E2](#)). Development sites that have a high potential for sediment transport require a pre-inspection by [Kitsap County](#) staff prior to permit issuance.

For land use permits and approvals not requiring an SDAP, but subject to drainage review, approval will be recommended in accordance with [Volume II](#), Section 1.5.2.

1.5.1 Pre-construction Meeting

All SDAPs require a pre-construction meeting prior to issuance [of the Site Development Activity Permit/SDAP](#). Other small projects may also require a pre-construction meeting. For projects that require a pre-construction meeting, no work shall take place on a project site prior to the pre-construction meeting.

In the event that work takes place on the project site prior to the pre-construction meeting, the owner and/or contractor shall be in violation of [KCC Section 12.10.030](#) and shall be subject to a monetary penalty as described in the [KCC Kitsap County Code](#). In addition, the issuance of the SDAP or other permit may be delayed, and restoration work may be required for those areas of the site disturbed prematurely.

The pre-construction meeting shall be attended by:

- The owner or an authorized representative of the owner.
- The designated Certified Erosion and Sediment Control Lead (CESCL), or emergency contact person, if a CESCL is not required.
- The project engineer.
- A representative of the general contractor.
- A representative of Kitsap County.
- Representatives from all affected utilities.

The agenda for the pre-construction meeting shall include at least the following:

1. Verification that all required permits have been issued, which may include but is not limited to land use permits, building permits, Hydraulic Project Approvals, Construction Stormwater General Permits, etc.
2. Issuance of the SDAP placard, to be posted on the project site.
3. Verification that the contractor is in possession of current final approved plans.
4. Discussion of the duties of the designated CESCL or emergency contact person.
5. Discussion of coordination of work by affected utilities.
6. Discussion of Kitsap County requirements concerning erosion control and construction sequence, inspection requirements, plan changes, and protection of critical drainage areas.

1.5.2 Final Project Approval

Kitsap County will not recommend final project approval or the granting of certificates of occupancy, and will not release financial securities until the following applicable items have been completed:

1.5.2.1 Simplified Drainage Review and Abbreviated Drainage Review

For projects requiring a Simplified Drainage Review or an Abbreviated Drainage Review, the conditions of the review approval shall be met, except that final landscape planting may be delayed to the appropriate season for said planting.

1.5.2.2 Simplified Drainage Review – Engineered, Abbreviated Drainage Review – Engineered, and Full Drainage Review

For projects requiring Simplified Drainage Review – Engineered, Abbreviated Drainage Review – Engineered, or Full Drainage Review, (except that these final approval requirements may be modified on a case by case basis by Kitsap County):

1. Completion, to the satisfaction of the director, of all work indicated on the plans.
2. Certification, by the project engineer, of the as-built live and dead storage pond volumes, as applicable.
3. Certification, by the project engineer, that all pond side slopes are 2H: 1V or flatter for fenced ponds, and 3H: 1V or flatter for unfenced ponds.
4. Infiltration verification for infiltration facilities designed to meet Minimum Requirements #5, 6, and 7 as required per Volume II, Chapter 5.
5. Record drawings
6. Submittal of ~~one set of reproducible mylara~~ complete set of record drawings ~~or including~~ an electronic version ~~of same~~ in portable document format (PDF) along with two sets of full-sized copies. Record drawings shall include:
 - a. The complete approved plan set, except for erosion control and grading, and including all road and drainage plans, profiles and associated details.
 - b. Record drawings shall incorporate all deviations, both horizontal and vertical, to the original approved design. Items not built shall be crossed out. Record drawings shall be accurate, clean, clear and easily readable.
 - c. The record drawing set shall be stamped "RECORD DRAWING" and shall be signed and sealed by a professional engineer or land surveyor, and shall contain the following statement:
 - d. "I hereby certify that, based on field verification, the constructed stormwater facilities represented by this record drawing will perform as intended, subject to proper operation and maintenance."
7. Submittal of a recorded (with the Kitsap County Auditor) Maintenance Covenant for maintenance of private storm drainage facilities which gives Kitsap County the right to inspect the facilities and guarantees the County that the facilities will be properly maintained. A standard Maintenance Covenant form is available from DCD.
8. Review and approval by the director of the final plat map and associated documentation, if applicable.

9. Submittal of Recorded (with the Kitsap County Auditor) Covenants, Conditions and Restrictions; maintenance easements; agreements with adjacent property owners; conservation easements; and similar documents as required in the approved plans, State Environmental Policy Act (SEPA) conditions, or conditions of preliminary approval.
10. Fulfillment of all conditions of approval.
11. Permanent stabilization and restoration of the project site. Final replanting may be delayed to the appropriate season, provided that temporary soil stabilization measures are in place and financial security is provided to assure the completion of work.
12. Submittal, by the project engineer, of the Operation and Maintenance Manual for privately maintained and/or non-standard stormwater facilities (see Volume II, Chapter 7 for requirements).
13. Payment of any outstanding fees.
14. Submittal of any required maintenance bonds.

1.5.2.3 Changes to a Previously Approved Stormwater Site Plan

Changes to a previously approved stormwater site plan shall be in accordance with KCC Section 12.10.100.

1.5.3 Performance Bond for uncompleted Subdivision improvements

For final plats that will be recorded prior to construction completion, performance sureties may be accepted in accordance with KCC Section 12.12.040 in lieu of the final project approval items listed above in Volume II, Section 1.5.2. However, in no event shall a performance surety be accepted in lieu of construction completion for subdivisions with private roads, ~~and or for the completion of~~ safety items including but not limited to guardrails or pond fencing.

1.5.4 Transfer of Engineering Responsibilities

If the engineer of record is changed during the course of the work, ~~the work~~ all work other than erosion control shall be stopped until the replacement engineer has agreed to accept the responsibilities of the project engineer.

1.5.5 Project Phasing

The phasing of construction is permitted when in accordance with current land use codes, policies, conditions of preliminary approval, and SEPA conditions.

The site improvement plans for the initial phase of a project shall incorporate all conveyance, On-site Stormwater Management, Flow Control, Water Quality Treatment, and erosion control BMPs necessary to serve the initial phase as if no further construction were to take place (i.e., a "stand alone" project).

It is of particular importance that runoff control facilities be designed so that stormwater release rates for each phase do not exceed allowable release rates for a given stage of "build-out." It

will sometimes be necessary that the control structure be modified with each additional construction phase. With the addition of each phase of development, the project shall maintain its ability to "stand alone" without dependence on future phases of development.

In the event that the scope of the site improvement plans includes the entire project with all of its phases, the plans shall clearly indicate phasing limits for land clearing, erosion control, grading, construction of drainage facilities, and construction of impervious surfaces.

1.5.6 Permit Extensions and Renewals

Site Development Activity Permits may be renewed or extended in accordance with KCC Section 12.10.055:

1. To request an extension of an approved, unissued permit, the owner or authorized representative shall provide a written request to Kitsap County DCD for permit extension prior to the expiration date. The request shall reference the permit number, original approval date, and the reason for the request.
2. To request a renewal of an expired, issued permit, the owner or authorized representative shall provide:
 - a. A written request to Kitsap County DCD for permit renewal. The request shall reference the permit number, original approval date and the reason for the request.
 - b. A renewal fee per KCC 21.10.010 or as amended.

Expired permits will be permanently closed if not renewed within 180 days of expiration. Once a permit is permanently closed it will not be renewed or extended. New permit applications and fees per KCC 21.10.010 are required prior to any project activity.

CHAPTER 2 CONSTRUCTION STORMWATER POLLUTION PREVENTION

2.1 Introduction

~~Volume II of the Ecology Manual, Construction Stormwater Pollution Prevention, and local amendments included in this chapter describe the requirements for meeting Construction Stormwater Pollution Prevention (Construction SWPPP, Minimum Requirement #2) per Volume I, Section 4.2.2. Section 3.4.2 of the Ecology Manual requires submittal. Volume II, Chapter 2 of the Ecology Manual as modified herein provides requirements for the development of Construction Stormwater Pollution Prevention Plans (SWPPP) and reports for review by the Kitsap County Department of Community Development (DCD). Requirements for meeting Construction Stormwater Pollution Prevention (SWPP) are contained in Volume II of the Ecology Manual. Development of Construction SWPPPs and reports are contained in Volume II, Chapter 2 of the Ecology Manual.~~

The Construction SWPPP designer shall evaluate the stormwater management requirements for the entire project, with input from utilities and other contractors, the stormwater management requirements for the entire project, including ~~the~~ utilities, when preparing the Construction SWPPP. The designer shall consult with and request input from the appropriate utility purveyors and contractors as needed.

For small projects (Chapter 12.08 KCC) eligible for Simplified Drainage Review and Abbreviated Drainage Review in accordance with Volume II, Chapter 1, ~~obtain complete~~ a narrative checklist and SWPP site plan template (available on Kitsap County's Department of Community Development [DCD] website) ~~from DCD that can be used~~ in lieu of preparing a full Construction SWPPP.

2.2 Construction Stormwater BMPs

See Volume II, Chapter 3 of the Ecology Manual for construction stormwater best management practices (BMPs) that are temporary BMPs to be used as appropriate during the construction phase of a project. The construction stormwater BMPs are divided into two categories: Construction Source Control BMPs and Construction Runoff BMPs. Construction SWPPPs can contain experimental BMPs or make minor modifications to standard BMPs. However, the permitting authority (state, local, or both) must approve such practices before use. Experimental and modified BMPs must achieve the same or better performance than the BMPs listed in Volume II, Chapter 3 of the Ecology Manual. Regular inspections and maintenance are key to successful implementation of construction stormwater BMPs.

2.3 ~~Local Amendments to Volume II of the Ecology Manual~~

~~This section presents three local amendments to Volume II of the Ecology Manual with respect to implementing Minimum Requirement #2 in Kitsap County. All other sections of Volume II of~~

the Ecology Manual that are not amended herein shall be applied as is in accordance with the Ecology Manual:

- Amend the third paragraph of Section 2.2 of Volume II of the Ecology Manual to read:

~~“The Construction SWPPP must include the 13 elements described in Chapter 3 of Volume II of the Ecology Manual unless site conditions render any of the elements unnecessary and the exemption from that element is clearly justified in the Construction SWPPP.”~~

- Amend the sixth paragraph of Section 3.1.3 of Volume II of the Ecology Manual to read:

~~Whether the stormwater discharges to surface water or completely infiltrates, each of the 13 elements must be included in the Construction SWPPP, unless an element is determined not to be applicable to the project and the exemption is justified in the narrative.~~

- Amend the second bullet point of Section 3.2.1 of Volume II of the Ecology Manual to read:

~~Thirteen (13) elements: Describe how the Construction SWPPP addresses each of the 13 required elements. Include the type and location of BMPs used to satisfy the required element. Often using a combination of BMPs is the best way to satisfy required elements. If an element is not applicable to a project, provide a written justification for why it is not necessary.~~

CHAPTER 3 SOURCE CONTROL OF POLLUTION

3.1 Introduction

This chapter and [Volume IV of the Ecology Manual](#) describe the requirements for meeting Minimum Requirement #3 - Source Control of Pollution per Volume I, [Section 4.2.3](#)~~Chapter 4 of this manual.~~

Source control [best management practices \(BMPs\)](#) are structures or operations that are intended to prevent pollutants from coming into contact with stormwater through physical separation of areas or careful management of activities that are sources of pollutants (e.g., commercial composting).

3.2 ~~Project Submittal Requirements~~ **Minimum Requirement #3—Source Control of Pollution**

~~All known, available and reasonable source control BMPs shall be applied to all projects. Source control BMPs shall be selected, designed, and maintained according to this manual.~~

~~The intent of source control BMPs is to prevent stormwater from coming in contact with pollutants. They are a cost effective means of reducing pollutants in stormwater, and, therefore, should be a first consideration in all projects.~~ Source Control BMPs, including operational and structural BMPs, shall be identified in the Site Improvement Plans and shall be shown on site plans submitted for [Kitsap County Department of Community Development \(DCD\)](#) review; see Volume II, Chapter 1 ~~of this manual~~ for project submittal requirements.

~~BMPs for long-term control of stormwater at developed sites can be divided into three main categories:~~

~~BMPs addressing the volume and timing of stormwater flows;~~

~~BMPs addressing prevention of pollution from potential sources; and~~

~~BMPs addressing treatment of runoff to remove sediment and other pollutants.~~

3.3 Operation and Structural Source Control BMPs

There are two categories of source control BMPs: operational and structural. Operational source control BMPs are non-structural practices that prevent or reduce pollutants from entering stormwater. Examples include formation of a pollution prevention team, [good housekeeping practices](#), preventive maintenance/[good housekeeping procedures](#), spill prevention and cleanup, employee training, inspections ~~of pollutant sources~~, and record keeping. They can also include process changes, raw material/product changes, and recycling wastes. Operational source control BMPs are considered the most cost-effective pollutant minimization practices.

Structural source control BMPs are physical, structural, or mechanical devices or facilities that are intended to prevent pollutants from entering stormwater. Examples of structural source control BMPs include:

- Enclosing and/or covering the pollutant source (e.g., within a building or other enclosure, a roof over storage and working areas, temporary tarp, etc.).
- Physically segregating the pollutant source to prevent run-on of uncontaminated stormwater.
- Devices that direct only contaminated stormwater to appropriate treatment BMPs (e.g., discharge to a sanitary sewer if allowed by the local sewer authority).

~~3.1 Treatment BMPs for Specific Pollutant Sources~~

~~Treatment BMPs include settling basins or vaults, oil/water separators, wetponds, constructed wetlands, infiltration systems, and emerging technologies such as media filtration.~~

3.4 Selection of Operational and Structural Source Control BMPs

~~Urban stormwater pollutant sources include manufacturing and commercial areas; high use vehicle parking lots; material (including wastes) storage and handling; vehicle/equipment fueling, washing, maintenance, and repair areas; erodible soil; streets/highways; and the handling/application of de-icers and lawn care products. Reduction or the elimination of pollutants with the potential to be conveyed by stormwater runoff can be achieved by implementing operational source control BMPs, including good housekeeping, employee training, spill prevention and cleanup, preventive maintenance, regular inspections, and record keeping.~~

Select operational and structural source control BMPs in accordance with [Volume III, Section 1.1 of the Ecology Manual](#). ~~These BMPs can be combined with impervious containments and covers, i.e., structural source control BMPs. The selection of source control BMPs shall be based on land use and the pollutant generating sources. Refer to [Volume IV, Appendix IV-A of the Ecology Manual](#) for a description of the various land uses and activities and the potential pollutant generating sources associated with those activities.~~

3.4.1 When are Source Control BMPs Required?

Implement source control BMPs at:

- [Commercial properties](#)
- [Industrial properties](#)
- [Multifamily properties](#)
- [Boatyards](#)
- [Sand and gravel mining operations](#)

[Regulatory programs such as the State Environmental Policy Act \(SEPA\), Water Quality Certifications, and Hydraulic Project Approvals may require use of source control BMPs.](#)

3.4.2 How to Determine Which Source Control BMPs are Appropriate for the Site

Volume IV of the Ecology Manual provides Ecology's library of source control BMPs. These BMPs are categorized as either "operational" or "structural", and either "applicable" or "recommended".

For the sites that must implement source control BMPs listed in Volume II, Section 3.4.1, use the following steps to guide selection of appropriate source control BMPs:

1. All sites must implement the source control BMPs listed in Volume IV, Chapter 1 of the Ecology Manual.

14.2. Next, base selection of additional source control BMPs on land use and the pollutant generating sources at the site.

- o Use Appendix IV-A of the Ecology Manual to help determine activities and the potential pollutant generating sources associated with those activities for various land uses.
- o Applicable operational and structural source control BMPs for each pollutant source can then be selected by reviewing the BMPs in Volume IV of the Ecology Manual, which are categorized by activity. Consider implementing source control BMPs for land uses and pollutant sources not included in Ecology Manual Appendix IV-A.

For example, if a commercial printing business conducts weed control with herbicides, loading and unloading of materials, and vehicle washing, see the following BMPs:

- o S411 BMPs for Landscaping and Lawn / Vegetation Management
- o S412 BMPs for Loading and Unloading Areas for Liquid or Solid Material
- o S431 BMPs for Washing and Steam Cleaning Vehicles / Equipment / Building Structures
- o S404 BMPs for Commercial Printing Operations

3. Within the text for each source control BMP, there are "applicable" and "recommended" BMPs listed.

Interpret the term "applicable" when referring to specific operational or structural source control BMPs as meaning "mandatory" or "required". These BMPs must be implemented at the site.

"Recommended" Source Control BMPs are approaches that go beyond or complement the applicable (mandatory) BMPs. Implementing the recommended source control BMPs may improve control of pollutants and provide a more comprehensive and environmentally effective stormwater management program. All operators are encouraged to review their SWPPPs and use recommended BMPs where possible.

4. The project may have additional source control responsibilities as a result of area-specific pollution control plans (e.g., watershed or basin plans, water clean-up plans,

ground water management plans, lakes management plans), ordinances, and regulations.

For New and Redevelopment Project Proponents, if the project involves any of the activities described in Volume IV of the Ecology Manual, the “applicable” structural source control BMPs described in that section must be constructed as part of the project. In addition, if the specific business enterprise that will occupy the site is known, the “applicable” operational source control BMPs must also be identified. Specific requirements related to Industrial Stormwater permittees, Boatyard permittees, and Sand and Gravel permittees are included in Volume II, Section 3.4.1.

3.5 Local Amendments to Operational and Structural Source Control BMPs

Refer to Volume IV of the Ecology Manual to select source control BMPs. The following BMPs have local amendments:

- S427: BMPs for Storage of Liquid, Food Waste, or Dangerous Waste Containers
- S429: BMPs for Storage or Transfer (Outside) of Solid Raw Materials, Byproducts, or Finished Products
- S431: BMPs for Washing and Steam Cleaning Vehicles/Equipment/Building Structures
- S449: BMPs for Nurseries and Greenhouses

3.5.1 S427: BMPs for Storage of Liquid, Food Waste, or Dangerous Waste Containers

Description of Pollutant Sources: The BMPs specified below apply to container(s) located outside a building. Use these BMPs when temporarily storing potential pollution generating materials or wastes. These BMPs do not apply when Ecology has permitted the business to store the wastes (see Volume I, Section 2.15 of the Ecology Manual). Leaks and spills of pollutant materials during handling and storage are the primary sources of pollutants. Oil and grease, acid/alkali pH, biochemical oxygen demand (BOD), chemical oxygen demand (COD) are potential pollutant constituents

Pollutant Control Approach: Store containers in impervious containment under a roof or in a building. For storage areas on-site for less than 30 days, consider using a portable temporary secondary system like that shown in Secondary Containment System figure in the Ecology Manual in lieu of a permanent system as described above.

3.4.1-13.5.1.1 Applicable Operational BMPs

- Place tight-fitting lids on all containers.
- Label all containers appropriately. Store containers so that the labels are clearly visible.
- Place drip pans beneath all mounted container taps and at all potential drip and spill locations during filling and unloading of containers.
- Inspect container storage areas regularly for corrosion, structural failure, spills, leaks, overfills, and failure of piping systems. Check containers daily for leaks/spills. Replace containers and replace and tighten bungs in drums as needed.
- Store empty drums containing residues to prevent stormwater from entering drum closures. Cover or tilt drums to prevent stormwater from accumulating on the top of empty drums and around drum closures.
- Store containers that do not contain free liquids in a designated sloped area with the containers elevated or otherwise protected from stormwater run-on. Comply with Title 14 KCC~~local fire code~~.
- Secure drums when stored in an area where unauthorized persons may gain access in a manner that prevents accidental spillage, pilferage, or any unauthorized use (see Locking System for Drum Lid figure in the Ecology Manual).
- If the material is a Dangerous Waste, the business owner must comply with any additional requirements as specified in Volume I, Section 2.15 of the Ecology Manual.
- Storage of reactive, ignitable, and flammable chemicals or materials must comply with the stricter of Title 14 KCC, Title 17 KCC~~local zoning codes, local fire codes~~, the Uniform Fire Code (UFC), UFC standards, or the National Electric Code.
- Have spill kits or cleanup materials near container storage areas.

- Clean up all spills immediately.
- Cover dumpsters to prevent the entry of stormwater. Keep dumpster lids closed.
- Replace or repair leaking garbage dumpsters, or install waterproof liners.
- Drain dumpsters and/or dumpster pads to sanitary sewer.
- When collection trucks directly pick up roll-containers, ensure a filet is on both sides of the curb to facilitate moving the dumpster.

3.4.1-23.5.1.2 Applicable Structural Source Control BMPs

- Keep containers with Dangerous Waste, food waste, or other potential pollutant liquids inside a building unless this is impracticable due to site constraints or International Fire Code requirements.
- Store containers in a designated area, which is covered, bermed or diked, paved and impervious in order to contain leaks and spills (see Figures 3.1 and 3.2). The secondary containment shall be sloped to drain into a dead-end sump for the collection of leaks and small spills.
- For liquid materials, surround the containers with a dike as illustrated in Covered and Bermed Containment Area figure in Volume IV of the Ecology Manual. The dike must be of sufficient height to provide a volume of either 10 percent of the total enclosed container volume or 110 percent of the volume contained in the largest container, whichever is greater.
- Where material is temporarily stored in drums, a containment system can be used as illustrated, in lieu of the above system (see Secondary Containment System figure in Volume IV of the Ecology Manual).
- Place containers mounted for direct removal of a liquid chemical for use by employees inside a containment area as described above. Use a drip pan during liquid transfer (see Mounted Container with Drip Pan figure in Volume IV of the Ecology Manual).

(See separate file for Public Review Draft figures)

Figure 3.1. -Example of a covered, bermed, and plumbed area – plan view

Figure 3.2. Example of a covered, bermed, and plumbed area – side view

3.4.1.33.5.1.3 Applicable Treatment BMP

Note: This treatment BMP is for contaminated stormwater from drum storage areas.

- To discharge contaminated stormwater, pump it from a dead-end sump or catchment and dispose of appropriately.

3.5.2 S429: BMPs for Storage or Transfer (Outside) of Solid Raw Materials, Byproducts, or Finished Products

Description of Pollutant Sources: Some pollutant sources stored outside in large piles, stacks, etc. at commercial or industrial establishments include:

- Solid raw materials
- Byproducts
- Gravel
- Sand
- Salts
- Topsoil
- Compost
- Logs
- Sawdust
- Wood chips
- Lumber
- Concrete
- Metal products

Contact between outside bulk materials and stormwater can cause leachate, and erosion of the stored materials. Contaminants may include TSS, BOD, organics, and dissolved salts (sodium, calcium, and magnesium chloride, etc.).

Pollutant Control Approach: Provide impervious containment with berms, dikes, etc. and/or cover to prevent run-on and discharge of leachate pollutant(s) and TSS.

3.5.2.1 Applicable Operational BMPs

- Do not hose down the contained stockpile area to a storm drain or a conveyance to a storm drain, or to a receiving water.
- Maintain drainage areas in and around storage of solid materials with a minimum slope of 1.5 percent to prevent pooling and minimize leachate formation. Areas should be sloped to drain stormwater to the perimeter for collection or to internal drainage “alleyways” where no stockpiled material exists.
- Sweep paved storage areas regularly for collection and disposal of loose solid materials.
- If and when feasible, collect and recycle water-soluble materials (leachates).

- Stock cleanup materials, such as brooms, dustpans, and vacuum sweepers near the storage area.

3.5.2.2 Applicable Structural BMPs

For stockpiles less than 5 cubic yards, place temporary plastic sheeting (polyethylene, polypropylene, hypalon, or equivalent) over the material (see Material Covered with Plastic Sheeting figure in Volume IV of the Ecology Manual).

The source control BMP options listed below are applicable to:

- Stockpiles greater than 5 cubic yards of erodible or water soluble materials such as:
 - Soil
 - Road deicing salts
 - Compost
 - Unwashed sand and gravel
 - Sawdust
- Outside storage areas for solid materials such as:
 - Logs
 - Bark
 - Lumber
 - Metal products

Choose one or more of the following Source Control BMPs:

- Store in a building or paved and bermed covered area (see Covered Storage Area for Bulk Solids figure in Volume IV of the Ecology Manual).
- Place temporary plastic sheeting (polyethylene, polypropylene, hypalon, or equivalent) over the material (see Material Covered with Plastic Sheeting figure in Volume IV of the Ecology Manual).
- Pave the area and install a drainage system. Place curbs or berms along the perimeter of the area to prevent the run-on of uncontaminated stormwater and to collect and convey runoff to treatment. Slope the paved area in a manner that minimizes the contact between stormwater (e.g., pooling) and leachable materials in compost, logs, bark, wood chips, etc.
- For large uncovered stockpiles, implement containment practices at the perimeter of the site and at any catch basins as needed to prevent erosion and discharge of the stockpiled material off-site or to a storm drain. Ensure that no direct discharge of contaminated stormwater to catch basins exists without conveying runoff through an appropriate treatment BMP.

In addition to the requirements listed above, Kitsap County also requires the following for site access:

- Limit vehicle access and exit to one route, if possible.
- Stabilize access points with a pad of quarry spalls, crushed rock, or other equivalent BMPs, to minimize tracking sediment onto roads. See BMP C105: Stabilized Construction Access in Volume II of the Ecology Manual.
- Locate wheel wash or tire baths on site, if the stabilized entrance is not effective in preventing tracking sediment onto roads. See BMP C106: Wheel Wash in Volume II of the Ecology Manual.
- If sediment is tracked off site, clean the affected roadway thoroughly at the end of each day, or more frequently as necessary (for example, during wet weather). Remove sediment from roads by shoveling, sweeping, or pickup and transport of the sediment to a controlled sediment disposal area.
- Conduct street washing only after sediment removal in accordance with the previous bullet. Control street wash wastewater by pumping back on site or otherwise preventing it from discharging into systems tributary to waters of the State.

3.5.2.3 Applicable Treatment BMPs:

Convey contaminated stormwater from the stockpile area to:

- Wetponds (Volume II, Section 5.4.22),
- Wetvaults, (Volume II, Section 5.4.22),
- Pre-settling Basin (Volume II, Section 5.4.14),
- Manufactured Treatment Device (Volume II, Section 5.4.30), or
- other appropriate treatment system depending on the contamination.

3.5.3 S431: BMPs for Washing and Steam Cleaning Vehicles/Equipment/ Building Structures

Description of Pollutant Sources: Pollutant sources include the commercial cleaning of vehicles, aircraft, vessels, and other transportation, restaurant kitchens, carpets, and industrial equipment, and large buildings with low- or high-pressure water or steam. This includes “charity” car washes at gas stations and commercial parking lots. The cleaning can include hand washing, scrubbing, sanding, etc. Washwater from cleaning activities can contain oil and grease, suspended solids, heavy metals, soluble organics, soaps, and detergents that can contaminate stormwater.

Permitting Requirements: Obtain all necessary permits for installing, altering, or repairing onsite drainage and side sewers. Restrictions on certain types of discharges may require pretreatment before they enter the sanitary sewer.

Pollutant Control Approach: The preferred approach is to cover and/or contain the cleaning activity, or conduct the activity inside a building, to separate the uncontaminated stormwater from the washwater sources. Convey washwater to a sanitary sewer after approval by the local sewer authority. Provide temporary storage before proper disposal, or recycling. Under this preferred approach, no discharge to the ground, to a storm drain, or to surface water should occur.

Facilities not covered under the Industrial Stormwater General Permit that are unable to follow one of the preferred approaches listed above may discharge washwater to the ground only after proper treatment in accordance with Refer to Ecology’s guidance Vehicle and Equipment Washwater Discharges Best Management Practices Manual (Ecology, 2012) for a complete manual on proper vehicle and equipment washing.

The Industrial Stormwater General Permit prohibits the discharge of process wastewater (e.g., vehicle washing wastewater) to ground water or surface water. Stormwater that commingles with process wastewater is considered process wastewater.

Facilities not covered under the Industrial Stormwater General Permit that are unable to follow one of the preferred approaches listed above may discharge washwater to the ground only after proper treatment in accordance with Vehicle and Equipment Washwater Discharges Best Management Practices Manual (Ecology, 2012).

The quality of any discharge to the ground after proper treatment must comply with Ecology’s Ground Water Quality Standards, Chapter 173-200 WAC.

Facilities not covered under the Industrial Stormwater General Permit that are unable to comply with one of the preferred approaches and want to discharge to storm sewer, must meet Kitsap County stormwater requirements. Local authorities may require treatment prior to discharge.

Contact the local Ecology Regional Office to discuss permitting options for discharge of washwater to surface water or to a storm drain after on-site treatment.

3.5.3.1 Applicable Structural Source Control BMPs

Conduct vehicle/equipment washing in one of the following locations:

- At a commercial washing facility in which the washing occurs in an enclosure and drains to the sanitary sewer, or
- In a building constructed specifically for washing of vehicles and equipment, which drains to a sanitary sewer.

Conduct outside washing operations in a designated wash area with the following features:

- In a paved area, construct a spill containment pad to prevent the run-on of stormwater from adjacent areas.
 - Slope the spill containment area to collect washwater in a containment pad drain system with perimeter drains, trench drains or catchment drains.
 - Size the containment pad to extend out a minimum of 4 feet on all sides of the washed vehicles and/or equipment.
- Convey the washwater to a sump (like a grit separator) and then to a sanitary sewer (if allowed by the local Sewer Authority), or other appropriate wastewater treatment or recycle system.
 - The containment sump must have a positive control outlet valve for spill control with live containment volume, and oil/water separation.
 - Size the minimum live storage volume to contain the maximum expected daily washwater flow plus the sludge storage volume below the outlet pipe.
 - Shut the outlet valve during the washing cycle to collect the washwater in the sump.
 - The valve should remain shut for at least 2 hours following the washing operation to allow the oil and solids to separate before discharge to a sanitary sewer.
- Use a two way valve for discharges from the containment pad.
 - This valve should be normally switched to direct water to treatment, but may be switched to the drainage system after that pad is clean to handle stormwater runoff.
 - The stormwater can then drain into the conveyance/discharge system outside of the wash pad (essentially bypassing the sanitary sewer or recycle system).
 - Post signs to inform people of the operation and purpose of the valve.
 - Clean the concrete pad thoroughly until there is no foam or visible sheen in the washwater prior to closing the inlet valve and allowing uncontaminated stormwater to overflow and drain off the pad.

Note: The purpose of the valve is to convey only washwater and contaminated stormwater to a treatment system.

- Collect the washwater from building structures and convey it to appropriate treatment such as a sanitary sewer system if it contains oils, soaps, or detergents. If the washwater does not contain oils, soaps, or detergents (in this case only a low pressure,

clean, cold water rinse is allowed) then it could drain to soils that have sufficient natural attenuation capacity for dust and sediment.

- Sweep surfaces prior to cleaning/washing to remove excess sediment and other pollutants.
- If roof equipment or hood vents are cleaned, ensure that no washwater or process water is discharged to the roof drains or drainage systems.
- Label all mobile cleaning equipment as follows: "Properly dispose of all wastewater. Do not discharge to an inlet/catch basin, ditch, stream, or on the ground."

3.5.3.2 Recommended Additional BMPs

- Mark the wash area at gas stations, multifamily residences and any other business where non-employees wash vehicles.
- Operators may use a manually operated positive control valve for uncovered wash pads, but a pneumatic or electric valve system is preferable.
 - The valve may be on a timer circuit and opened upon completion of a wash cycle.
 - After draining the sump or separator, the timer would then close the valve.
- Minimize the use of water and detergents in washing operations when practicable.
- Use phosphate-free biodegradable detergents when practicable.
- Use the least hazardous cleaning products available.
- Consider recycling the washwater.

Operators may use soluble/emulsifiable detergents in the wash medium and should use it with care and the appropriate treatment. Carefully consider the selection of soaps and detergents and treatment BMPs. Oil/water separators are ineffective in removing emulsified or water soluble detergents. Another treatment appropriate for emulsified and water soluble detergents may be required.

Exceptions:

- At gas stations (for charity car washes) or commercial parking lots, where it is not possible to discharge the washwater to a sanitary sewer, a temporary plug or a temporary sump pump can be used at the storm drain to collect the washwater for off-site disposal such as to a nearby sanitary sewer.
- New and used car dealerships may wash vehicles in the parking stalls as long as employees use a temporary plug system to collect the washwater for disposal as stated above, or an approved treatment system for the washwater is in place.

At industrial sites, contact Ecology for NPDES Permit requirements even when not using soaps, detergents, and/or other chemical cleaners in washing trucks.

3.5.4 S449: BMPs for Nurseries and Greenhouses

Description of Pollutant Sources: These BMPs are for use by commercial container plant, greenhouse grown, and cut foliage production operations. Common practices at nurseries and greenhouses can cause elevated levels of phosphorus, nitrogen, sediment, bacteria, and organic material which can contribute to the degradation of water quality.

Pollutant Control Approach: Minimize the pollutants that leave the site by controlling the placement of materials, stabilizing the site, and managing irrigation water.

3.5.4.1 Applicable Operational BMPs

- Establish nursery composting areas, soil storage, and mixing areas at least 100 feet away from any stream or other surface water body and as far away as possible from drainage systems.
- Do not dispose of collected vegetation into waterways or storm sewer systems.
- Do not blow, sweep, or otherwise allow vegetation or other debris into the drainage system.
- Regularly clean up spilled potting soil to prevent its movement, especially if fertilizers and pesticides are incorporated. (Haver, 2014)
- Use soil mixing and layering techniques with composted organic material to reduce herbicide use and watering.
- Utilize soil incorporated with fertilizers and/or pesticides immediately; do not store for extended periods. (Haver, 2014)
- Cover soil storage and compost storage piles. (See Volume II, Section 3.5.2)
- Dispose of pathogen-laced potting substrate and diseased plants appropriately.
- Place plants on gravel, geotextile, or weed cloth to allow infiltration and minimize erosion, including inside greenhouse structures. (Haver, 2014)
- Properly reuse, recycle, or dispose of used polyfilm, containers, and other plastic-based products so that they do not collect stormwater. (FDACS, 2014)
- Evaluate and manage irrigation to reduce runoff, sediment transport, and erosion.
 - Place irrigation inputs to keep moisture primarily in the plant's root zone. This will significantly reduce nutrient related impacts from fertilizers. (FDACS, 2014)
 - Avoid over-irrigating. This may exceed the soil's water-holding capacity and lead to runoff or leaching. (FDACS, 2014)
 - Consider and adjust as needed the uniformity of application, the amount of water retained within the potting substrate, and the amount of water that enters containers compared to that which exits the containers and / or falls between containers. (FDACS, 2014)

- Consolidate containers and turn off irrigation in areas not in production. This may require individual on / off valves at each sprinkler head. (Haver, 2014)
- Based on the stage of plant growth, space containers and flats as close as possible to minimize the amount of irrigation water that falls between containers. (FDACS, 2014)
- Group plants of similar irrigation needs together. (FDACS, 2014)
- Consider minimizing water losses by using cyclic irrigation (multiple applications of small amounts). (FDACS, 2014)
- Consider using sub-irrigation systems (e.g. capillary mat, ebb-and-flow benches, and trays or benches with liners); these systems can conserve water and reduce nutrient loss, particularly when nutrients are supplied in irrigation water that is reused. (FDACS, 2014)
- See S450 BMPs for Irrigation in Volume IV of the Ecology Manual for additional BMP considerations.
- See S443 BMPs for Fertilizer Application and S435 BMPs for Pesticides and an Integrated Pest Management Program in Volume IV of the Ecology Manual.

3.5.4.2 Applicable Structural BMPs

- Use windbreaks or other means (e.g. pot in pot) to minimize plant blowover. (FDACS, 2014)
- Cover potting areas with a permanent structure to minimize movement of loose soil. Use a temporary structure if a permanent structure is not feasible. (Haver, 2014)
- Control runoff from central potting locations that have a watering station used to irrigate plants immediately after potting. Either:
 - Collect runoff in a small basin and reuse the runoff.
 - Or, route runoff through an onsite vegetative treatment area.
 - Or, use a graveled area and allow runoff to infiltrate.
- Surround soil storage and compost storage areas with a berm or wattles.
- Utilize a synthetic (geotextile) groundcover material to stabilize disturbed areas and prevent erosion in areas where vegetative cover is not an option. (FDACS, 2014)
- In areas with a large amount of foot traffic, use appropriate aggregate such as rock and gravel for stabilization. (FDACS, 2014)
- Store potting substrate that contains fertilizer in a dedicated area with an impermeable base. If the storage area is not under a roof to protect it from rainfall, manage runoff by directing it to a stormwater treatment area. (FDACS, 2014)

In addition to the requirements listed above, Kitsap County also requires the following for site access:

- Limit vehicle access and exit to one route, if possible.
- Stabilize access points with a pad of quarry spalls, crushed rock, or other equivalent BMPs, to minimize tracking sediment onto roads. See BMP C105: Stabilized Construction Access in Volume II of the Ecology Manual.
- Locate wheel wash or tire baths on site, if the stabilized entrance is not effective in preventing tracking sediment onto roads. See BMP C106: Wheel Wash in Volume II of the Ecology Manual.
- If sediment is tracked off site, clean the affected roadway thoroughly at the end of each day, or more frequently as necessary (for example, during wet weather). Remove sediment from roads by shoveling, sweeping, or pickup and transport of the sediment to a controlled sediment disposal area.
- Conduct street washing only after sediment removal in accordance with the previous bullet. Control street wash wastewater by pumping back on site or otherwise preventing it from discharging into systems tributary to waters of the State.

CHAPTER 4 CONVEYANCE SYSTEM ANALYSIS & DESIGN

4.1 Introduction

This chapter presents approved methods for the hydraulic analysis and design of conveyance systems. A conveyance system includes all portions of the surface water system, either natural or man-made, that transport surface [water](#) and ~~stormwater~~ [storm-water](#) runoff.

Design criteria, methods of analysis, and standard details for all components of the conveyance system are detailed [in the following sections below](#). In some cases, reference is made to other adopted or accepted design standards and criteria such as the [WSDOT/APWA Standard Specifications for Road, Bridge, and Municipal Construction](#) (most recent edition).

4.2 Conveyance System Design Flow

All conveyance systems shall be designed, at a minimum, to convey a peak [design flow](#) ~~stormwater~~ rate resulting from a 100-year frequency storm event, with the following exceptions:

1. Other governing authorities may require that the design of some structures be based on a larger storm event.
2. Some [runoff treatment BMP](#) ~~water quality facilities~~ are designed to function primarily under low flow conditions. Unless higher flows are diverted from these [runoff treatment BMP](#) ~~water quality facilities~~ per [Volume II](#), Section 4.8.1, they shall also be designed to have sufficient conveyance capacity for 100-year storm flow rates.

For all existing and proposed conveyance systems receiving drainage from a contributing area of 25 acres or less and having a time of concentration of 100 minutes or less, the Rational Method ([Volume II, Section 4.2.1](#)) may be used ~~as described in this chapter~~. For all other conditions, either the Santa Barbara Urban Hydrograph Model (SBUH), [Western Washington Hydrology Model \(WWHM\)](#), or ~~MGS Flood~~ [MGS Flood Model](#) shall be used. For public road projects, design flows may be determined using the hydrologic modeling procedures in the [WSDOT Highway Runoff Manual](#) or the procedures [outlined in this section below](#).

4.2.1 Rational Method

The traditional Rational Method, as described in most engineering manuals, is preferred by Kitsap County for designing systems serving smaller contributing basins primarily because it tends to provide higher runoff [flow](#) rates than hydrograph methods do, resulting in a more conservative design with a built-in factor of safety. ~~A~~ [M](#)odeling guidance for the [R](#)ational [M](#)ethod is provided in Appendix F.

4.2.2 Santa Barbara Urban Hydrograph Method

Calculations shall be conducted in accordance with the instructions found in [Volume III of the Ecology Manual](#). **Modeling shall be performed using a 10-minute time step.**

4.2.3 Western Washington Hydrology Model (WWHM)

The Western Washington Hydrology Model (WWHM) (latest approved version) is an approved continuous simulation model. See Chapter 5 of ~~this manual~~ and [Volume III, Chapter 2 of the Ecology Manual](#) for a description of how to use WWHM. **Modeling shall be performed using a 15-minute time step.**

4.2.4 ~~MGSFlood~~MGS Flood Model

~~MGSFlood~~The MGS Flood Model is also an approved continuous simulation model. [As of the publication of this manual, MGSFlood Version 4.49 had limited approval status and was not approved by Ecology for modeling bioretention. Refer to Ecology's Approval Status of Continuous Simulation Models web page for updates related to the approval status of MGSFlood.](#) Consult with the ~~MGSFlood~~model user manual for a complete description of how to use ~~the model~~. **Modeling shall be performed using a 15-minute time step.**

4.3 Route Design and Easement Requirements

This section presents the general requirements for conveyance system route design, allowable discharge types and locations, and providing easements and setbacks to allow for proper maintenance and inspection of all conveyance system elements.

A vertical datum shall be used in the design of all public drainage systems or systems that will be owned or operated by Kitsap County or that connect to a [Kitsap](#) County system. All datum shall be either NGVD29 or NAVD88.

4.3.1 Route Design

The most efficient route selected for new conveyance systems will result from careful consideration of the topography of the area to be traversed, existing trees or landscaping to be preserved, the legal property boundaries, and access for inspection and maintenance. The general requirements for route design are as follows:

1. [Align p](#)Proposed new conveyance systems ~~should be aligned~~ to emulate the natural conveyance system to the extent feasible. [Place i](#)nflows to the system and discharge from the system ~~should occur~~ at the natural drainage points as determined by topography and existing drainage patterns.
2. [Locate n](#)New conveyance system alignments in residential subdivisions ~~should be located~~ adjacent and parallel to property lines so that required drainage easements can be situated along property lines. [Locate d](#)rainage easements ~~should be located~~ entirely on one property and not split between adjacent properties. *Exception:* Streams and natural drainage channels shall not be relocated to meet this requirement.

Apply the site assessment and planning principals detailed in Volume I, Chapter 2 ~~of this manual~~ to route design for conveyance facilities.

4.3.2 Discharge Type and Location

Where no conveyance system exists at the abutting downstream property line and the natural (existing) discharge is unconcentrated, any runoff concentrated by the proposed project shall be discharged as follows:

1. If the 100-year peak discharge is less than or equal to 0.2 cubic feet per second (cfs) (0.3 cfs if using an approved continuous runoff model using 15-minute time steps) under existing conditions and will remain less than or equal to 0.2 cfs under developed conditions, then the concentrated runoff may be discharged onto outlet protection with riprap-rock pad or to any another system that serves to disperse flows.
2. If the 100-year peak discharge is less than or equal to 0.5 cfs under existing conditions and will remain less than or equal to 0.5 cfs under developed conditions, then the concentrated runoff may be discharged through a dispersiondispersal trench (see Figure 4.1) or other dispersal-dispersion system (see Figure 4.2), provided the applicant can demonstrate that there will be no significant adverse impact to downhill properties or drainage systems.
3. If the 100-year peak discharge is greater than 0.5 cfs for either existing or developed conditions, or if a significant adverse impact to downgradient properties or drainage systems is likely, then a conveyance system shall be provided to convey the concentrated runoff across the downstream properties to an acceptable discharge point location (i.e., an enclosed drainage system or open drainage feature where concentrated runoff can be discharged without significant adverse impact).

(See separate file for Public Review Draft figures)

Figure 4-1. ~~Flow-Dispersion~~Dispersal Trench.

Figure 4-2. ~~Alternative Dispersion~~Flow-Dispersal Trench.

4.3.3 Easement and Setback Requirements

Proposed projects shall comply with the following easement and setback requirements unless otherwise approved by the director:

1. Any on-site conveyance system element constructed as part of a subdivision project shall be located in a dedicated drainage easement, tract, or right-of-wayright of way that preserves the system's route and conveyance capacity and grants Kitsap County right of access for inspection, maintenance, and repair. Exception: Roof downspout, minor yard, and footing drains do not require easements, tracts, or right-of-wayright of way. If easements are provided for these minor drains (or for other utilities such as power, gas, or telephone), they need not comply with the requirements of this section.

2. Except for those facilities that have been formally accepted for maintenance by Kitsap County, maintenance and repair of drainage facilities [and BMPs](#) on private property shall be the responsibility of the property owner.
3. Any on-site conveyance system element constructed as part of a commercial building permit or commercial development permit shall be covered by the drainage facility declaration of covenant and grant of easement that provides Kitsap County right of access for inspection, maintenance, and repair. Note: except for those facilities that have been formally accepted for maintenance by Kitsap County, maintenance and repair of drainage facilities [and BMPs](#) on private property shall be the responsibility of the property owner.
4. Any off-site conveyance system element constructed through private property as part of a proposed project shall be located in a drainage easement.
5. All drainage easements, public and private, shall meet the following standards:
 - a. All drainage easements shall have a minimum width of 15 feet, with the exception that easements for private roof and yard drain systems may have a minimum width of 10 feet.
 - b. All 5-foot-diameter and smaller pipes shall be located within the easement so that each pipe face is no closer than 5 feet from each easement boundary.
 - c. All 5-foot-wide and smaller open channels shall be located within the easement so that the water surface elevation at the top of freeboard is no closer than 5 feet from each easement boundary.
 - d. Roof and yard drain pipes shall be centered in the easement.
 - e. For pipes larger than 5 feet in diameter and for channels having a top width at freeboard wider than 5 feet, the easement width shall be larger than the minimum 15-foot width, sized to meet the required setbacks from the easement boundaries.
6. Maintenance access shall be provided for all manholes, catch basins, vaults, or other drainage facilities that are to be maintained by Kitsap County. It is not generally necessary to provide vehicular access along the entire length of a drainage pipe or swale as long as access is provided at each end. Maintenance access shall consist of an access easement and a constructed access road, with turn-around if necessary. Access roads shall be constructed as specified in Volume II, Chapter 5—[BMP Design](#).

4.4 Pipes, Outfalls, and Pumps

This section presents the design criteria for analysis and design of pipe systems, outfalls, and pump-dependent conveyance systems.

4.4.1 Pipe Systems

Pipe systems are networks of storm drain pipes, catch basins, manholes, inlets, and outfalls designed and constructed to convey surface water, including stormwater runoff. The hydraulic analysis of flow in storm drain pipes typically is limited to gravity flow; however, in analyzing existing systems it may be necessary to address pressurized conditions. A properly designed pipe system will maximize hydraulic efficiency by utilizing proper material, slope, and pipe size.

4.4.1.1 Design Criteria

All pipe material, joints, protective treatment, and construction workmanship shall be in accordance with *WSDOT/APWA Standard Specifications*, and AASHTO and ASTM treatment as noted ~~below~~ under "Allowable Pipe Materials."

The pipe materials and specifications included in this section are for conveyance systems installed according to engineering plans required for Kitsap County permit approval. Other pipe materials and specifications may be used by private property owners for drainage systems they construct and maintain when such systems are not required by or granted to Kitsap County.

Allowable Pipe Sizes

See Table 4.1 for allowable pipe sizes for pipe systems to be maintained by Kitsap County. For special cases where written approval is provided by the County Road Engineer, 8-inch diameter pipes may be allowed within the roadway ~~right-of-way~~right of way. Eight (8)-inch diameter pipe may also be allowed for privately maintained systems.

Allowable Pipe Materials

The following pipe materials are allowed for use in meeting the requirements of this manual. ~~See~~Refer to [WSDOT/APWA Standard Specifications for Road, Bridge, and Municipal Construction](#) 7-02, 7-03 and 7-04 for detailed specifications for acceptable pipe materials.

1. Plain and reinforced concrete pipe.
2. Corrugated or spiral rib aluminum pipe.
3. Ductile iron (water supply, Class 50 or 52).
4. ~~Lined C~~orrugated polyethylene (~~LCPE~~) pipe (CPEP)¹.
5. Polyvinyl chloride (PVC)² pipe.
6. Solid wall polyethylene (SWPE; also known as high-density polyethylene [HDPE] pipe or high-density polyethylene pipe [HDPP]) pipe³.

¹ ~~CPEP~~CPEP pipe and fittings shall be manufactured from high density polyethylene resin which shall meet or exceed the requirements of Type 111, Category 3, 4 or 5, Grade P23, P33 or P34, Class C per ASTM D3350. In addition, the pipe must be lined and shall comply with all material and stiffness requirements of AASHTO M294.

² PVC pipe is allowed only for use in privately maintained drainage systems. PVC pipe shall be SDR 35 or thicker and meet the requirements of ASTM D3034.

³ SWPE pipe is normally used outside of Kitsap County ~~right-of-way~~right of way, such as on steep

Allowable Pipe Joints

1. Concrete pipe shall be rubber gasketed.
2. [Corrugated metal pipe \(CMP\)](#) shall be rubber gasketed and securely banded.
3. Spiral rib pipe shall be "hat-banded" with neoprene gaskets.
4. Ductile pipe joints shall be flanged, bell and spigot, or restrained mechanical joints.
5. ~~CPEL~~[CPE pipe](#) joints shall conform to the current [WSDOT/APWA Standard Specifications for Road, Bridge, and Municipal Construction](#).
6. PVC pipe shall be installed following procedures outlined in ASTM D2321; joints shall conform to ASTM D3212, and gaskets shall conform to ASTM F477.
7. SWPE pipe shall be jointed by butt fusion methods or flanged.

Pipe Alignment

1. Pipes shall be laid true to line and grade with no curves, bends, or deflections in any direction. Exception: Vertical deflections in SWPE and ductile iron pipe with flanged restrained mechanical joint bends (not greater than 30°) may be allowed on steep slopes, provided the pipe drains.
2. A break in grade or alignment, or changes in pipe material shall occur only at catch basins or manholes.

Changes in Pipe Size

The following criteria apply to changes in conveyance pipe sizes (not including detention tanks):

1. Increases or decreases in pipe size are allowed only at junctions and structures.
2. When connecting pipes at structures, match any of the following (in descending order of preference): crowns, 80% diameters,⁴ or inverts of pipes. Side lateral connections⁵ 12-inches and smaller are exempt from this requirement.
3. Drop manholes may be used for energy dissipation when pipe velocities exceed 10 feet per second (fps). External drop manholes are preferred where maintenance access to the upstream pipe is preserved by use of a tee section. Internal drop structures may be

slope installations. Connections to Kitsap County road drainage systems are allowed for pipe diameters of 12" or greater. SWPE pipe shall comply with the requirements of Type III C5P34 as tabulated in ASTM D1248, shall have the PPI recommended designation of PE3408, and shall have an ASTM D3350 cell classification of 345534C. The pipe shall have a manufacturer's recommended hydrostatic design stress rating of 800 psi based on a material with a 1600 psi design basis determined in accordance with ASTM D2837-69. The pipe shall have a suggested design working pressure of 50 psi at 73.4° F and SDR of 32.5.

⁴ Match point is at 80% of the pipe diameter, measured from the invert of the respective pipes.

⁵ Side laterals include any 8-inch or smaller pipe connected to the main conveyance system at a catch basin, or manhole, as allowed under this manual. In addition, 12-inch and smaller pipes that serve a single inlet point (e.g., roadway simple inlets, footing drains, and lot stubouts including manifold systems serving multiple residential lots) are also included. Excluded from this definition are inlet pipes which contribute 30% or more of the total flow into a catch basin, or which collect or convey flows from a continuous source.

approved only if adequate scour protection is provided for the manhole walls. Drop structures shall be individually engineered to account for design variations, such as flow rates, velocities, scour potential, and tipping forces.

- Downsizing pipes larger than 12 inches may be allowed provided pipe capacity is adequate for design flows.

Structures

Table 4.1 lists typical drainage structures with corresponding maximum allowable pipe sizes.

- Catch basin (or manhole) diameter shall be determined by pipe orientation at the junction structure. A plan view of the junction structure, drawn to scale, will be required for submittal with the site improvement plans (Volume II, Chapter 1 [of this manual](#)) when more than four pipes enter the structure on the same plane, or if angles of approach and clearance between pipes is of concern. The plan view (and any sections if necessary) shall ensure a minimum distance between pipe openings of 8 inches for 48-inch and 54-inch catch basins, and 12 inches for 72-inch and 96-inch catch basins. The minimum distance between pipe openings shall be of solid concrete wall.
- Evaluation of the structural integrity for H-20 loading, or as required by the *Kitsap County Road Standards* ([latest edition](#)), may be required for multiple junction catch basins and other structures.
- Catch basins shall be provided within 50 feet of the entrance to a pipe system to provide for silt and debris removal.
- All SWPE pipe systems (including buried SWPE pipe) shall be secured at the upstream end. Where connecting to a structure, the downstream end shall be placed in a 4-foot section of the next larger pipe size. This sliding sleeve connection allows for the high thermal expansion/contraction coefficient of this pipe material.
- [Through-curb inlets \(see Figure 4.3\) are required on all catch basins located at roadway sags and in low points of cul-de-sacs.](#)
- The maximum slope of the ground surface for a radius of 5 feet around a catch basin grate or solid lid should be 5 horizontal to 1 vertical (5H:1V) to facilitate maintenance access. Where not physically feasible, a maximum slope of 3H:1V shall be provided around at least 50% of the catch basin circumference.

Table 4.1. Allowable Structures and Pipe Sizes

Catch Basin Type	Maximum Pipe Diameter	
	CMP, Spiral Rib, SWPE, PVC and Ductile Iron ^a	Concrete, CPEPLCPE
Inlet ^b	12"	12"
Type 1 ^b	18"	12"
Type 1L ^b	24"	18"
Type 2 – 48" diameter	30"	24"

Type 2 – 54” diameter	36”	30”
Type 2 – 72” diameter	54”	48”
Type 2 – 96” diameter	72”	72”

Notes:

- a. Generally, these pipe materials will be one size larger than concrete due to smaller wall thickness. However, for angled connections or those with several pipe on the same plane, this will not apply.
- b. A maximum of 5 vertical feet is allowed between finished grade and invert lowest elevation.

Figure 4.3. Through-Curb Inlet

Pipe Design between Structures

1. Minimum velocity at full flow shall be 3 feet per second (fps). If site constraints result in velocities less than 3 fps at full flow, impacts from sedimentation in the pipe system shall be addressed with larger pipes, closer spacing of structures, sediment basins, or other similar measures.
2. Maximum velocity: 30 fps, except that there is no maximum velocity requirement for ductile iron pipe or butt welded SWPE.
3. Minimum slope for installed stormwater pipes shall be 0.50%.
4. SWPE tightlines down steep slopes are self- cleaning and do not require structures for maintenance.
5. The following maximum inlet spacings are recommended:
 - a. For roadway slopes less than 1%, maximum inlet spacing shall be 150 feet or less.
 - b. For roadway slopes from 1% to 3%, maximum inlet spacing shall be 200 feet or less.
 - c. For roadway slopes greater than 3% or design flows greater than 3 fps, maximum inlet spacing shall be 300 feet.
 - d. For structures with solid lids, the maximum spacing shall be 300 feet.
 - e. The maximum design water surface elevation in inlet structures shall be 1 foot below the top of the structure.

Pipe Cover

1. Pipe cover, measured from the finished grade elevation to the top of the outside surface of the pipe, shall be 2-foot minimum unless otherwise specified or allowed below. Under drainage easements, driveways, parking stalls, or other areas subject to light vehicular loading, pipe cover may be reduced to 1-foot minimum if the design considers expected vehicular loading and the cover is consistent with pipe manufacturer's recommendations. Pipe cover in areas not subject to vehicular loads, such as landscape planters and yards, may be reduced to 1-foot minimum.

2. Pipe cover over concrete pipe shall comply with Table 4.2. For other pipe types, the manufacturer's specifications or other documentation shall be provided for proposed cover in excess of 30 feet. *Caution:* Additional precautions to protect against crushing during construction may be needed under roadways if the [road-bed/roadbed](#) is included to meet minimum cover requirements. Damaged pipe shall be replaced.
3. For proposed pipe arches, the manufacturer's specifications or other documentation shall be provided for proposed cover.

Table 4.2.—Maximum Cover (feet) for Concrete Pipe-Compaction Design A

Pipe Diameter (inches)	Plain	Class II	Class III	Class IV	Class V
12"	18	10	14	21	26
18"	18	11	14	22	28
24"	16	11	15	22	28
30"		11	15	23	29
36"		11	15	23	29
48"		12	15	23	29
60"		12	16	24	30
72"		12	16	24	30
84"		12	16	24	30
96"		12	16	24	30
108"		12	16	24	30

Note:

Compaction Design A refers to [the WSDOT Standard Plan for Pipe Bedding \(B-55.20-02\)](#) [Figure 4-2](#)

Pipe Clearances

A minimum of 6 inches vertical and 3 feet horizontal clearance (outside surfaces) shall be provided between storm drain pipes and other utility pipes and conduits. When crossing sanitary sewer lines, the Washington [State](#) Department of Ecology criteria shall apply.

Pipe Compaction and Backfill

Pipe compaction and backfill shall be in accordance with [Figure 4.2](#) [the WSDOT Standard Plan for Pipe Bedding \(B-55.20-02\)](#).

Pipe System Connections

Connections to a pipe system shall be made only at catch basins or manholes. No wyes or tees are allowed except on roof/footing/yard drain systems on pipes 8 inches in diameter or less, with clean-outs upstream of each wye or tee. Additional exceptions may be made for steep slope applications of SWPE pipe, as deemed prudent by geotechnical review.

Pipe Anchors

Table 4.3 presents the requirements, by pipe material, for anchoring pipe systems, and Figure 4.4 and Figure 4.5 show typical details of pipe anchors.

Table 4.3. Maximum Pipe Slopes and Velocities

Pipe Material	Pipe Slope Above Which Pipe Anchors Required and Minimum Anchor Spacing	Maximum Slope Allowed	Maximum Velocity at Full Flow
CMP, Spiral Rib, PVC	20% - (1 anchor per 100 LF of pipe)	30% ^c	30 fps
Concrete or CPEPLGPE ^a	10% - (1 anchor per 50 LF of pipe)	20% ^c	30 fps
Ductile Iron ^b	20% - (1 anchor per pipe section)	None	None
SWPE ^b	20% - (1 anchor per 100LF of pipe, cross-slope installation only)	None	None

Notes:

- These materials are not allowed in Geologically Hazardous Areas as defined in [Title 19 KCC](#).
- Butt-fused or flanged pipe joints are required; above ground installation is recommended on slopes greater than 40%.
- Maximum slope of 200% is allowed for ~~these pipe materials~~ [materials](#) with no joints (one section), with structures at each end, and with proper grouting.

[Figure 4.4. Pipe Anchor Detail](#)

[Figure 4.5. Corrugated Metal Pipe Coupling and/or General Pipe Anchor Assembly](#)

Debris Barriers

Debris barriers (trash racks) are required on all pipes 18 to 36 inches in diameter entering a closed pipe system. Debris barriers shall have a bar spacing of 6 inches. ~~Refer to Figure 4.5 for required debris barriers on pipe ends outside of roadways.~~ Refer to [Figure 4.6](#) ~~Figure 4.6 and Volume II, Section 4.5 for debris barrier requirements, on pipe ends (culverts) projecting from driveway or roadway side slopes.~~

[Figure 4.6. Debris Barrier \(In Road Right-of-Way\)](#)

Outfalls

Outfalls shall be designed as detailed in [Volume II, Section 4.4.2](#) ~~below~~.

Other Details

In addition to the details shown in Figure 4.1 through Figure 4.6, standard construction details are available in the [APWA/WSDOT Standard Plans for Road, Bridge and Municipal Construction](#).

4.4.1.2 Methods of Analysis

This section presents the methods of analysis for designing new or evaluating existing pipe systems for compliance with the conveyance system capacity requirements.

Design flows

Design flows for sizing or assessing the capacity of pipe systems shall be determined using the hydrologic analysis methods described in [Volume II, Section 4.2-~~above~~](#).

Inlet grate capacity

The methods described in [Chapter 5, Sections 4 and 5](#), of the [WSDOT Hydraulics Manual](#) may be used in determining the capacity of inlet grates when capacity is of concern, with the following exceptions:

1. Use 100-year design flows as computed per [Volume II, Section 4.2-~~above~~](#).
2. Assume grate areas on slopes are 80% free of debris; "vaned" grates, 95% free.
3. Assume grate areas in sags or low spots are 50% free of debris; "vaned" grates, 75% free.

Conveyance capacity

Two methods of hydraulic analysis using Manning's equation are used sequentially for the design and analysis of pipe systems. First, the Uniform Flow Analysis method is used for the preliminary design of new pipe systems. Second, the Backwater Analysis method is used to analyze both proposed and existing pipe systems to verify adequate capacity. Each method is described further in Appendix F.

Note: Use of the Uniform Flow Analysis method to determine preliminary pipe sizes is only suggested as a first step in the design process and is not required. Results of the Backwater Analysis method determine final pipe sizes in all cases. The director has the authority to waive the requirement for backwater analysis as verification.

4.4.2 Outfall Systems

Properly designed outfalls are critical to reducing or eliminating adverse impacts, both on-site and downstream, as a result of concentrated discharges from pipe systems and culverts. Outfall systems include rock splash pads, flow ~~dispersion~~[dispersal](#) trenches, gabion or other energy dissipaters, and tightline systems. A tightline system is typically a continuous length of pipe used to convey flows down a steep or sensitive slope with appropriate energy dissipation at the discharge end. In general, it is recommended that conveyance systems be designed to reduce velocity above outfalls to the extent feasible. [Design criteria for outfall features and tightline systems are described in Volume II, Section 4.4.2.1 and Volume II, Section 4.4.2.2.](#)

4.4.2.1 ~~Outfall Features~~[Design Criteria](#)

At a minimum, all outfalls shall be provided with a rock splash pad, [unless the site requires a more robust energy dissipator](#). [See the following bullets for guidance on outfall features, including other types of energy dissipation and appropriate uses for each, except as specified below and in Table 4.4:](#)

1. The flow ~~dispersal~~[dispersion](#) trenches [es](#) shown in Figure 4.1 [and Figure 4.2](#) shall only be used as an outfall.

2. For outfalls with a velocity at design flow greater than 10 fps, a gabion dissipater or engineered energy dissipater shall be required. [There are many possible designs.](#)

Note: The gabion outfall detail shown in Figure 4.7 is illustrative only; ~~a~~ design engineered to specific site conditions ~~is required~~ must be developed. Gabions shall conform to [APWA/WSDOT Standard Plans for Road, Bridge and Municipal Construction](#) ~~WDSOT/APWA specifications.~~

3. Engineered energy dissipaters, including stilling basins, drop pools, hydraulic jump basins, baffled aprons, and bucket aprons, are required for outfalls with [design](#) velocity ~~at design flow~~ greater than 20 fps. [Design energy dissipaters](#) ~~These should be designed~~ using published or commonly known techniques found in ~~such~~ references [such as the Hydraulic Design of Energy Dissipaters for Culverts and Channels, \(FHWA 2006\)](#) ~~published by the Federal Highway Administration of the United States Department of Transportation;~~ [Open Channel Hydraulics Flow, by V.T. \(Chow 1959\); Hydraulic Design of Stilling Basins and Energy Dissipaters, EM 25, Bureau of Reclamation \(Peterka 1984/1978\);](#) and other publications, such as those prepared by the Soil Conservation Service (now Natural Resource Conservation Service).

4. Alternate mechanisms [may be used](#), such as bubble-up structures ~~that (which will eventually drain)~~ and structures fitted with reinforced concrete posts; [If alternative mechanisms are considered, they](#) require an individual approval and shall be designed using sound hydraulic principles and considering constructability and ease of [construction and](#) maintenance.

- 1.5. ~~Caution: One caution to note is that t~~ [The in-stream sample](#) ~~example~~ gabion ~~mattress energy dissipater~~ outfall (Figure 4.7 ~~Figure 4.7~~) may not be acceptable within the ordinary high water mark of fish-bearing waters or where gabions will be subject to abrasion from upstream channel sediments. [Consider using a](#) four-sided gabion basket located outside the ordinary high water mark ~~should be considered~~ for these applications.

Figure 4.7. Gabion Mattress Dissipater Detail

4.4.2.2 Tightline Systems

1. ~~Outfall tightline systems shall be designed as follows:~~
 1. Outfall tightlines may be installed in trenches with standard bedding on slopes up to 40%. In order to minimize disturbance to slopes greater than 40%, it is recommended that tightlines be placed at grade with proper pipe anchorage and support. At-grade tightlines shall be SWPE.
 2. Outfall SWPE tightlines shall be designed to address the material limitations, particularly thermal expansion and contraction and pressure design, as specified by the manufacturer. The coefficient of thermal expansion and contraction for SWPE is on the order of 0.001 inch per foot per [degree](#) Fahrenheit ~~degree~~. Sliding sleeve connections shall be used to address this thermal expansion and contraction. These sleeve connections consist of a section of the appropriate length of the next larger size diameter of pipe into which the

outfall pipe is fitted. These sleeve connections shall be located as close to the discharge end of the outfall system as is practical.

3. Outfall SWPE tightlines shall be designed and sized using the applicable design criteria and methods of analysis specified for pipe systems in [Volume II](#), Section 4.4.1.
4. Due to the ability of outfall SWPE tightlines to transmit flows of very high energy, special consideration for energy dissipation shall be made. Details of an [example sample](#) "gabion [outfall mattress energy dissipater](#)" are provided as [Figure 4.7](#). Details of a sample "tee type dissipater" are provided as [Figure 4.8](#).

[Figure 4.8](#) Tee Type Energy Dissipater

4.4.3 Pump Systems

Pump systems may be used [to convey water from one location or elevation to another within for conveyance of flows internal to](#) a site if [they are](#) located on private property and [will be](#) privately maintained.

4.4.3.1 Design Criteria

Proposed pump systems shall meet the following minimum requirements:

1. The pump system shall be privately owned and maintained.
2. The pump system shall be used to convey water from one location or elevation to another within the site.
3. The pump system shall have a dual pump (alternating) equipped with an external alarm system.
4. The pump system shall not be used to circumvent any other Kitsap County drainage requirements ([Title 12 KCC](#)), and construction and operation of the pump system shall not violate any other Kitsap County requirements.
5. The gravity-flow components of the drainage system to and from the pump system shall be designed so that pump failure does not result in flooding of a building or emergency access, or overflow to a location other than the natural discharge [point location](#) for the site.

4.4.3.2 Methods of Analysis

Pump systems shall be sized to convey the anticipated [on-site stormwater](#) peak flow rates up to the 100-year recurrence interval.

4.5 Culverts

Culverts are relatively short segments of pipe of circular, elliptical, rectangular, or arch cross section. They are usually placed under road embankments or driveways to convey surface water flow safely under the embankment. They may be used to convey flow from constructed or natural channels including streams.

This section presents the methods, criteria, and overview for hydraulic analysis and design of culverts. See Appendix F for details on the methods and standards to be used for hydraulic analysis and design.

4.5.1 Design Criteria

1) General

- a. All circular pipe culverts shall conform to any applicable design criteria specified for pipe systems in [Volume II](#), Section 4.4.1.
- b. All other types of culverts shall conform to manufacturer's specifications.
- c. Minimum culvert diameters are as follows:
 - i) For cross-culverts under public and private roadways, minimum 18-inch-diameter shall be used.
 - ii) For all other roadway culverts, including driveway culverts, minimum 12-inch-diameter shall be used.
- d. No bends shall be permitted in culvert pipes.
- e. Minimum cover over culverts shall be 2 feet under primary roads, 1 foot under secondary roads and in all roadside applications and on private property.
- f. Maximum culvert length shall be 300 feet.

2) Headwater

- a. For culverts 18-inch diameter or less, the maximum allowable headwater elevation (measured from the inlet invert) shall not exceed 2 times the pipe diameter or arch-culvert-rise at design flow
- b. For culverts larger than 18-inch diameter, the maximum allowable design flow headwater elevation (measured from the inlet invert) shall not exceed 1.5 times the pipe diameter or arch-culvert-rise at design flow.
- c. The maximum headwater elevation at design flow shall be at least 1 foot below any road or parking lot subgrade.

3) Inlets and Outlets

- a. All inlets and outlets in or near roadway embankments shall be flush with and conforming to the slope of the embankment.
- b. For culverts 18-inch-diameter and larger, the embankment around the culvert inlet shall be protected from erosion by rock lining or riprap as specified in Table 4.4, except the length shall extend at least 5 feet upstream of the culvert, and the height shall be at or above the design headwater elevation. See Figure 4.9 for a pipe culvert discharge protection detail.

c. Inlet structures, such as concrete headwalls, may provide a more economical design by allowing the use of smaller entrance coefficients and, hence, smaller diameter culverts. When properly designed, they will also protect the embankment from erosion and eliminate the need for rock lining.

d. Concrete headwalls are required for all CPEP, SWPE, and PVC pipe systems having exposed ends (see Figure 4.10).

e. In order to maintain the stability of roadway embankments, concrete headwalls, wingwalls, or tapered inlets and outlets may be required if right-of-way or easement constraints prohibit the culvert from extending to the toe of the embankment slopes. All inlet structures or headwalls installed in or near roadway embankments shall be flush with and conforming to the slope of the embankment.

f. Debris barriers (trash racks) are required on the inlets of all culverts that are over 60 feet in length and are 18 to 36 inches in diameter. Debris barriers shall have a bar spacing of 6 inches. This requirement also applies to the inlets of pipe systems. See Figure 4.6 and Figure 4.7 for debris barrier details.

g. For culverts 18-inch diameter and larger, the receiving channel of the outlet shall be protected from erosion by rock lining specified in Table 4.4, except the height shall be one foot above maximum tailwater elevation or one foot above the crown, whichever is higher.

Figure 4.9. Pipe Culvert Discharge Protection

Figure 4.10. Concrete End Protection

Table 4.4. Rock Protection at Outfalls

Discharge Velocity at Design Flow (fps)		Required Protection				
Greater than	Less than or equal to	Minimum Dimensions ^a				
		Type	Thickness	Width	Length	Height
0	5	Rock lining ^b	1 foot	Diameter + 6 feet	8 feet or 4x diameter, whichever is greater	Crown + 1 foot
5	10	Riprap ^{c,d}	2 feet	Diameter + 6 feet or 3x diameter, whichever is greater	12 feet or 4x diameter, whichever is greater	Crown + 1 foot
10	20	Gabion Outfall	As required	As required	As required	Crown + 1 foot

Discharge Velocity at Design Flow (fps)		Required Protection				
Greater than	Less than or equal to	Minimum Dimensions ^a				
		Type	Thickness	Width	Length	Height
20	N/A	Engineered energy dissipater required				

Notes:

- a. These sizes assume that erosion is dominated by outfall energy. In many cases sizing will be governed by conditions in the receiving waters.
- b. Rock lining shall be quarry spalls with gradation as follows:
 - Passing 8-inch square sieve: 100%
 - Passing 3-inch square sieve: 40 to 60% maximum
 - Passing 3/4-inch square sieve: 0 to 10% maximum
- c. Riprap shall be reasonably well graded with gradation as follows:
 - Maximum stone size: 24 inches (nominal diameter)
 - Median stone size: 16 inches
 - Minimum stone size: 4 inches
- d. Riprap sizing is governed by side slopes on outlet channel, assumed to be approximately 3H:1V.

4.5.2 Methods of Analysis

This section presents the methods of analysis for designing new or evaluating existing culverts for compliance with the conveyance capacity requirements.

1) Design Flows

Design flows for sizing or assessing the capacity of culverts shall be determined using the hydrologic analysis methods described in [Volume II, Section 4.2](#).

2) Conveyance Capacity

The theoretical analysis of culvert capacity can be extremely complex because of the wide range of possible flow conditions that can occur due to various combinations of inlet and outlet submergence and flow regime within the culvert barrel. An exact analysis usually involves detailed backwater calculations, energy and momentum balance, and application of the results of hydraulic model studies.

However, simple procedures have been developed where the various flow conditions are classified and analyzed on the basis of a control section. A control section is a location where there is a unique relationship between the flow rate and the upstream water surface elevation. Many different flow conditions exist over time, but at any given time the flow is either governed by the culvert's inlet geometry (inlet control) or by a combination of inlet geometry, barrel characteristics, and tailwater elevation (outlet control). [Figure 4.11 illustrates—See Figure F.9 in Appendix F for](#) typical conditions of inlet and outlet control. The procedures presented in this section provide for the analysis of both inlet and outlet control conditions to determine which governs.

3) Inlet Control Analysis

Nomographs such as those provided in Figure F.10 and Figure F.11 in Appendix F may be used to determine the inlet control headwater depth at design flow for various types of culverts and inlet configurations. These nomographs were originally developed by the Bureau of Public Roads—now the Federal Highway Administration (FHWA)—based on their studies of culvert hydraulics. These and other nomographs can be found in the FHWA publication *Hydraulic Design of Highway Culverts, HDS No. #5 (Report No. FHWA-IP-85-15)*, September 1985; or the *WSDOT Hydraulic Manual*. See Appendix F for a detailed discussion on inlet control analysis.

4) Outlet Control Analysis

Nomographs such as those provided in Figure F.12 and Figure F.13 in Appendix F may be used to determine the outlet control headwater depth at design flow for various types of culverts and inlets. Outlet control nomographs other than those provided can be found in *FHWA HDS No.5* or the *WSDOT Hydraulic Manual*. See Appendix F for a detailed discussion on outlet control analysis.

4.6 Open Channels

Open channels may be classified as either natural or constructed. Natural channels are generally referred to as rivers, streams, creeks, or swales, while constructed channels are most often called ditches, or simply, channels. [See the Critical Areas Ordinance \(CAO\) codified as Title 19 KCC](#) ~~should be reviewed~~ for requirements related to streams.

4.6.1 Natural Channels

Natural channels are defined as those that have occurred naturally due to the flow of surface waters, or those that, although originally constructed by human activity, have taken on the appearance of a natural channel including a stable route and biological community. [Natural channels](#) ~~They~~ may vary hydraulically along each channel reach. [Such channels shall and should](#) be left in their natural condition, ~~wherever feasible or required~~, in order to maintain natural hydrologic functions and wildlife habitat benefits from established vegetation.

4.6.2 Constructed Channels

Constructed channels are those constructed or maintained by human activity and include bank stabilization of natural channels. Constructed channels shall be either vegetation-lined, rock-lined, or lined with appropriately bioengineered vegetation.

- [Vegetation-lined channels](#) are the most desirable of the constructed channels when properly designed and constructed. The vegetation stabilizes the slopes of the channel, controls erosion of the channel surface, and removes pollutants. The channel storage, low velocities, water quality benefits, and greenbelt multiple-use benefits create significant advantages over other constructed channels. The presence of vegetation in channels creates turbulence that results in loss of energy and increased flow retardation; therefore,

the design engineer shall consider sediment deposition and scour, as well as flow capacity, when designing the channel.

- Rock-lined channels may be needed where a vegetative lining will not provide adequate protection from erosive velocities. They may be constructed with riprap, gabions, or slope mattress linings. The rock lining increases the turbulence, resulting in a loss of energy and increased flow retardation. Rock lining also permits a higher design velocity and therefore a steeper design slope than in grass-lined channels. Rock linings are also used for erosion control at culvert and storm drain outlets, sharp channel bends, channel confluences, and locally steepened channel sections.
- Bioengineered vegetation lining is a desirable alternative to the conventional methods of rock armoring. Soil bioengineering is a highly specialized science that uses living plants and plant parts to stabilize eroded or damaged land. Properly bioengineered systems are capable of providing a measure of immediate soil protection and mechanical reinforcement. As the plants grow they produce a vegetative protective cover and a root reinforcing matrix in the soil mantle. This root reinforcement serves several purposes:
 - a. The developed anchor roots provide both shear and tensile strength to the soil, thereby providing protection from the frictional shear and tensile velocity components to the soil mantle during the time when flows are receding and pore pressure is high in the saturated bank.
 - b. The root mat provides a living filter in the soil mantle that allows for the natural release of water after the high flows have receded.
 - c. The combined root system exhibits active friction transfer along the length of the living roots. This consolidates soil particles in the bank and serves to protect the soil structure from collapsing and the stabilization measures from failing.
 - d. The vegetative cover of bioengineered systems provides immediate protection during high flows by laying flat against the bank and covering the soil like a blanket. It also reduces pore pressure in saturated banks through transpiration by acting as a natural "pump" to "pull" the water out of the banks after flows have receded.
- Bioretention facilities as described in Volume II, Chapter 5 can be designed for conveyance.

4.6.3 Design Criteria

1) General

- a. Open channels shall be designed to provide required conveyance capacity and bank stability while allowing for aesthetics, habitat preservation, and enhancement.
- b. An access easement for maintenance is required along all constructed channels located on private property. Required easement widths are listed in [Volume II](#), Section 4.3.3.

- c. Channel cross-section geometry shall be trapezoidal, triangular, parabolic, or segmental as shown in [Figure 4.11](#)~~Figure 4.11~~ through [Figure 4.13](#)~~Figure 4.13~~. Side slopes shall be no steeper than 3H:1V for vegetation-lined channels and 2H:1V for rock-lined channels.
- d. Vegetation-lined channels shall have bottom slope gradients of 6% or less and a maximum velocity at design flow of 5 fps (see Table 4.5).
- e. Rock-lined channels or bank stabilization of natural channels shall be used when design flow velocities exceed 5 fps. Rock stabilization shall be in accordance with Table 4.5 or stabilized with bioengineering methods as described ~~above~~ in [Volume II, Section 4.6.2 "Constructed Channels."](#)
- f. Open channels shall be designed to provide sufficient freeboard so as to not saturate any adjacent ~~public~~ road base when conveying the design flow. A minimum of 1 foot of freeboard is recommended, but in no case shall channel freeboard be less than 0.5 feet.

[Figure 4.11](#) Ditches – Common Sections

[Figure 4.12](#) Drainage Ditches – Common Sections

[Figure 4.13](#) Geometric Elements of Common Sections

2) *Riprap Design*

When riprap is set, stones are placed on the channel sides and bottom to protect the underlying material from being eroded. Proper riprap design requires the determination of the median size of stone, the thickness of the riprap layer, the gradation of stone sizes, and the selection of angular stones that will interlock when placed. See Appendix F for further guidance on riprap and riprap filter design.

[Table 4.5](#) Channel Protection

Discharge Velocity at Design Flow (fps)		Required Protection		
Greater than	Less than or equal to	Type	Thickness	Minimum Height Above Design Water Surface
0	5	Grass lining or bio-engineered lining	N/A	
5	8	Rock lining ^a or bio-engineered lining	1 foot	1 foot
8	12	Riprap ^{b,c}	2 feet	2 feet
12	20	Slope mattress gabion, etc.	Varies	2 feet

Notes:

-
- a. Rock lining shall be reasonably well graded as follows:
 - Maximum stone size: 12 inches
 - Median stone size: 8 inches
 - Minimum stone size: 2 inches
 - b. Riprap shall be reasonably well graded with gradation as follows:
 - Maximum stone size: 24 inches
 - Median stone size: 16 inches
 - Minimum stone size: 4 inches
 - c. Riprap sizing is governed by side slopes on outlet channel, assumed to be approximately 3H:1V.

4.6.4 Methods of Analysis

This section presents the methods of analysis for designing new or evaluating existing open channels for compliance with the conveyance capacity requirements.

1) Design Flows

Design flows for sizing and assessing the capacity of open channels shall be determined using the hydrologic analysis methods described in [Volume II, Section 4.2](#).

2) Conveyance Capacity

There are three acceptable methods of analysis for sizing and analyzing the capacity of open channels:

- a. Manning's equation for preliminary sizing;
- b. Direct Step backwater method; and
- c. Standard Step backwater method.

Appendix F provides further detailed guidance on each [of these methods discussed above](#).

4.7 Downstream Analysis

The following projects shall conduct an analysis of downstream water quantity and quality impacts resulting from the project and shall provide for mitigation of these impacts, in accordance with [KCC Section 12.10.070](#):

- All [Site Development Activity Permit \(SDAP\)](#) applications that meet any of the criteria listed in [KCC Section 12.10.060](#).
- All large projects ~~that trigger all nine minimum stormwater requirements~~ ([Chapter 12.08 KCC](#)).
- All project sites located within critical drainage areas.
- [All projects that implement TDAs](#).

The analysis shall extend a minimum of one-fourth (1/4) of a mile downstream from the project. The existing or potential impacts to be evaluated and mitigated shall include excessive sedimentation, erosion, discharges to ground water contributing or recharge zones, violations of water quality standards, and spills and discharges of priority pollutants.

The analysis shall begin with a Level 1 analysis ([Volume II, Section 4.7.1](#)). In areas where existing or predicted water quality and quantity problem were identified in the Level 1 analysis, proceed to a Level 2 analysis ([Volume II, Section 4.7.2](#)), which entails a rough quantitative analysis to define and evaluate proposed mitigation for the problem. In existing or predicted drainage problem locations, as defined by the director, proceed to Level 3 analysis. Level 3 analysis is similar to Level 2, but with more detailed quantitative analysis prepared by a licensed professional land surveyor or engineer ([Volume II, Section 4.7.3](#)). Each of the ~~three~~3 levels of analysis is described in detail ~~below~~ [in Volume II, Section 4.7.1, 4.7.2, and 4.7.3](#).

4.7.1 Level 1 Analysis

[Level 1 analysis](#) ~~This~~ is the minimum acceptable level of analysis. See Volume II, Chapter 1 (~~Preparation of Plans and Reports~~) for drainage report submittal requirements. The following steps shall be completed for this level of analysis:

1. Define and physically verify the study area. The upstream portion of the study area shall encompass the entire tributary drainage area (the area that drains to the proposed project site). The remaining portion of the study area shall extend downstream of the proposed project discharge location to a point on the drainage system where the proposed project site constitutes 15% or less of the total tributary area, but in no event less than one-fourth (1/4) of a mile.
2. Review all available resource information regarding existing and potential water quality, runoff volumes and rates, flooding and streambank erosion problems within the study area.
3. Physically inspect the existing on-site and off-site drainage system problems reported in the resources.
4. On a map (minimum USGS 1:24000 Quadrangle Topographic Map) delineate the study area, together with the drainage system onto and from the proposed site.
5. Describe in a narrative form, observations regarding the makeup and general condition of the drainage system.
6. Include such information as pipe sizes, channel characteristics, and [drainage stormwater](#) facilities.
7. Identify on the map and describe any evidence of the following types of existing or predicted problems:
 - Potential for contamination of surface waters.
 - Overtopping, scouring, bank sloughing or sedimentation.
 - Significant destruction of aquatic habitat or organisms (e.g., severe siltation or incision in a stream).
 - Potential for contamination of ground water.
8. Following the review of the Level 1 analysis, [the Kitsap](#) County will determine whether a Level 2 analysis is required, based on the evidence of existing or predicted problems.

4.7.2 Level 2 Analysis

At the location of each existing or predicted water quality and quantity problem identified in the Level 1 analysis, provide a rough quantitative analysis to define and evaluate proposed mitigation for the problem. ~~This analysis should include~~ the total composite drainage area tributary to that location for pre-development and post-development runoff conditions in the analysis. For this level of analysis, it ~~is will be~~ permissible to use non-survey field data (collected with hand tapes, hand level and rods, etc.) and approximate hydraulic computations.

The following steps shall be completed for this level of analysis:

1. Develop solutions to drainage problems identified by the analysis. For any existing or predicted off-site drainage problem, the engineer shall demonstrate that the proposed plan has been designed so that it neither aggravates the existing problem nor creates a new problem. As an alternative, the applicant may arrange with the owners of the affected off-site properties to install measures, which will correct the existing or predicted problem, subject to all applicable permit requirements.
2. Any proposed drainage easements shall be endorsed by the affected property owners and be recorded prior to approval of the proposed plan. In some cases, an existing drainage problem identified by the local government may be scheduled for solution. In these cases, the applicant should contact Kitsap County to check for potential cost sharing to solve the existing problem.
3. For any predicted off-site problem, the engineer shall demonstrate that the proposed plan has been designed to mitigate the predicted problem. As an alternative, the applicant may arrange with the owners of off-site properties to install measures, which will mitigate the predicted problem. Any proposed drainage easements shall be endorsed by the affected property owners and be recorded prior to approval of the proposed plan.

4.7.3 Level 3 Analysis

A Level 3 analysis shall be performed for those existing or predicted drainage problem locations where the director determines that the analysis results shall be as accurate as possible.

Examples of conditions that might require a Level 3 analysis include:

- If the site is flat and does not drain well;
- If the system is affected by downstream controls;
- If minor changes in the drainage system could flood roads, buildings or septic systems;
or
- If the proposed project will contribute more than 15% of the total peak flow to the drainage problem location.

The Level 3 analysis is similar to the Level 2 analysis but is a more precise quantitative analysis, utilizing field survey profile and cross-section topographic data prepared by a licensed professional land surveyor or engineer. The following steps shall be completed for this level of analysis:

1. Develop solutions to drainage problems identified by the analysis. For any existing or predicted off-site drainage problem, the engineer shall demonstrate that the proposed plan has been designed so that it neither aggravates the existing problem nor creates a new problem. As an alternative, the applicant may arrange with the owners of the affected off-site properties to install measures, which will correct the existing or predicted problem, subject to all applicable permit requirements.
2. Any proposed drainage easements shall be [endorsed-signed](#) by the affected property owners and be recorded prior to approval of the proposed plan. In some cases, an existing drainage problem identified by the local government may be scheduled for solution. In these cases, the applicant should contact [the Kitsap](#) County to check for potential cost sharing to solve the existing problem.
3. For any predicted off-site problem, the engineer shall demonstrate that the proposed plan has been designed to mitigate the predicted problem. As an alternative, the applicant may arrange with the owners of off-site properties to install measures, which will mitigate the predicted problem. Any proposed drainage easements shall be [endorsed-signed](#) by the affected property owners and be recorded prior to approval of the proposed plan.

4.8 Hydraulic Structures

4.8.1 Flow Splitters

Flow splitter structures can be used to route flows up to a target flow rate to a target facility (i.e., to a [Runoff Water Quality](#) Treatment BMP or a wetland), while bypassing flows that exceed the target flow rate to a downstream conveyance system or receiving water body. They typically include manholes or vaults with concrete baffles, inflow pipe(s), and outflow pipes. In place of baffles, the splitter mechanism may be a half tee section with a solid top and an orifice in the bottom of the tee section. A full tee option may also be used as described [below](#) in [Volume II](#), Section 4.8.1.1—[Design Criteria](#).

Two possible design options for flow splitters are shown in Figure 4.14 and Figure 4.15. Other similar designs that achieve the result of routing design flows to the target facility and diverting higher flows around the facility may also be acceptable.

[Figure 4.14](#) **Flow Splitter, Option A**

[Figure 4.15](#) **Flow Splitter, Option B**

4.8.1.1 Design Criteria

The following criteria shall be applied to the design of flow splitters. The term design flow rate used in the criteria [below in this section](#) refers to any design flow rate, such as a water quality design flow rate or maximum flow rate to wetlands, above which flows shall be bypassed:

1. The top of the baffle wall shall be located at the water surface for the design flow rate (e.g., water quality design flow rate, maximum flow rate to wetlands, etc.). Remaining flows enter the bypass line. Flows modeled using a continuous simulation model shall use a 15-minute time step.

2. The maximum head shall be minimized for flow in excess of the design flow rate. Specifically, flows to the target facility at the 100-year water surface shall not exceed the design flow rate by more than 10%.
3. Either design shown in Figure 4.14 or Figure 4.15, or a similar design may be used.
4. As an alternative to using a solid top plate in Figure 4.15, a full tee section may be used with the top of the tee at the 100-year water surface elevation. This alternative would route emergency overflows (if the overflow pipe were plugged) through the target facility rather than back up from the manhole.
5. Special applications, such as roads, may require the use of a modified flow splitter. The baffle wall may be fitted with a notch and adjustable weir plate to proportion runoff volumes other than high flows.
6. For ponding facilities, backwater effects shall be included in designing the height of the standpipe in the manhole or vault structure.
7. Ladder or step and handhold access shall be provided. If the baffle wall is higher than 36 inches, two ladders, one to either side of the wall, shall be used.

4.8.1.2 Materials

1. The baffle wall may be installed in a Type 2 manhole or vault.
2. The baffle wall shall be made of reinforced concrete or another suitable material resistant to corrosion, and have a minimum 4-inch thickness. The minimum clearance between the top of the baffle wall and the bottom of the manhole cover shall be 4 feet; ~~otherwise, dual access points should be provided.~~ unless dual access points are provided.
3. All metal parts shall be corrosion resistant. Examples of preferred materials include aluminum, stainless steel, and plastic. Zinc and galvanized materials are discouraged because of aquatic toxicity. Do not use pPainted metal parts ~~should not be used~~ because of poor longevity.

4.8.2 Flow Spreaders

Flow spreaders function to uniformly spread flows across the inflow portion of runoff treatment BMPswater quality facilities (e.g., sand filter, bioretention swalebiofiltration swale, or filter strip).

There are five flow spreader options presented herein this section:

- Option A – Anchored plate
- Option B – Concrete sump box
- Option C – Notched curb spreader
- Option D – Through-curb ports
- Option E – Interrupted curb

Options A through C can be used for spreading flows that are concentrated. Any one of these options can be used when spreading is required by the facility design criteria. Options A through

C can also be used for unconcentrated flows, and in some cases shall be used, such as to correct for moderate grade changes along a filter strip.

Options D and E are only for flows that are already unconcentrated and enter a filter strip or bioretention system. Other flow spreader options may be possible [upon approval from Kitsap County](#).

4.8.2.1 Design Criteria

Where flow enters the flow spreader through a pipe, it is recommended that the pipe be submerged to the extent practical to dissipate energy as much as possible.

[Flow spreaders are difficult to maintain to ensure that flow is evenly distributed. Flow spreaders shall not be used on slopes greater than 5% to prevent recombining of downstream flow that can create rills and gullies. Flow spreaders shall not be used in areas accessible by the public since walking on them can alter their flow characteristics.](#)

For higher inflows (greater than 5 cfs for the 100-year storm recurrence interval), [position](#) a Type 1 catch basin ~~should be positioned~~ in the spreader and [design](#) the inflow pipe ~~should to~~ enter the catch basin with flows exiting through the top grate. The top of the grate should be lower than the level spreader plate, or if a notched spreader is used, lower than the bottom of the v-notches.

Option A -- Anchored Plate ~~(See Figure 4.17)~~

1. An anchored plate flow spreader ([see Figure 4.16](#)) shall be preceded by a sump having a minimum depth of 8 inches and minimum width of 24 inches. If not otherwise stabilized, the sump area shall be lined to reduce erosion and to provide energy dissipation.
2. The top surface of the flow spreader plate shall be level, projecting a minimum of 2 inches above the ground surface of the [runoff treatment BMP](#)~~water quality facility~~, or V-notched with notches 6 to 10 inches on center and 1 to 6 inches deep (use shallower notches with closer spacing). Alternative designs may also be used.
3. A flow spreader plate shall extend horizontally beyond the bottom width of the facility to prevent water from eroding the side slope. The horizontal extent ~~shall~~[should](#) be such that the bank is protected for all flows up to the 100-year flow or the maximum flow that will enter the [BMP](#)~~WQ facility~~.
4. Flow spreader plates shall be securely fixed in place.
5. Flow spreader plates may be made of either wood, metal, fiberglass reinforced plastic, or other durable material. If wood, pressure treated 4 by 10-inch lumber or landscape timbers are acceptable.
6. Anchor posts shall be 4-inch square concrete, tubular stainless steel, or other material resistant to decay.

[Figure 4.16](#) Flow Spreader Option A: Anchored Plate

Option B -- Concrete Sump Box ~~(See Figure 4.18)~~

1. The wall of the downstream side of a rectangular concrete sump box [\(see Figure 4.17\)](#) shall extend a minimum of 2 inches above the treatment bed. This serves as a weir to spread the flows uniformly across the bed.
2. The downstream wall of a sump box shall have “wing walls” at both ends. Side walls and returns shall be slightly higher than the weir so that erosion of the side slope is minimized.
3. Concrete for a sump box can be either cast-in-place or precast, but the bottom of the sump shall be reinforced with wire mesh for cast-in-place sumps.
4. Sump boxes shall be placed over bases that consists of 4 inches of crushed rock, 5/8-inch minus to help assure the sump remains level.

Figure 4.17. Flow Spreader Option B: Concrete Sump Box

Option C -- Notched Curb Spreader ~~(See Figure 4.19)~~

Notched curb spreader sections [\(see Figure 4.18\)](#) shall be made of extruded concrete laid side-by-side and level. Typically five “teeth” per four-foot section provide good spacing. The space between adjacent “teeth” forms a v-notch.

Figure 4.18. Flow Spreader Option C: Notched Curb Spreader

Option D -- Through-Curb Ports ~~(See Figure 4.20)~~

Unconcentrated flows from paved areas entering filter strips or ~~bioretention~~[continuous inflow biofiltration](#) swales can use ~~through-curb~~ ports [\(see Figure 4.19\)](#) or interrupted curbs (Option E) to allow flows to enter the ~~BMP strip or swale~~. ~~Through-c~~ Curb ports use fabricated openings that allow concrete curbing to be poured or extruded while still providing an opening through the curb to admit water to the ~~BMPWQ facility~~. Openings in the curb shall be at regular intervals but at least every 6 feet (minimum). The width of each curb port opening shall be a minimum of 11 inches. Approximately 15% or more of the curb section length should be in open ports, and no port should discharge more than about 10% of the flow.

Figure 4.19. Flow Spreader Option D: Through-Curb Port

Option E -- Interrupted Curb ~~(No Figure)~~

Interrupted curbs are sections of curb placed to have gaps spaced at regular intervals along the total width (or length, depending on [the BMP facility](#)) of the treatment area. At a minimum, gaps shall be every 6 feet to allow distribution of flows into the ~~BMP treatment facility~~ before they become too concentrated. The opening shall be a minimum of 11 inches. As a general rule, no opening should discharge more than 10% of the overall flow entering the ~~BMP facility~~.

CHAPTER 5 STORMWATER MANAGEMENT BMPS

5.1 Purpose of This Chapter

This chapter presents approved methods, requirements, criteria, details, and general guidance for selection, analysis and design of on-site stormwater management, [Water Quality runoff](#) treatment, and flow control [best management practices](#) (BMPs) consistent with [Title 12 KCC](#). These BMPs are designed to reduce the flow rates or volumes of stormwater runoff and/or reduce the level of pollutants leaving the project site. In accordance with provisions of the [Title 12 KCC](#), additional BMPs beyond those specified in this volume may be required.

5.2 Organization of This Chapter

The remainder of this chapter is organized as follows:

- [Volume II](#), Section 5.3 describes the steps required to select appropriate BMPs after the minimum requirements (MRs) for On-site Stormwater Management (MR #5), Runoff Treatment (MR #6), and/or Flow Control (MR #7) have been determined using Volume I, Chapter 3. This section is organized into the following subsections:
 - [Volume II](#), Section 5.3.1 provides information on how to determine if dispersion is a feasible stormwater management practice for the project.
 - [Volume II](#), Section 5.3.2 provides information on how to determine if infiltration is a feasible stormwater management practice for the project.
 - [Volume II](#), Section 5.3.3 discusses the process for selecting On-site Stormwater Management BMPs to satisfy MR #5. See also the [Low Impact Development \(LID\) BMP Infeasibility Criteria](#) in Appendix H, which ~~must~~ shall be evaluated and documented as part of the Site Assessment and Planning Packet submittal required per Volume II, Chapter 1.
 - [Volume II](#), Section 5.3.4 discusses the process for selecting [Water QualityRunoff](#) Treatment BMPs to satisfy MR #6.
 - [Volume II](#), Section 5.3.5 discusses the process for selecting Flow Control BMPs to satisfy MR #7.
- [Volume II](#), Section 5.4 provides descriptions and criteria for designing BMPs to meet the on-site stormwater management, [Water Qualityrunoff](#) treatment, and flow control requirements of the project. This section is intended to be used in conjunction with several other relevant design guidance manuals, which are referenced where appropriate, ~~including~~:
 - *Stormwater Management Manual for Western Washington* (Ecology Manual) by the Washington State Department of Ecology Water Quality Program, [July 2019](#).
 - *Western Washington Low Impact Development (LID) Operations and Maintenance (O&M)*, by the Washington State Department of Ecology Water Quality Program, May 2013.

- o [Low Impact Development Technical Guidance Manual for Puget Sound](#) (LID Technical Guidance Manual) by [Hinman and Wulkan](#), December 2012.
- o [Rain Garden Handbook for Western Washington Homeowners](#) (Rain Garden Handbook) by [Hinman et. al, June 2013](#).
- a. ~~[Guidance for Underground Injection Control Wells that Manage Stormwater by the Washington State Department of Ecology, 2006.](#)~~

The guidance provided in this manual supersedes the above referenced manuals in the event of conflicting guidelines or standards. The referenced manuals are prioritized in the order they are listed above, with the highest priority given to the Ecology Manual and the lowest priority given to the [Rain Garden Handbook for Western Washington Homeowners](#). This manual will direct the user to the appropriate sections in these or other relevant manuals where applicable.

Appendix G provides requirements and standards to be used for subsurface characterization and infiltration testing.

- Appendix H provides LID BMP infeasibility criteria.

5.3 BMP Selection

This section describes the steps for selecting appropriate stormwater BMPs and is organized into the following five sections:

- [Volume II](#), Section 5.3.1 – Determine Dispersion Feasibility
- [Volume II](#), Section 5.3.2 – Determine Infiltration Feasibility
- [Volume II](#), Section 5.3.3 – Select BMPs for On-site Stormwater Management
- [Volume II](#), Section 5.3.4 – Select BMPs for Flow Control
- [Volume II](#), Section 5.3.5 – Select BMPs for [RunoffWater Quality](#) Treatment

Since dispersion and infiltration BMPs can serve multiple functions (On-site Stormwater Management, Flow Control, or [Water QualityRunoff](#) Treatment), the process for evaluating feasibility for these types of BMPs shall be conducted first. Following the dispersion and infiltration feasibility determination are specific steps related to MR #5-7 (On-site Stormwater Management, [RunoffWater Quality](#) Treatment, and Flow Control, respectively).

Note that one, two, or all three of these minimum requirements may apply. Also note that MR #1-4 and MR #8 and 9 may also apply. See Volume I, [Chapters 3 and 4](#) to determine which minimum requirements apply to the project and the standards for complying with all minimum requirements.

[For additional information on how to select BMPs for source control, see Volume II, Section 3.5.](#)

5.3.1 Determine Dispersion Feasibility

Dispersion BMPs include full dispersion, sheet flow dispersion, and concentrated flow dispersion ([Volume II, Section 5.4.4](#)). The following two steps for determining dispersion feasibility are outlined in the subsequent sections:

- *Step 1* – Evaluate horizontal setbacks and site constraints.
- *Step 2* – Evaluate use of dispersion to meet minimum requirements.

Step 1: Evaluate horizontal setbacks and site constraints

Assess horizontal setbacks, flow path requirements, and site constraints to determine dispersion feasibility for the site, as follows:

Horizontal Setbacks

Horizontal setbacks vary depending on the type of dispersion BMP selected; [refer to see Volume II, Section 5.4.4](#) for horizontal setback requirements for each dispersion BMP type.

Flow Path Requirements

Dispersion BMPs have minimum requirements for a [dispersion area and](#) vegetated flow path that can be difficult to achieve on sites with limited space, such as in urban environments.

Assess the [minimum dispersion following flow path requirements per Table 5.1. This table is intended to help the designer determine whether the minimum flow path requirements can be achieved given site constraints. If dispersion BMPs are not infeasible based on these minimum requirements, see Volume II Section 5.4.4 for the comprehensive requirements pertaining to dispersion BMP design.](#)

- ~~Full Dispersion – The flowpath shall be directed over a minimum of 100 feet of vegetation.~~
- ~~Sheet Flow Dispersion – The flowpath shall be directed over a minimum of 10 feet of vegetation.~~
- ~~Concentrated Flow Dispersion, Trench Downspout Dispersion and Splashblock Downspout Dispersion – The flowpath shall be directed over a minimum of 25 feet of vegetation.~~

Table 5.1. Summary of Minimum Dispersion Flow Path Area and Length Requirements

<u>Dispersion Type</u>	<u>Flow Path Description</u>	<u>Flow Path Length</u>
<u>BMP T5.30: Full Dispersion – Residential Projects</u>		
<u>From Impervious Surfaces</u>	<u>From impervious surface through the area preserved as forest or native vegetation</u>	<u>≥ 100 feet</u>
	<u>Sheet flow from lawn to landscaping areas associated with</u>	<u>≥ 25 feet</u>

	the impervious area being mitigated	
From Cleared Areas	Through the cleared area (and leading to the dispersion area)	≤ 25 feet
	From the cleared area through the dispersion area	For cleared area width ≤ 25 feet: ≥ 25 feet For cleared area width between <u>25 and 250 feet</u> : 25 feet plus additional 1 foot for every 3 feet of width cleared area (beyond the initial 25 feet) up to a maximum width of 250 feet.
BMP T5.30: Full Dispersion – Public Road Projects ^a		
By Sheet Flow from Uncollected, Unconcentrated Runoff into the Dispersion Area	From impervious area leading to the dispersion area	≤ 75 feet
	Pervious area leading to the dispersion area	≤ 150 feet
	Through the dispersion area	Varies by soil type (see Minimum Design Requirements for Public Road Projects in BMP T5.30 in Volume V, Chapter 3 of the Ecology Manual)
Channelized (Collected and Re-dispersed) Stormwater into the Dispersion Area	Shall be re-dispersed to produce longest possible flow path	Varies by soil type (see Minimum Design Requirements for Public Road Projects in BMP T5.30 in Volume V, Chapter 3 of the Ecology Manual)
Engineered Dispersion	--	Varies by soil type (see Minimum Design Requirements for Public Road Projects in BMP T5.30 in Volume V, Chapter 3 of the Ecology Manual)
BMP T5.10B: Downspout Dispersion ^b		
Dispersion Trench	Vegetated flow path	≥ 25 feet
	Vegetated flow path between outlet and any slope steeper than 15%	≥ 50 feet
Splashblock	Vegetated flow path	≥ 50 feet
BMP T5.11: Concentrated Flow Dispersion		

All	<u>Vegetated flow path</u>	<u>>25 feet</u>
<u>BMP T5.12: Sheet Flow Dispersion</u>		
All	=	<u>≥10 feet</u>

- a. Review minimum design requirements for Public Road Projects per BMP T5.30 in Volume V, Chapter 3 of the Ecology Manual prior to evaluating these criteria.
- b. If vegetated flow path is less than 25 feet, Perforated Stub-out Connections (see Volume II, Section 5.4.7) may be used in lieu of downspout dispersion.

Site Constraints

- Steep Slope or Landslide-prone and Erosion Hazard Areas – The dispersion flow path is not typically permitted within landslide hazard areas (Title 19 KCC), on or above slopes greater than 20%, or above erosion hazard areas a steep slope (>15%), or within a setback of 10 times the height of the steep slope to a maximum of 500 feet above a steep slope area.
 - Full Dispersion – Dispersion area is not allowed in critical area buffers or on slopes steeper than 20%. Dispersion areas proposed on slopes steeper than 15% and within 50 feet of a geologically hazardous area (RCW 37.07A.030(5)) shall be approved by a geotechnical engineer or engineering geologist.
 - Sheet Flow Dispersion and Concentrated Flow Dispersion – Runoff discharge toward landslide hazard areas shall be evaluated by a geotechnical engineer or qualified geologist. Do not allow sheet flow on or above slopes greater than 20%, or above erosion hazard areas, without evaluation by a geotechnical engineer or qualified geologist and approval by Kitsap County.
 - Downspout Dispersion Systems – Have a geotechnical engineer or a licensed geologist, hydrogeologist, or engineering geologist evaluate runoff discharged towards landslide hazard areas. Do not place the discharge location from splash blocks or dispersion trenches on or above slopes greater than 20% or above erosion hazard areas without evaluation by a licensed engineer in the state of Washington with geotechnical expertise or a licensed geologist, hydrogeologist, or engineering geologist, and approval by Kitsap County.
- Septic Systems and Drainfields – The dispersion flow path is not permitted within 10 feet of a proposed or existing septic system or drainfield.
 - Full Dispersion, Downspout dispersion systems – For sites with on-site sewage disposal systems, the discharge of runoff from the dispersion area shall be located downslope of the primary and reserve drainfield areas. This requirement may be waived by the permitting jurisdiction if site topography clearly prevents discharged flow from intersecting the drainfield.
- Sheet Flow Dispersion, Concentrated Flow Dispersion. The discharge area shall be 10 feet downgradient of the drainfield primary and reserve areas (Table 5.2 and WAC 246-272A-0210). Kitsap Public Health District may waive this requirement if site topography clearly prohibits flows from intersecting the drainfield.

- [Drinking Water Supply Wells or Springs – See Table 5.3 for infiltration setback requirements to private and public wells. See Kitsap County Board of Health Ordinance 2008A-01, as now or hereafter amended, for additional setback information.](#)
- Contaminated Sites and Landfills – The dispersion flow path is not permitted within 100 feet of a contaminated site or landfill (active or closed).

Table 5.2. Minimum Horizontal Setback Requirements between Stormwater ~~BMPs~~Control Devices and On-site Sewage System (OSS) Components

Location (with Respect to OSS Components) and Type of Stormwater Control Device ^{a,b} Stormwater BMP ^{a,b}	From Edge of Soil Dispersal Component OSS Primary or and Reserve Soil Dispersal Area (Feet) ^c	From Edge of OSS Sewage Tank or Treatment Tank and Distribution Box (Feet) ^c	From Building Sewer and Nonperforated Distribution Pipe (Feet) ^c
UPGRADIENT			
Individual Lot Infiltration System	30	30	N/A
Individual Lot Dispersion System	30	30	N/A
Individual Lot Rain Garden	30	10	N/A
Individual Lot Downspout Splash Blocks	10	10	N/A
DOWN- OR SIDE-GRADIENT			
Individual Lot Infiltration System	10	10	N/A
Individual Lot Dispersion System	10	10	N/A
Individual Lot Rain Garden	30	10	N/A
Individual Lot Downspout Splash Blocks	10	10	N/A
UP-, DOWN-, OR SIDE-GRADIENT			
Regional Infiltration Facility	100	100	N/A
Unlined Detention Ponds/ Infiltration Basins	30 100	30 50	10

Notes:

[N/A](#) Not Applicable.

a. ~~BMP horizontal setback distances shall be As-~~measured from closest edge of ~~stormwater control device~~the ~~BMP~~ to the feature of interest.

b. ~~BMP discharge point(s)-~~location(s) and flow path(s) ~~must~~shall be directed away from or around OSS.

c. ~~If the Kitsap County Board of Health setback conflicts with this manual, the Kitsap County Health District setback will take precedence.~~

Table 5.3 – Minimum Horizontal Setback Requirements Between Stormwater ~~BMPs~~Control Devices and Private/Public Wells

Stormwater BMP Control Device ^a	Private Well (Feet) ^b	Public Well (Feet) ^b
Individual Lot Infiltration System	30	100

Individual Lot Dispersion System	50	100
Individual Lot Rain Garden	50	100
Individual Lot Downspout Splash Blocks	30	50
Unlined Detention Ponds/ Infiltration Basins	50	100
Regional Infiltration Facility	100	100

Note:

a. Discharge ~~points(e)-location(s)~~ and flow path(s) ~~shall~~**must** be directed away from wells.

a-b. [If the Kitsap County Board of Health setback conflicts with this manual, the Kitsap County Health District setback will take precedence.](#)

Step 2: Evaluate use of dispersion to meet minimum requirements

If dispersion is considered feasible for the site, evaluate the feasibility of individual dispersion BMPs ([Volume II, Section 5.4.4](#)) when selecting BMPs for on-site stormwater management ([Section 5.3.3](#)), ~~runoff treatment~~[water quality](#) ([Volume II, Section 5.3.4](#)), and flow control ([Volume II, Section 5.3.5](#)).

5.3.2 Determine Infiltration Feasibility

This section provides step-by-step procedures for evaluating the feasibility of infiltration for a site and determining design infiltration rates for ~~facility~~[BMP](#) design. Each of the following steps is outlined in more detail in the subsequent sections:

- *Step 1* – Evaluate horizontal setbacks and site constraints.
- *Step 2* – Conduct subsurface investigation and evaluate vertical separation requirements. [Review Appendix G, section G2.2.3 for additional guidance, prior to conducting the investigation.](#)
- *Step 3* – Conduct infiltration testing.
- *Step 4* – Determine design infiltration rate.
- *Step 5* – Conduct groundwater monitoring, receptor characterization, ~~and~~ mounding and seepage analysis, and [infiltration testing for permeable pavement surfaces](#)~~acceptance testing~~, if applicable.
- *Step 6* – Evaluate use of infiltration to meet minimum requirements.

Seasonal timing for geotechnical/soils investigations, infiltration testing and groundwater monitoring requirements for infiltration ~~facilities~~[BMPs](#) can impact project schedules. Subsurface investigations shall be scheduled during the wet season, between December and March, whenever possible.

The Developer may choose to perform Steps 2 through 5 concurrently, or in series. Larger projects may benefit from consulting with a licensed professional early in project development. Refer to [\(See separate file for Public Review Draft figures\)](#) for a flowchart illustrating these steps for completing an infiltration feasibility assessment.

Step 1: Evaluate Horizontal Setbacks and Site Constraints

Evaluate the following criteria related to limitations, horizontal setbacks, and contaminated soil or groundwater. For any portion of the site that falls within an area that limits or restricts infiltration BMPs, as documented and approved through the Site Assessment and Planning submittal review (Volume I, Section 2.5 ~~of this manual~~), further infiltration investigation to meet the On-site Stormwater Management, Flow Control, or ~~Runoff~~Water Quality Treatment requirements is not required. An infiltration feasibility flow chart is presented in ~~Figure 5-1~~Figure 5.4.

(See separate file for Public Review Draft figures)

Figure 5-1. Infiltration Feasibility Flow Chart

Assess horizontal setbacks and site constraints to determine infiltration feasibility for the site, as follows:

Horizontal Setbacks

For ~~infiltrating~~infiltration bioretention and rain gardens, horizontal setbacks are measured from the vertical extent of the cell or basin (e.g., top of the bioretention soil). For infiltration chambers, horizontal setbacks are measured from the outside bottom of the structure. For all other infiltration BMPs, horizontal setbacks are measured from the edge of the aggregate within the BMP.

Infiltration is not permitted in the following areas:

- Within 10 feet of property lines (may be reduced from ~~right-of-way~~right of way with County approval).
- Within 10 feet of another infiltration ~~facility~~BMP.
- Within the following setbacks from structures (on- ~~and off-site~~ ~~and off-site structures~~):
 - When runoff from less than 5,000 square feet of impervious surface area is infiltrated on the site, the infiltration BMP shall not be within 5 feet from a building without a basement, and/or 10 feet from a building with a basement.
 - When runoff from 5,000 square feet or more of impervious surface area is infiltrated on the site, a building shall not intersect with a slope 1 Horizontal to 1 Vertical (1H:1V) from the bottom edge of an infiltration BMP. The resulting setback shall be no less than 5 feet from a building without a basement and/or 10 feet from a building with a basement. For setbacks from buildings or structures on adjacent lots, potential buildings or structures shall be considered for future build-out conditions.
- Within Kitsap County Board of Health specified setbacks for drinking water wells, septic tanks, and drainfields.
- Within 100 feet from open water features and designated landslide hazards.
- Within 200 feet from springs and flowing artesian wells used for drinking water supply. Infiltration BMPs upgradient of drinking water supplies shall comply with Health Department requirements.

- [Within 50 feet from the top of any slope over 15%.](#)

Site Constraints

- Steep Slope or Landslide-Hazard Areas – Infiltration is limited within landslide-prone areas or within a setback of 10 times the height of the steep slope to a maximum of 500 feet above a steep slope area. Infiltration within this area may be feasible provided a detailed slope stability analysis is completed by a licensed engineer or engineering geologist. The analysis shall determine the effects that infiltration would have on the landslide-prone or steep slope area and adjacent properties.
- Septic Systems and Drainfields – See [Table 5.2](#) for infiltration setback requirements to on-site sewage systems. Refer to [the Kitsap County Board of Health Ordinance 2008A-01, as now or hereafter amended, Kitsap County Public Health District code and requirements](#) for additional setback information.
- Drinking Water Supply Wells or Springs – See [Table 5.3](#) for infiltration setback requirements to private and public wells. [Refer to the Kitsap County Board of Health Ordinance 2008A-01, as now or hereafter amended, for additional setback information](#)~~Refer to Kitsap County Public Health District code and requirements for additional setback information.~~
- Contaminated Sites and Landfills –
 - Within 100 feet of a contaminated site or landfill (active or closed). For projects where runoff from 5,000 square feet or more of impervious surface area will be infiltrated on the site, infiltration within 500 feet up-gradient or 100 feet down-gradient of a contaminated site or landfill (active or closed) requires analysis and approval by a licensed hydrogeologist.
 - ~~Infiltration is infeasible w~~~~here~~ ~~soil and/or groundwater contamination problems have been identified~~ ~~by~~, including, but not limited to, the following:
 - EPA Superfund Program site list (www.epa.gov/superfund/search-superfund-sites-where-you-live)
 - ~~EPA Resource Conservation and Recovery Act (RCRA) Program site list~~ (www.epa.gov/epawaste/hazard/correctiveaction/facility/index.htm)
 - EPA mapping tool that plots the locations of Superfund and [Resource Conservation and Recovery Act \(RCRA\)](#)-regulated sites (www2.epa.gov/cleanups/cleanups-my-community)
 - Ecology regulated contaminated sites (www.ecy.wa.gov/fs)
 - Ecology Toxics Cleanup Program website (www.ecy.wa.gov/cleanup.html)
- Underground or Above Ground Storage Tanks –

- [Infiltration is infeasible w](#)Within 10 feet of an underground or above ground storage tank or connecting underground pipes when the capacity of the tank and pipe system is 1,100 gallons or less. (Applicable to tanks used to store petroleum products, chemicals, or liquid hazardous wastes.)
- [Infiltration is infeasible w](#)Within 100 feet of an underground or above ground storage tank or connecting underground pipes when the capacity of the tank and pipe system is greater than 1,100 gallons. (Applicable to tanks used to store petroleum products, chemicals, or liquid hazardous wastes.)

Step 2: Conduct Subsurface Investigation and Evaluate Vertical Separation Requirements

The applicant may choose to perform Steps 2 and 3 in either order or concurrently (i.e., infiltration testing can be done before or during a subsurface investigation and evaluation of vertical separation requirements).

Subsurface Investigations

Subsurface investigations are required to identify subsurface and groundwater conditions that may affect performance of the infiltration [facilityBMP](#). Investigations shall be performed at the location of the proposed [facility-BMP](#) or as close as possible, but no more than 50 feet away. The number and type of subsurface investigations required are provided in

4. Seasonal timing for infiltration testing and groundwater monitoring requirements for infiltration [BMPsfacilities](#) can impact project schedules. Subsurface investigations shall be scheduled during the wet season, between November and March, whenever possible. Larger projects may benefit from consulting with a licensed professional early in project development.

This manual includes four types of subsurface investigations:

- Simple subsurface investigation (limited applications in rural areas only; [refer to see](#) Table 5.4);
- Standard subsurface investigation;
- Comprehensive subsurface investigation; and
- Deep infiltration subsurface investigation.

Subsurface investigation is required for the entire site or portion(s) of the site that have not been excluded based on information reviewed in Step 1.

The type of subsurface investigation required for a project is provided in

and varies by the impervious surface area infiltrated on site. Subsurface investigation requirements and standards are provided in Appendix G. As indicated in [Appendix G that appendix](#), a licensed professional shall conduct the subsurface investigation for standard, comprehensive, and deep infiltration investigation. A licensed professional is not required for simple subsurface investigations.

Projects shall document the results of the required subsurface investigation and evaluation of vertical separation requirements. The information to be contained in this report is provided in Volume II, Chapter 1.

Where feasible and recommended by the licensed professional, deep infiltration BMPs can be used to direct stormwater past surface soil layers that have lower infiltration rates and into well-draining soils. The nature and depth of the soil layers with lower infiltration rates can vary significantly, so the technique required to reach the well-draining soils will also vary. Consult with the licensed professional to determine if deep infiltration is feasible.

Vertical Separation Requirements

Vertical separation requirements shall be evaluated when performing a subsurface investigation. Infiltration BMPs require a minimum vertical separation from the lowest elevation of the [BMP facility](#) to the underlying groundwater table or hydraulically restrictive material. Groundwater elevation data shall be used to evaluate the bottom of the [BMP facility](#) against the vertical separation requirements to determine infiltration feasibility.

The vertical separation requirements for shallow infiltration BMPs depend upon the type of subsurface investigation required and the seasonal timing of the geotechnical exploration conducted to evaluate clearances. [SeeRefer to](#) Appendix G for additional information.

A determination of infiltration infeasibility may be approved (without proceeding to Step 3 – Conduct Infiltration Testing) if the Geotechnical Analysis/Soils Report ([see](#) Volume II, Chapter 1) documents that groundwater seepage or a hydraulically-restrictive material is encountered within the vertical separation requirements specified [in](#) Appendix G.

Table 5.4. Summary of Minimum Investigation and Testing Requirements for Shallow Infiltration BMPs, Steps 2, 3, and 5^a.

Impervious Area Infiltrated on the Project Site	Step 2		Step 3		Step 5			
	Subsurface Investigation		Infiltration Testing		Groundwater Monitoring		Characterization of Infiltration Receptor	Groundwater Mounding & Seepage Analysis
	Minimum Number	Type	Minimum Number	Type	Minimum Number of Wells	Duration & Frequency		
< 2,000 ft ²	1 per facility BMP AND at least 1 per 150 linear feet of a facility BMP ^{e,de,f}	Simple subsurface investigation	For Grain Size Analysis	Simple Infiltration Test ^b or Grain Size Analysis ^{c, d}	0	NA	No	No
≥ 2,000 to < 5,000 ft ²		Standard subsurface investigation	At least one per 5,000 square feet of infiltration basin (BMP T7.10) AND at least one per 200 linear feet of trench length (BMP T7.20) AND in no case fewer than 2 tests per BMP	Simple Infiltration Test ^b Grain Size Analysis ^{e, g} -or Small Pilot Infiltration Test (PIT); if ≥ 2,000 ft ² of the site infiltration will occur within a single facility-BMP ^{eg} , the Small PIT ^{f, d} method is required	0	NA	No	No
≥ 5,000 to < 10,000 ft ²		Comprehensive subsurface investigation ^{g, h}	For all other test types:	Small PIT ^{fd} or Grain Size Analysis ^{c, d}	1	Monthly for at least 1 wet season; monthly for at least 1 year if within 200 feet of a designated receiving water ^{h, i}	Yes, for infiltration basins	No
≥ 10,000 ft ² to < 1 acre				Small PIT ^{fd} or Grain Size Analysis ^{c, d}	3			
≥ 1 acre				Small or Large PIT ^{fd} or Grain Size Analysis ^{c, d}				

Notes:

- a. Deviations from the minimum requirements in this table, when recommended and documented by the licensed professional, may be approved by the director. If the licensed professional determines continuity or subsurface materials based on site investigations or if [acceptance-infiltration](#) testing will be done during construction, then fewer tests may be approved. Designs for infiltration [facilities-BMPs](#) shall provide allowances for review and update during construction if site conditions differ than assumed during design or if [acceptance-infiltration](#) test during construction (as specified in the designs) determines that the infiltration rate is lower than assumed for the design.
- b. The Simple Infiltration Test is not allowed for projects with no off-site point of discharge. The Simple Infiltration Test is only allowed for project sites located in rural areas (outside the UGA and UA), with the drainage area limitations listed in this table. The Small PIT or Large PIT shall be used where the Simple Infiltration Test is not applicable or not allowed.
- ~~c. Grain Size Analysis is allowed for rural (outside the UA and UGA) residential project sites and can only be used if the site has soils unconsolidated by glacial advance. Refer to Volume V, Section V-5.5 of the Ecology Manual for additional guidance.~~
- ~~The investigation and infiltration testing report shall be prepared by a licensed professional. See Volume II, Chapter 1 for report requirements.~~
- ~~d.~~
- e. For bioretention or rain gardens, a [facility-BMP](#) refers to either a single cell, or a series of cells sized to meet applicable standards.
- f. The investigation shall be conducted at the location of the proposed infiltration [facility-BMP](#) whenever possible. When not possible to conduct the investigation at the proposed [BMPfacility](#) location, it ~~must-shall~~ be conducted within 50 feet of the proposed [facility-BMP](#) location.
- e.g. A single [BMPfacility](#) is defined as a [BMPfacility](#) that has at least a 10-foot separation distance from another infiltration [facilityBMP](#), measured from the closest vertical extent of maximum ponding before overflow, or for bioretention and rain gardens, the maximum vertical extent of the top of the bioretention soil or compost amended soil.
- ~~d.g. The investigation and infiltration testing report shall be prepared by a licensed professional. See Volume II, Chapter 1 for report requirements.~~
- e.h. For projects where runoff from 5,000 square feet or more of impervious surface area will be infiltrated on the site, infiltration within 500 feet up-gradient or 100 feet down-gradient of a contaminated site or landfill (active or closed) requires analysis and approval by a licensed hydrogeologist.
- f.i. If the project site is within 200 feet of tidal waters, groundwater data capturing low/high tide fluctuation for one wet season shall be collected to determine if groundwater at the project is influenced by tidal fluctuations. Groundwater monitoring is not required if available groundwater elevation data within 50 feet of the proposed [facility-BMP](#) shows the highest measured groundwater level to be at least 10 feet below the bottom of the proposed infiltration [BMPfacility](#) or if the initial groundwater measurement is more than 15 feet below the bottom of the proposed infiltration [facilityBMP](#).
- g.j. Groundwater mounding and seepage analysis is required where the depth to the seasonal high groundwater elevation or hydraulically ~~-~~restrictive material is less than 15 feet below the bottom of the proposed infiltration [BMPfacility](#).

Step 3: Conduct Infiltration Testing

This manual includes [five](#) allowed methods of field infiltration testing to determine the measured infiltration rate:

- Simple Infiltration Test (limited application in rural areas only; see [Table 5.4](#))
- Small Pilot Infiltration Test (PIT)
- Large PIT
- Deep Infiltration Test
- [Grain Size Analysis \(limited application in rural areas for residential only; see Table 5.4\)](#)

The type of infiltration test required for a project is provided in

and varies by the impervious surface area routed to infiltration BMPs on a site. The required procedures that must shall be used for small and large PITs the Simple Infiltration Test and Grain Size Analysis are provided in the Ecology Manual, Volume III, Section 3.3.6 Appendix G. The required procedures for the Simple Infiltration Test and the minimum requirements for the Deep Infiltration Test are provided in Appendix G of this manual.

Test reports for the Small and Large PITs and Deep Infiltration Tests and Grain Size Analysis shall be prepared by a licensed professional. The Simple Infiltration Test does not require a licensed professional.

The minimum allowed infiltration rates are provided in Table 5.5. The values vary by infiltration BMP type and by the approach that will be used to meet MR #5: On-site Stormwater Management. SeeRefer to Volume I, Section 4.2.5 for additional discussion of these approaches, which include the List approach and the LID Performance Standard approach.

Table 5.5 Minimum Measured Infiltration Rates

Infiltration BMP	Minimum Measured Infiltration Rate for List Approach (in/hr)	Minimum Allowed Measured Infiltration Rate for Meeting Flow Control, <u>RunoffWater Quality</u> Treatment, and LID Performance Standards (in/hr)
Infiltration Trenches	5	5
Drywells	5	5
Bioretention without underdrain	<u>0.30-6</u>	<u>0.30-6</u>
Bioretention with underdrain	0.3	No minimum
Rain Gardens	0.3	Not applicable (only for On-site List Approach)
Permeable Pavement	0.3	0.3
Perforated Stub-out Connections	0.3	Not applicable (only for On-site List Approach)
Infiltration Basins	Not applicable	0.6
Infiltration Chambers	Not applicable	0.6

Step 4: Determine Design Infiltration Rate

The measured infiltration rate determined in Step 3 shall be reduced using correction factors to account for site variability and the number of tests conducted, uncertainty of the test method, and potential for long-term clogging due to siltation and bio-buildup. The corrected infiltration rate is considered the long-term or design infiltration rate and is used for all BMP sizing calculations. Methodology for determining correction factors is provided in the Ecology Manual, Volume III, Section 3.3.6 Appendix G.

Infiltration BMPs are generally not appropriate for sites that have a design infiltration rate less than 0.3 inches per hour. Project sites with infiltration rates lower than those identified in Table 5.5 may be used for infiltration of stormwater only with Kitsap County approval on a case-by-case basis.

Step 5: Conduct Groundwater Monitoring, Receptor Characterization, Mounding and Seepage Analysis, and Infiltration Testing for Permeable Pavements Surfaces ~~Acceptance Testing~~ (as applicable)

The licensed professional shall provide recommendations for, and analysis of, groundwater monitoring, receptor characterization, mounding and seepage analysis, and ~~acceptance~~ infiltration testing. See the minimum requirements listed in

. As an exception, all permeable pavement ~~facilities and surfaces~~BMPs are required to perform ~~specific infiltration acceptance~~ testing per [BMP T5.15 in Volume V, Chapter 5 of the Ecology Manual](#). At a minimum, the ~~acceptance-infiltration~~ testing shall demonstrate that the infiltration ~~facility~~BMP performs at or above the design infiltration rate.

Step 6: Evaluate use of infiltration to meet minimum requirements

If infiltration is considered feasible based on the above steps, evaluate the feasibility of specific infiltration BMPs when selecting for On-site Stormwater Management ([Volume II, Section 5.3.3](#)), ~~Runoff Treatment~~Water-Quality ([Volume II, Section 5.3.4](#)), and Flow Control ([Volume II, Section 5.3.5](#)).

If the results of the subsurface investigation, infiltration testing, groundwater monitoring, infiltration receptor characterization, groundwater mounding, and/or seepage analysis indicate that adverse conditions could occur, as determined by a licensed professional, the infiltration ~~facility~~BMP shall not be built. Groundwater elevation data shall be used to evaluate the bottom of the ~~facility~~BMP against the vertical separation requirements to determine infiltration feasibility.

5.3.3 Select BMPs for On-site Stormwater Management

If MR #5: On-site Stormwater Management is triggered, it can be met by using the List approach or the LID Performance Standard approach. See Volume I, Chapter 4.2.5 for a detailed discussion of these approaches and their applicability based on project size and thresholds.

For both approaches, selection of BMPs shall build upon site assessment and planning information described in Volume I, Chapter 2 and the feasibility analysis described above in [Volume II, Sections 5.3.1 and 5.3.2](#). If the project triggers ~~Minimum Requirement~~MR #7: Flow Control and MR #6: Runoff Treatment requirements in addition to On-site Stormwater Management Requirements, see [Volume II, Sections 5.3.4 and 5.3.5](#) for additional discussion of BMP selection.

5.3.3.1 On-site List Approach

If the MR #5—: On-site Stormwater Management Requirement is triggered (see Volume I, Section 4.2.5) and the On-site List Approach is selected as the method for compliance, follow the steps presented below to select the appropriate BMP(s) for a given project.

Step 1: Determine if Dispersion and Infiltration are Feasible

~~See~~Refer to [Volume II, Sections 5.3.1 and 5.3.2](#).

Step 2: Calculate Areas by Surface Type

For each project type, divide the project area into lawn and landscape areas, roof areas, and other hard surface areas (i.e., driveways, walkways, sidewalks, etc.) with distinct drainage pathways.

Step 3: Identify the Applicable On-site List

Identify whether List #1, List #2A, [List #2B](#), or List #3 applies to the project based on the minimum requirements that are triggered. See Volume I, Section 4.2.5 for details on determining which list shall be applied.

Step 4: Evaluate BMPs for Each Surface Type in Order

The On-site BMP lists provided in Volume I, Section 4.2.5 include potential On-site BMPs for different surface types (lawn and landscape, roofs, and other hard surfaces) as identified in Step 2-~~above~~. For each surface type, the BMPs ~~must~~shall be considered in the order listed and the first BMP considered feasible ~~must~~shall be used.

~~See~~Refer to the [Volume II](#), Section 5.4 for additional requirements that may affect the design and placement of BMPs on the site.

5.3.3.2 On-site Performance Standard

If the MR #5—: On-Site Stormwater Management is triggered and the LID Performance Standard is the method used for compliance, follow the steps presented below to select the appropriate BMP(s) for a given project.

Step 1: Determine if Dispersion and Infiltration are Feasible

~~See~~Refer to [Volume II](#), Sections 5.3.1 and 5.3.2.

Step 2: Select BMP(s)

Select a BMP, or multiple BMPs, to meet the LID Performance Standard. Refer to [Volume II](#), Section 5.4 ~~of this volume~~ for BMP applicability, site suitability, and design criteria.

Step 3: Model BMP design

Model the selected BMPs to determine the required sizing to meet the LID Performance Standard using approved hydrologic modeling methods (see [Volume III, Section 2.6 in the Ecology Manual](#)).

5.3.4 Select BMPs for [RunoffWaterQuality](#) Treatment

For projects that trigger MR #6: Runoff Treatment (see Volume I, Section 4.2.6), this section describes the step-by-step process for selecting the type of treatment BMPs that apply to individual projects [for a TDA within the project](#), as well as the physical site features that can impact BMP selection. This section provides detailed information about BMP selection for the following [runoffwater-quality](#) treatment performance goals: oil control, phosphorus, enhanced, and basic.

[This section also applies to projects that require runoff treatment prior to infiltration. See Site Suitability Criteria \(SSC\)-6 Soil Physical and Chemical Suitability in Volume V, Section 5.6 in the Ecology Manual. If the project proposes the use of Underground Injection Control \(UIC\), see also Volume I, Section 4.13 in the Ecology Manual for further details on source control and runoff treatment requirements pertaining to UICs.](#)

[Water Quality Runoff](#) Treatment BMPs located upstream of Flow Control BMPs can be designed as on-line or off-line BMPs, as follows:

- **On-line BMPs** – Runoff flow rates in excess of the water quality design flow rate can be routed through the on-line [Water Quality Runoff](#) Treatment BMP provided that the BMP is sized sufficiently to treat the influent flows to the required level and that velocities are not high enough to resuspend sediments.
- **Off-line BMPs** – Runoff flow rates in excess of the water quality design flow rate may be bypassed around the off-line [Water Quality Runoff](#) Treatment BMP. Where feasible, off-line BMPs are required to prevent resuspension and washout of accumulated sediments during storm events. During bypass events, the BMP shall continue to receive and treat all flows up to and including the water quality design flow rate. Only those flows higher than the water quality design flow rate shall be allowed to bypass around the BMP.

In most cases, the engineer may choose whether to design [Water Quality Runoff](#) Treatment BMPs as on-line or off-line systems, provided they are sized sufficiently to provide the required treatment for the influent flows. However, oil/water separators shall be designed as off-line BMPs in all cases. [Water Quality Runoff](#) Treatment BMPs located downstream of Flow Control BMPs are generally considered to be off-line systems, since the influent flows are moderated by the Flow Control BMPs.

Follow the steps [presented in this section below](#) and in [Figure 5.2](#) ~~Figure 5.2~~ to select the appropriate [Water Quality Runoff](#) Treatment BMPs for ~~a projects~~ that triggers MR #6 [or require runoff treatment prior to infiltration](#). In addition, MR #5: On-site Stormwater Management and MR #7 ~~—~~; Flow Control Requirements may apply ([refer to see Volume II, Section 5.3.3 and Section 5.3.5](#), respectively).

Figure 5.2. ~~Treatment Facility BMP~~ Selection Flow Chart

Step 1: *Determine the Receiving Waters and Pollutants of Concern* [Based on Off-Site Analysis](#)

When identifying the receiving waters and downstream conveyance as part of the minimum requirement determination, specific pollutants of concern that the project must mitigate shall be determined. Such pollutants of concern could be identified in a Watershed or Basin Plan, a Water Clean-up Plan, a Ground Water Management Plan (Wellhead Protection Plan), a Lake Management Plan, or similar. See Volume I, Section 3.2 for further discussion.

An analysis of the proposed land use(s) of the project shall also be used to determine the stormwater pollutants of concern. See [Volume III, Chapter 1 in the Ecology Manual](#) ~~Volume V, Chapter 2 of the Ecology Manual~~ for further discussion on this.

Step 2: [Determine if](#) ~~Select an Oil Control BMP if Oil Control is Required~~

The use of oil control devices and [facilities-BMPs](#) is dependent upon the specific land use proposed for development. The Oil Control ~~Menu~~ [BMP Options](#) (see [Volume III, Section 1.2 in the Ecology Manual](#)) applies to projects that have “high-use sites.” High-use sites are those that

typically generate high concentrations of oil due to high traffic turnover or the frequent transfer of oil. High-use sites include:

- An area with commercial or industrial uses subject to an expected average daily traffic (ADT) count equal to or greater than 100 vehicles per 1,000 square feet of gross building area.

Note: Gasoline stations, with or without small food stores, will likely exceed the high-use site threshold.

- An area of a commercial or industrial site subject to petroleum storage and transfer in excess of 1,500 gallons per year, not including routinely delivered heating oil.

Note: The petroleum storage and transfer criterion is intended to address regular transfer operations such as gasoline service stations, not occasional filling of heating oil tanks.

- An area of a commercial or industrial site subject to parking, storage or maintenance of 25 or more vehicles that are over 10 tons gross weight (trucks, buses, trains, heavy equipment, etc.).

Note: In general, all-day parking areas are not intended to be defined as [high-use/high use sites](#), and shall not require an oil control [facility/BMP](#).

- A road intersection with a measured ADT count of 25,000 vehicles or more on the main roadway and 15,000 vehicles or more on any intersecting roadway, excluding projects proposing primarily pedestrian or bicycle use improvements.

Note: The traffic count can be estimated using information from “Trip Generation,” published by the Institute of Transportation Engineers, or from a traffic study prepared by a professional engineer or transportation specialist with experience in traffic estimation. See [the Institute of Transportation Engineers: www.ite.org](#).

The land uses below may have areas that fall within the definition of “high-use sites” and require oil control treatment. Further, these land uses require special attention to the oil control treatment selected. [Refer to See Volume III, Chapter 1 in the Ecology Manual](#) for more details:

- Industrial machinery and equipment, and railroad equipment maintenance areas
- Log storage and sorting yards
- Aircraft maintenance areas
- Railroad yards
- Fueling stations
- [Vehicle maintenance and repair sites](#)
- [Junkyards and areas with vehicle recycling operations](#)
- Construction businesses (paving, heavy equipment storage and maintenance, storage of petroleum products)

Note: All stormwater runoff from hard surface areas subject to motor vehicle traffic shall flow through a spill control (SC-type) oil/water separator prior to surface discharge off-site. See [Volume III and Volume IV of the Ecology Manual](#) for additional requirements. Spill control requirements are separate from this treatment requirement.

If oil control is required for the site, ~~refer to see~~ the General [BMP Design Requirements](#) in [Volume V, Chapter 1 of the Ecology Manual](#). The general requirements may affect the design and placement of ~~facilities~~ [BMPs](#) on the site (e.g., flow splitting). Then see [Volume V, Chapter 13 of the Ecology Manual](#) for guidance on the proper selection of options and design details [for oil and water separator BMPs](#).

[Step 3: Determine if it is Practicable to Provide Runoff Treatment by Infiltrating into the Native Soil](#)

[Due to the hydrologic benefits of infiltration, Kitsap County recommends evaluating whether it is practicable to provide runoff treatment by infiltrating into the site's native soils before considering other Runoff Treatment BMPs. If runoff treatment by infiltrating into the native soil is practicable, it has the advantage that it is presumed to meet the Phosphorus, Enhanced, and Basic Treatment Performance Goals.](#)

[The guidance in Volume V, Chapter 5 of the Ecology Manual shall be followed for designing infiltration BMPs. Volume V, Section 5.6 \(Site Suitability Criteria\) in the Ecology Manual details the site conditions that shall be met for infiltration to be practicable for the site, and includes conditions specific to using the native soil for runoff treatment. Runoff treatment may be provided by infiltrating into the native soil if the conditions below the infiltration BMP meet the criteria for Runoff Treatment per Volume V, Section 5.6 in the Ecology Manual.](#)

[Most infiltration BMPs should be preceded by a pretreatment BMP to reduce the occurrence of plugging. Some infiltration BMPs have pretreatment integrated into the BMP, such as permeable pavement and bioretention, and therefore it is not necessary to provide additional pretreatment prior to infiltration. Any Basic Treatment BMPs, or detention ponds, vaults, or tanks designed to meet flow control requirements, can also be used for pretreatment. If an oil/water separator is necessary for oil control, it could also function as the pre-settling basin as long as the influent suspended solids concentrations are not high. However, frequent inspections are necessary to determine when accumulated solids exceed the 6-inch depth at which clean-out is recommended \(See Volume V, Appendix V-A: BMP Maintenance Tables in the Ecology Manual\).](#)

[If infiltration is planned, also see the guidance in Volume V, Chapter 1 General BMP Design and Volume V, Appendix V-A in the Ecology Manual. This guidance may affect the design and placement of infiltration BMPs on the site.](#)

[Infiltration through soils that do not meet the criteria for runoff treatment per Volume V, Section 5.6 in the Ecology Manual is allowable as a Flow Control BMP only. Use of infiltration through such soils is acceptable provided the appropriate type of Runoff Treatment BMP \(Enhanced, Phosphorus, or Basic\) is provided as directed in the following steps.](#)

[*If it is practicable to provide runoff treatment by infiltrating into the native soil, select and apply a Pretreatment BMP and an infiltration BMP. You have completed the Runoff Treatment selection process.*](#)

[If it is not practicable to provide Runoff Treatment by infiltrating into the native soil, proceed to Step 4.](#)

Step 43: [Determine if Select a Phosphorus Treatment BMP if Phosphorus Treatment is Required](#)

The plans, ordinances, and regulations identified in Step 1 and in Volume I, Section 3.2 are a good reference to help determine if the subject site is in an area where phosphorus control is required.

Kitsap Public Health District (KPHD) conducts regular lake sampling and has determined that Kitsap Lake and Long Lake are phosphorus limited. Therefore, Phosphorus treatment is required for project sites draining into these receiving water bodies. Consult with KPHD to see if any other phosphorus limited receiving bodies have been identified.

If phosphorus control is required, select and apply a phosphorus treatment [facilityBMP](#). Refer to the Phosphorus Treatment [BMP OptionsMenu](#) in [Volume III, Section 1.2 of the Ecology Manual](#). [This section of the Ecology Manual includes options for individual BMPs and Treatment Trains for Phosphorus Treatment \(see Volume III, Section 1.2 of the Ecology Manual\).](#) Select an option [from the menu](#) after reviewing the applicability and limitations, site suitability, and design criteria of each for compatibility with the site. If you have selected a phosphorus treatment [facilityBMP](#), [refer to see](#) the General Requirements in [Volume V, Chapter 1 of the Ecology Manual](#), as they may affect the design and placement of the [BMPfacility](#) on the site.

[Note](#): Project sites subject to the Phosphorus Treatment requirement could also be subject to the Enhanced Treatment requirement (see Step 4). In that event, apply a [facility-BMP](#) or a treatment train that is listed in both the Enhanced Treatment Menu and the Phosphorus Treatment Menu.

Step 45: [Determine if Select an Enhanced Treatment BMP if Enhanced Treatment is Required](#)

Except where specified under Step [65](#), Enhanced Treatment for reduction of dissolved metals is required for the following project sites that:

1. [Discharge directly to fresh waters or conveyance systems tributary to fresh waters designated for aquatic life use or that have an existing aquatic life use; or](#)
- 1.2. [Discharge to conveyance systems that are tributary to fresh waters designated for aquatic life use or that have an existing aquatic life use; or](#)
3. [Infiltrate stormwater Use infiltration strictly for flow control — not treatment — and the discharge is within ¼ mile of a fresh water designated for aquatic life use or that has an existing aquatic life use.](#)

[The types of project sites are:](#)

- Industrial project sites
- Commercial project sites
- Multi-family residential project sites

- High Annual Average Daily Traffic (AADT) roads as follows:
 - Within Urban Growth Areas:
 - Fully controlled and partially controlled limited access highways with AADT counts of 15,000 or more.
 - All other roads with an AADT count of 7,500 or greater.
 - Outside of Urban Growth Areas:
 - Roads with an AADT of 15,000 or greater unless the site discharges to a 4th Strahler order stream or larger;
 - Roads with an AADT of 30,000 or greater if the site discharges to a 4th Strahler order stream or larger (as determined using 1:24,000 scale maps to delineate stream order).

Any areas of the above-listed project sites that are identified as subject to Basic Treatment requirements (see Step [65](#)) are not also subject to Enhanced Treatment requirements. **For developments (or TDAs)** with a mix of land use types, the Enhanced Treatment requirement shall apply when the runoff from the areas subject to the Enhanced Treatment requirement comprises 50% or more of the total runoff **from the development (or TDA)**.

If Enhanced Treatment is required for the site, see the Enhanced Treatment BMP Options in Volume III, Chapter 1 of the Ecology Manual. These options include individual Enhanced Treatment BMPs and Treatment Trains for Enhanced Treatment (see Volume III, Chapter 1 of the Ecology Manual).

Step [65](#): Select a Basic Treatment BMP

Note that if an Enhanced Treatment BMP or a Phosphorus Treatment BMP have been applied, an additional Basic Treatment BMP is not required. Phosphorus Treatment and Enhanced Treatment BMPs meet both the Basic Treatment Performance Goal as well as their own respective Performance Goals.

The Basic Treatment Performance Goal

Basic Treatment BMPs are intended to achieve 80% removal of total suspended solids for influent concentrations that are greater than 100 mg/l, but less than 200 mg/l. For influent concentrations greater than 200 mg/l, a higher treatment goal may be appropriate. For influent concentrations less than 100 mg/l, the BMPs are intended to achieve an effluent goal of 20 mg/l total suspended solids (TSS).

The Basic Treatment Performance Goal applies to the water quality design storm volume or flow rate, whichever is applicable. The incremental portion of runoff in excess of the water quality design storm volume or flow rate can be routed around the BMP (creating an off-line Runoff Treatment BMP), or can be passed through the BMP (creating an on-line Runoff Treatment BMP) provided a net TSS reduction is maintained. Ecology encourages the design and operation of Runoff Treatment BMPs that engage a bypass at flow rates higher than the water quality design flow rate as long as the reduction in TSS loading exceeds that achieved with

initiating bypass at the water quality design flow rate. Note that wetpool BMPs are always designed to be on-line. The Basic Treatment Performance Goal assumes that the BMP is treating stormwater with a typical particle size distribution. For a description of a typical particle size distribution, see Ecology's *Technical Guidance Manual for Evaluating Emerging Stormwater Treatment Technologies* (Ecology 2018).

Basic Treatment is required in the following circumstances:

When is Basic Treatment Required?

- Areas that must provide Phosphorus Treatment BMPs or Enhanced Treatment BMPs do NOT have to provide additional Basic Treatment BMPs to meet the Basic Treatment Performance Goal.
- If Phosphorus Treatment BMPs or Enhanced Treatment BMPs are not provided, Basic Treatment BMPs are required before discharging runoff off site through either infiltration or surface flow.
- For developments (or TDAs) with a mix of land use types, Basic Treatment BMPs are required when the runoff from the areas subject to the Basic Treatment Performance Goal comprises 50% or more of the total runoff from the development (or TDA).
- ~~Project sites that discharge to the ground, unless:~~
- ~~The soil suitability criteria for infiltration treatment are met (see Volume III, Chapter 3 of the Ecology Manual), and alternative pre-treatment is provided (See Volume V, Chapter 6 of the Ecology Manual), or~~
- ~~The project site uses infiltration strictly for flow control — not treatment — and the discharge is within ¼ mile of a phosphorus-sensitive lake (use the Phosphorus Treatment Menu), or~~
- ~~The project site is industrial, commercial, multi-family or a high AADT (consistent with the Enhanced Treatment type thresholds listed above) and is within ¼ mile of a fresh water designated for aquatic life use or that has an existing aquatic life use (use the Enhanced Treatment Menu).~~
- ~~Residential projects not otherwise needing phosphorus control in Step 3.~~
- ~~Project sites discharging directly (or indirectly through a municipal separate storm sewer system) to Basic Treatment Receiving Waters listed in Appendix I-C of Volume I of the Ecology Manual.~~
- ~~Project sites that drain to fresh water that is not designated for aquatic life use, and does not have an existing aquatic life use; and project sites that drain to waters not tributary to waters designated for aquatic life use or that have an existing aquatic life use.~~
- ~~Landscaped areas of industrial, commercial, and multi-family project sites, and parking lots of industrial and commercial project sites, dedicated solely to parking of employees' private vehicles that do not involve any other pollution-generating sources (e.g., industrial activities, customer parking, storage of erodible or leachable material, wastes or chemicals). For developments with a mix of land use types, the Basic Treatment requirement shall apply when the runoff from the areas subject to the Basic Treatment requirement comprises 50% or more of the total runoff.~~

Refer to the Basic Treatment BMP Options Menu in Volume III, Section 1.2 of the Ecology Manual. Select an option from the list menu after reviewing the applicability and limitations, site suitability, and design criteria of each for compatibility with the site.

After selecting a Basic Treatment [BMP facility](#), ~~refer to~~[see](#) the General Requirements in [Volume V, Chapter 1 of the Ecology Manual](#).

5.3.5 Select BMPs for Flow Control

If MR #7: Flow Control is triggered, follow the steps [listed in this section presented below](#) to select the appropriate Flow Control BMPs for a given project [\(or a TDA within the project\)](#). In addition, MR #5: ~~—~~ On-site Stormwater Management and MR #6: Runoff Treatment may apply. ~~Refer to~~[See Volume II](#), Sections 5.3.3 and 5.3.4 for additional information.

Step 1: Determine if Dispersion and Infiltration are Feasible

~~See~~[Refer to Volume II](#), Section 5.3.1 and Section 5.3.2.

Step 2: Determine if [Runoff Water Quality](#) Treatment requirements also apply

If MR #6: ~~—~~ Runoff Treatment also applies, look for opportunities to use Flow Control BMPs that can also meet treatment requirements (see [Volume II](#), Section 5.4).

Step 3: Select Flow Control BMP(s)

Select a Flow Control BMP or multiple BMPs. Refer to [Volume II](#), Section 5.4 for applicability, site ~~—~~ suitability, and design criteria. Select Flow Control BMPs that best integrate with On-site Stormwater Management and [Runoff Water Quality](#) Treatment to the extent feasible.

5.4 BMP Design

This section presents BMP design information for approved BMPs for meeting MR #5: ~~—~~ On-site Stormwater Management, MR #6: ~~—~~ Runoff Treatment, and MR #7: ~~—~~ Flow Control. On-site Stormwater Management and Flow Control BMPs may also be used to help satisfy MR #8: ~~—~~ Wetlands Protection, where applicable ([see Volume I, Section 4.2.8 of this manual](#)).

~~For each BMP, the information provided below is organized into separate sub-sections for BMP description, discussion of performance mechanisms, applications and limitations (including which minimum requirements can be fully or partially satisfied by the given BMP), site considerations, design information, minimum construction requirements, and operation and maintenance (O&M) requirements.~~ The remainder of this section details [requirements for runoff treatment prior to infiltration BMPs; requirements for BMPs classified as UICs; and BMP-specific design standards, requirements, and guidelines.](#) ~~The BMP-specific design guidance is generally organized into sub-sections for BMP description, discussion of performance mechanisms, applications and limitations (including which minimum requirements can be fully or partially satisfied by the given BMP), site considerations, design information, minimum construction requirements, and operation and maintenance (O&M) requirements.~~ [Refer to Volume III of the Ecology Manual for additional details on Flow Control BMP design and Volume V of the Ecology Manual for additional details on Water Quality Treatment BMP design.](#) [Refer to the LID Technical Guidance Manual for Puget Sound for additional details on On-site Stormwater Management BMPs \(referred to as “LID BMPs” in that manual\).](#) Finally, refer to Chapter 4 of

Volume II of this manual for conveyance system design requirements, including design of bypass systems for off-line BMPs.

See the following additional references for additional design guidelines and requirements:

- Volume V of the Ecology Manual: Provides additional details on Flow Control and Runoff Treatment BMP design.
- Volume III, Chapter 2 of the Ecology Manual: Provides Modeling Your BMPs in the Ecology Manual for guidance on modeling Runoff Treatment and Flow Control BMPs.
- LID Technical Guidance Manual for Puget Sound (LID Technical Guidance Manual) (Hinman and Wulkan, 2012): Provides additional details on On-site Stormwater Management BMPs (referred to as “Integrated Management Practices” in that manual).
- Volume II, Chapter 4: Provides conveyance system design requirements, including design of bypass systems for off-line BMPs.

In the event of conflicts between the LID Technical Guidance Manual and the Ecology Manual, the Ecology Manual supersedes, and its guidance shall be followed.

Pretreatment

Pre-settling shall be evaluated for most BMPs to protect BMPs from excessive siltation and debris. Pretreatment is required for some Runoff Treatment BMPs, as described in the individual BMP sections (where applicable). Beyond the requirements provided below, pre-settling and pretreatment shall be considered wherever a Basic Treatment BMP or the receiving water may be adversely affected by non-targeted pollutants (e.g., oil), or may be overwhelmed by a heavy load of targeted pollutants (e.g., suspended solids).

Runoff Treatment Prior to Infiltration BMPs

A pretreatment BMP to remove a portion of the influent suspended solids should precede all infiltration BMPs. This is to reduce potential plugging of the soils and prolong the life of the infiltration BMP. Use either a basic treatment BMP, as described in Volume III, Section 1.2 of the Ecology Manual, or a pretreatment BMP as described in Volume V, Chapter 9 of the Ecology Manual. The lower the influent suspended solids loading to the infiltration BMP, the longer the infiltration BMP can infiltrate the desired amount of water, and the longer interval between maintenance activity.

In BMPs such as BMP T7.20: Infiltration Trenches where a reduction in infiltration capability can have significant maintenance or replacement costs, selection of a reliable pretreatment or basic treatment BMP prior to the infiltration BMP with high solids removal capability is preferred. For infiltration BMPs that allow easier access for maintenance and less costly maintenance activity (e.g., BMP T7.10: Infiltration Basins with gentle side slopes), there is a trade-off between using a pretreatment or basic treatment BMP with a higher solids removal capability and a device with a lower capability. Generally, basic treatment BMPs are more capable at solids removal than pretreatment BMPs. Though basic treatment BMPs may be higher in initial cost and space demands, the infiltration BMP should have lower maintenance costs.

BMPs Classified as Underground Injection Controls (UICs)

[If the proposed design includes an infiltration BMP that is classified as an UIC, the design shall ensure compliance with the UIC program as well as any other applicable regulatory requirements. UIC Wells include subsurface infiltration systems that are used to discharge fluids from the ground surface into the subsurface \(e.g., drywells, infiltration trenches with perforated pipe, storm chamber systems with the intent to infiltrate\) \(See Volume I, Section 2.14 of the Ecology Manual\).](#)

5.4.1 Post Construction Soil Quality and Depth

5.4.1.1 BMP Description

[Post Construction Soil Quality and Depth \(BMP T5.13 in Volume V, Chapter 11 of the Ecology Manual\) requires that](#) Site soils shall meet minimum quality and depth requirement at project completion. Requirements may be achieved by either retaining and protecting undisturbed soil or restoring the soil (e.g., amending with compost) in disturbed areas.

5.4.1.2 Performance Mechanism

Naturally occurring (undisturbed) soil and vegetation provide important stormwater functions ~~including:~~[including](#) water infiltration; nutrient, sediment, and pollutant adsorption; sediment and pollutant biofiltration; water interflow storage and transmission; and pollutant decomposition. These functions are largely lost when development strips away native soil and vegetation and replaces it with minimal topsoil and sod. Not only are these important stormwater functions lost, but such landscapes themselves become pollution generating pervious surfaces (PGPS) due to increased use of pesticides, fertilizers and other landscaping and household/industrial chemicals, the concentration of pet wastes, and pollutants that accompany roadside litter.

Establishing soil quality and depth regains greater stormwater functions in the post-development landscape, provides increased treatment of pollutants and sediments that result from development and habitation, and minimizes the need for some landscaping chemicals, thus reducing pollution through prevention.

5.4.1.3 Applications and Limitations

Establishing a minimum soil quality and depth is not the same as preservation of naturally occurring soil and vegetation. However, establishing a minimum soil quality and depth will provide improved on-site management of stormwater flow and water quality.

Soil organic matter can be attained through numerous materials such as compost, composted woody material, biosolids, and forest product residuals. It is important that the materials used for this BMP be appropriate and beneficial to the plant cover to be established. Likewise, it is important that imported topsoil improves soil conditions and does not have an excessive percent of clay fines. This BMP can be considered infeasible on till soil with slopes greater than 33%.

Soil amendments can also be used to help achieve on-site stormwater management and flow control standards when integrated into a dispersion BMP. [See Table 5.6 for a summary of minimum requirements that can be met, partly or in full, through the use of this BMP.](#) Refer to [Volume II, Section 5.4.4 below in this chapter](#) for additional information on dispersion BMPs.

[Table 5.6. Post Construction Soil Quality and Depth Applicability](#)

BMP	MR #5: On-site Stormwater Management		MR #6: Runoff Treatment				MR #7: Flow Control
	List	LID Performance Standard	Basic	Enhanced	Oil Control	Phosphorus	
Post Construction Soil Quality and Depth	X	X					X

5.4.1.4 **Site Considerations**

At project completion, meet soil amendment requirements for all areas subject to clearing, grading, or compaction that have not been covered by a hard surface, incorporated into a [BMP drainage facility](#), or engineered as structural fill or slope. Only the areas where existing vegetation and/or soil are disturbed or compacted are required to be restored.

5.4.1.5 **Design Information**

The soil quality design requirements ~~can~~ shall be met by using one of the [following](#) four options ~~listed below~~. [Refer to the Building Soil manual \(Stenn et al. 2018\) or website \(www.buildingsoil.org\) for additional details on these options:](#)

2. Retain and Protect Undisturbed Soil:
 - Leave undisturbed vegetation and soil, and protect from compaction by fencing and keeping materials storage and equipment off these areas during construction.
 - For all areas where soil or vegetation are disturbed, use option 2, 3, or 4.
3. Amend Soil:

Amend existing site topsoil or subsoil either at default “pre-approved” rates, or at custom calculated rates to meet the soil quality guidelines based on engineering tests of the soil and amendment. The default pre-approved rates are:

 - In planting beds: place 3 inches of compost and till in to an 8-inch depth.
 - In turf areas: place 1.75 inches of compost and till in to an 8-inch depth.
 - Scarify (loosen) subsoil 4 inches below amended layer to produce a 12-inch depth of un-compacted soil.
 - After planting: apply 2 to 4 inches of arborist wood chip or compost mulch to planting beds. Coarse bark mulch may be used but has lower benefits to plants and soil. Do not use fine bark because it can seal the soil surface.
4. Stockpile Soil:
 - Stockpile existing topsoil during grading and replace it prior to planting. Amend stockpiled topsoil if needed to meet the organic matter or depth requirements either

at the default “pre-approved” rate or at a custom calculated rate (~~refer to~~[see](#) the Building Soil manual (Stenn et al. ~~2018~~[2012](#)) or website (www.buildingsoil.org), for custom calculation method). Scarify subsoil and mulch planting beds, as described in option ~~(2)~~[above](#).

5. Import Soil:

- Import topsoil mix of sufficient organic content and depth to meet the requirements. Imported soils shall not contain excessive clay or silt fines (more than 5% passing the No. 200 sieve) because that could restrict stormwater infiltration. The default pre-approved rates for imported topsoils are:
 - For planting beds: use a mix by volume of 35% compost with 65% mineral soil to achieve the requirement of a minimum 8% (target 10%) organic matter by loss-on-ignition test.
 - For turf areas: use a mix by volume of 20% compost with 80% mineral soil to achieve the requirement of a minimum 4% (target 5%) organic matter by loss-on-ignition test.
 - Scarify subsoil and mulch planting beds, as described in option ~~2~~[above](#).

Note: More than one method may be used on different portions of the same site.

Areas meeting the design guidelines listed above and in [BMP T5.13 in Volume V, Chapter 11 of the Ecology Manual](#) can be modeled as “Pasture” rather than “Lawn” in an approved runoff model.

5.4.1.6 Minimum Construction Requirements

- Establish soil quality and depth toward the end of construction and once established, protect from compaction, such as from large machinery use, and from erosion.
- Plant vegetation and mulch the amended soil area after installation.
- Leave plant debris or its equivalent on the soil surface to replenish organic matter.
- Reduce and adjust, where possible, the use of irrigation, fertilizers, herbicides and pesticides, rather than continuing to implement formerly established practices.

5.4.1.7 Operations and Maintenance Requirements

Key maintenance considerations for compost-amended soils include the replenishment of soil media as needed (as a result of erosion) and addressing compacted, poorly draining soils. Site uses shall protect vegetation and avoid compaction.

The full benefits of compost-amended soils are realized when desired soil media depths are maintained, and soil compaction is minimized. Care shall be taken to prevent compaction of soils via vehicular loads and/or excessive foot traffic, especially during wet conditions.

[After installation, plant vegetation and mulch the amended soil area. Plant debris and its equivalent should be left on the soil surface to replenish organic matter. The use of irrigation, fertilizers, herbicide and pesticides should be reduced or adjusted, where possible, rather than continued implementation of formerly established practices.](#)

~~The Western Washington Low Impact Development Operation and Maintenance Guidance document (Ecology 2013) provides the recommended maintenance frequencies, standards, and procedures for compost-amended soils. The level of routine maintenance required and the frequency of corrective maintenance actions may increase for facilities prone to erosion due to site conditions such as steep slopes or topography tending to concentrate flows.~~

5.4.2 Better Site Design

5.4.2.1 BMP Description

~~Better Site Design (BMP T5.41 in Volume V, Chapter 2 of the Ecology Manual) incorporates fundamental hydrological concepts and stormwater management concepts that can be applied at the site design phase. Some of the benefits include that are:~~

- More ~~integration~~~~integrated~~ with natural topography,
- ~~Reinforcement~~~~Reinforce~~ ~~of~~ the hydrologic cycle,
- ~~Improved aesthetics~~~~More aesthetically pleasing~~, and
- ~~Potential for lower construction costs~~~~Often less expensive to build~~.

Specific site planning principles can help to locate development on the least sensitive portions of a site and accommodate residential land use while mitigating its impact on stormwater quality.

5.4.2.2 Performance Mechanism

Minimizing impervious surfaces, loss of vegetation, and stormwater runoff helps minimize alteration of flows and pollutant loadings in receiving water bodies.

5.4.2.3 Applications and Limitations

By applying the site planning principles described in ~~Volume II~~, Section 5.4.2.5 ~~below~~ and in Volume I, Chapter 2 during the project planning phase, the impacts ~~triggering that trigger~~ On-site Stormwater Management (MR #5), Runoff Treatment (MR #6), and Flow Control (MR #7) can be reduced or even eliminated.

5.4.2.4 Site Considerations

Refer to the detailed Site Assessment and Planning requirements in Volume I, Chapter 2 for site considerations that must be evaluated.

5.4.2.5 Design Information

~~BMP T5.41 in Volume V, Chapter 2 of the Ecology Manual~~ describes the guidelines and steps for Better Site Design, including:

- Define development envelope and protected areas;
- Minimize directly connected impervious areas through the use of permeable pavements, narrower roadways, shared driveways, on-site stormwater management BMPs that infiltrate on-site, etc.;
- Maximize permeability;

- Build narrower streets;
- Maximize choices for mobility; and
- Use drainage as a design element wherever possible.

5.4.3 Preserving Native Vegetation

5.4.3.1 BMP Description

Preserving native vegetation ([BMP T5.40 in Volume V, Chapter 2 of the Ecology Manual](#)) on-site to the maximum extent practicable will minimize the impacts of development on stormwater runoff. Preferably 65% or more of the development site shall be protected for the purposes of retaining or enhancing existing forest cover and preserving wetlands and stream corridors. [See Refer to Title 17 KCC](#) for native vegetation preservation where applicable.

5.4.3.2 Performance Mechanism

Forest and native growth areas allow rainwater to naturally percolate into the soil, recharging ground water for summer stream flows and reducing surface water runoff that creates erosion and flooding. Conifers can hold up to about 50% of all rain that falls during a storm. Twenty to ~~thirty percent~~30% of this rain may never reach the ground but evaporates or is taken up by the tree. Forested and native growth areas also may be effective as stormwater buffers around smaller developments.

5.4.3.3 Applications and Limitations

New development often takes place on tracts of forested land. In fact, building sites are often selected because of the presence of mature trees. However, unless sufficient care is taken and planning done, in the interval between buying the property and completing construction much of this resource may be destroyed. The property owner is ultimately responsible for protecting as many trees as possible, with their understory and groundcover. It takes 20 to 30 years for newly planted trees to provide the benefits for which trees are so highly valued.

On lots that are one acre or greater, preservation of 65% or more of the site in native vegetation will allow the use of full dispersion techniques presented in [Volume II](#), Section 5.4.4. Sites that can fully disperse are not required to provide runoff treatment or flow control ~~facilities~~BMPs. [See Table 5.7 for a summary of which minimum requirements this BMP can be used to fully or partially satisfy.](#)

Table 5.7. Preserving Native Vegetation [Applicability](#)

BMP	MR #5: On-site Stormwater Management		MR #6: Runoff Treatment				MR #7: Flow Control
	List	LID Performance Standard	Basic	Enhanced	Oil Control	Phosphorus	
Preserving Native Vegetation		X					X

5.4.3.4 Site Considerations

Review and characterize the existing site vegetation, per Volume I, Section 2.1.7, to identify valuable existing vegetation, like mature trees, that shall be preserved wherever feasible.

5.4.3.5 Design Information

Wherever feasible, designs shall incorporate the following with respect to preserved native vegetation areas:

- The preserved area shall be situated to minimize the clearing of existing forest cover, to maximize the preservation of wetlands, and to buffer stream corridors.
- The preserved area shall be placed in a separate tract or protected through recorded easements for individual lots.
- If feasible, the preserved area shall be located downslope from the building sites, since flow control and water quality are enhanced by flow dispersion through duff, undisturbed soils, and native vegetation.
- The preserved area shall be shown on all property maps and shall be clearly marked during clearing and construction on the site.

5.1.1.2 Minimum Construction Requirements

~~5.1.1.3 See [Volume I, Section 4.2.2 of the Ecology Manual](#).~~

5.4.3.6 Operations and Maintenance Requirements

Vegetation and trees shall not be removed from the natural growth retention area, except for approved timber harvest activities and the removal of dangerous or diseased trees.

5.4.4 Dispersion BMPs

5.4.4.1 BMP Description

Dispersion BMPs disperse runoff over vegetated pervious areas to provide flow control. The dispersion BMPs in this section include:

- Full dispersion ([BMP T5.30 in Volume V, Chapter 3 of the Ecology Manual](#))
- Downspout dispersion ([BMP T5.10B in Volume V, Chapter 3 of the Ecology Manual](#))
- Sheet flow dispersion ([BMP T5.12 in Volume V, Chapter 3 of the Ecology Manual](#))
- Concentrated flow dispersion ([BMP T5.11 in Volume V, Chapter 3 of the Ecology Manual](#))

[A site \(or an area of a site\) that applies full dispersion per BMP T5.30 in Volume V, Chapter 3 of the Ecology Manual consists of the following elements:](#)

- [An impervious \(or cleared\) area. The impervious \(or cleared\) area is the area that the design is mitigating for by using BMP T5.30 in Volume V, Chapter 3 of the Ecology Manual.](#)

- **A flow spreader.** Runoff from the impervious (or cleared) area may need to be routed through a flow spreader (see Volume V, Section 1.4.2 in the Ecology Manual), depending on the site layout and type of impervious surface, as further described in this section below.
- **A dispersion area.** This area defines the limits of the Full Dispersion BMP. The impervious (or cleared) area shall disperse into the preserved dispersion area.
 - The dispersion area shall be forest, native vegetation, or a cleared area depending on the site type. Details are provided for BMP T5.30 in Volume V, Chapter 3 of the Ecology Manual for what amount of vegetation the dispersion area shall contain based on site type.
 - If the dispersion area must be preserved as forest or native vegetation, it may be a previously cleared area that has been replanted in accordance with BMP T5.30 in Volume V, Chapter 3 of the Ecology Manual.
 - The dispersion area shall be situated to minimize the clearing of existing forest cover, to maximize the preservation of wetlands (though the wetland area and any streams and lakes do not count as part of the dispersion area), and to buffer stream corridors.
 - The dispersion area shall be protected through recorded easements for individuals lots or through protective covenants recorded against the property.
 - The dispersion area ~~should~~ shall be shown on ~~all~~ the property map site plans and ~~should~~ shall be clearly marked during clearing and construction on the site.
 - All trees within the dispersion area at the time of permit application shall be retained, aside from:
 - Dangerous or diseased trees, and
 - Approved timber harvest activities regulated under WAC Title 222. Class IV General Forest Practices that are conversions from timberland to other uses are not acceptable for the preserved area.
 - The dispersion area may be used for passive recreation and related facilities, including pedestrian and bicycle trails, nature viewing areas, fishing and camping areas, and other similar activities that do not require permanent structures. Cleared areas and areas of compacted soil associated with these areas and facilities shall not exceed eight percent of the dispersion area.
 - The dispersion area may contain utilities and utility easements, but not septic systems. For the purpose of this BMP, utilities are defined as potable and wastewater underground piping, underground wiring, and power and telephone poles.
- **A flow path through the dispersion area.** The length of the flow path from the impervious (or cleared) area through the dispersion area varies based on the site layout

and type of impervious surface, as described in this section. Regardless of the site layout and type of impervious surface, the flow path shall meet the following criteria:

- o The slope of the flow path shall be no steeper than 15% for any 20-foot reach of the flow path. Slopes up to 20% are allowed where flow spreaders are located upstream of the dispersion area and at sites ~~where~~ where vegetation can be established.
- o The flow paths from adjacent flow spreaders ~~must~~ shall be sufficiently spaced to prevent overlap of flows in the flow path area.

The dispersion of runoff shall not create flooding or erosion impacts.

5.4.4.2 Performance Mechanism

Dispersion of concentrated flows from driveways or other pavement through a vegetated pervious area attenuates peak flows by slowing entry of the runoff into the conveyance system, allowing for some infiltration, and providing some water quality benefits.

5.4.4.3 Applications and Limitations

Full dispersion can be utilized for runoff from impervious surfaces and cleared areas of project sites into areas preserved as forest, native vegetation, or cleared area. The site (or area of the site) that is applying full dispersion per this BMP shall be laid out to allow the runoff from the impervious (or cleared) surface to fully disperse into the preserved dispersion area. (i.e., have full access to and not be intercepted by pipe(s), ditch(es), stream(s), river(s), pond(s), lake(s), or wetland(s)). Projects that successfully apply full dispersion on all or a portion of their site will decrease effective impervious surfaces and may avoid triggering the TDA thresholds in Volume I, Section 4.2.7. development sites that protect at least 65% of the site in a forest or native condition.

The following limitations apply to this specific type of dispersion:

- Rural single family residential developments shall consider dispersion BMPs to minimize to the extent feasible effective impervious surface to less than 10% of the development site.
- Other types of development that retain 65% of the site in a forested or native condition may also use these BMPs to avoid triggering the flow control facility requirement.
- The preserved area may be a previously cleared area that has been replanted in accordance with native vegetation landscape specifications described for this BMP.
- The preserved area shall be situated to minimize the clearing of existing forest cover, maximize the preservation of wetlands (though wetland area, streams and lakes do not count toward the 65% forest or native condition area), and buffer stream corridors.
- The preserved area shall be placed in a separate tract or protected through recorded easements for individual lots.
- The preserved area shall be shown on all property maps and shall be clearly marked during clearing and construction on the site.
- All trees within the preserved area at the time of permit application shall be retained, aside from approved timber harvest activities regulated under WAC Title 222, except for Class IV General Forest Practices that are conversions from timberland to other uses, and the removal of dangerous or diseased trees.

- ~~The preserved area may be used for passive recreation and related facilities, including pedestrian and bicycle trails, nature viewing areas, fishing and camping areas, and other similar activities that do not require permanent structures, provided that cleared areas and areas of compacted soil associated with these areas and facilities do not exceed 8% of the preserved area.~~
- ~~The preserved area may contain utilities and utility easements, but not septic systems. Utilities are defined as potable and wastewater underground piping, underground wiring, and power and telephone poles.~~

~~See Volume V of the Ecology Manual, BMP T5.30 for further discussion on full dispersion applications and limitations.~~

Downspout dispersion may be used in all subdivision lots where downspout full infiltration, full dispersion, and bioretention/rain gardens are not feasible.

Use sheet flow dispersion for flat or moderately sloping (< 15% slope) surfaces such as driveways, sports courts, patios, roofs without gutters, lawns, pastures; or any situation where concentration of flows can be avoided.

Use concentrated flow dispersion in any situation where concentrated flow can be dispersed through vegetation.

~~See below which minimum requirements each dispersion BMP type can be used to either fully or partially satisfy. Dispersion BMPs can be used to meet on-site stormwater management, basic treatment, and flow control requirements (Table 5.8). See Volume V, Chapter 3, BMP T5.30 of the Ecology Manual for further discussion on full dispersion applications and limitations.~~

Table 5.8. Dispersion Applicability

BMP	MR #5: On-site Stormwater Management		MR #6: Runoff Treatment				MR #7: Flow Control
	List	LID Performance Standard	Basic	Enhanced	Oil Control	Phosphorus	
Full	X	X					X
Downspout	X	X	X ^a				X
Sheet Flow	X	X	X ^a				X
Concentrated Flow	X	X	X ^a				X

Notes:

- Meets basic runoff treatment requirements when additional requirements for Basic Filter Strip BMPs ([Volume II, Section 5.4.21](#)) are met.

5.4.4.4 Site Considerations

~~The dispersion area shall have a minimum area 6.5 times the area of the impervious surface draining to it. As discussed in the previous section, full dispersion can be utilized for runoff from impervious surfaces and cleared areas of development sites that protect at least 65% of the site~~

~~in a forest or native condition. Refer to~~ [See Volume V, Chapter 3, BMP T5.30 of the Ecology Manual](#) for ~~further full dispersion~~ [additional](#) site considerations for residential projects and public road projects.

The following are key considerations in determining the feasibility of dispersion BMPs for a particular site ([see Volume II, Section 5.3.1 for additional discussion of site requirements for dispersion](#)):

- Dispersion Flow Path – Dispersion BMPs generally require large areas of vegetated ground cover to meet flow path requirements and may be oftentimes infeasible in dense, urban settings.
- Erosion or Flooding Potential – Dispersion is not allowed in settings where the dispersed flows might cause erosion or flooding problems, either on-site or on adjacent properties.
- Site Topography – Dispersion flow paths are prohibited in and near certain sloped areas. [\(refer to flow path requirements in Section 5.3.1\).](#)

5.4.4.5 Design Information

~~For full dispersion design requirements for residential and public road projects, see~~ [See the Minimum Design Requirements for Residential Projects and Minimum Design Requirements for Public Road Projects in Volume V, Chapter 3, BMP T5.30 of the Ecology Manual. The same volume of the Ecology Manual also provides design requirements](#) [See also Volume V, Chapter 4, BMP T5.10B](#) for downspout dispersion ~~(BMP T5.10B)~~, [Volume V, Chapter 4, BMPT T5.10C in the Ecology Manual](#) for concentrated flow dispersion ~~(BMP T5.11)~~, and [Volume V, Chapter 3, BMP T5.12 in the Ecology Manual](#) for sheet flow dispersion ~~design requirements (BMP T5.12).~~

Flow path design requirements that are common to all dispersion BMPs ~~are listed below~~ [include the following](#):

- The vegetated flow path shall meet the requirements in [Volume II, Section 5.3.1](#) ~~Section 5.3.1~~ and shall consist of either undisturbed, well-established native landscape or lawn, or landscape or groundcover over soil that meets the Post Construction Soil Quality and Depth BMP requirements outlined in [Volume II, Section 5.4.11](#).
- To ensure that the groundcover is dense to help disperse and infiltrate flows and prevent erosion, the design plans shall specify that vegetation coverage of plants will achieve 90% coverage within one year.
- The flow path topography shall promote shallow sheet flow across a width of no less than 6 feet for dispersion points (i.e., splash blocks or rock pads) or the width of the dispersion device (i.e., trench or sheet flow transition zone).
- The dispersion flow path is not typically permitted within landslide-hazard areas as defined in [Title 19 KCC](#).
- The dispersion flow path is not typically permitted within a setback above a steep slope area ([Title 19 KCC](#)). The setback is calculated as 10 times the height of the steep slope area (to a 500-foot maximum setback). Dispersion within this setback may be feasible

provided a detailed slope stability analysis is completed by a licensed geotechnical engineer or hydrogeologist. The analysis shall determine the effects that dispersion would have on the steep slope area and adjacent properties.

- The dispersion flow path is not permitted within 100 feet of a contaminated site or landfill (active or closed).
- For sites with septic systems, the point of discharge to the dispersion device (e.g., splash block, dispersion trench) shall be down-gradient of the drainfield primary and reserve areas.

[See Table 5.1 for a summary of flow path requirements and see the Ecology Manual for detailed design guidance for each dispersion BMP. See Figure 4.1 in Volume II, Chapter 4 for dispersion trench design standards.](#)

[See BMP T5.11, BMP T5.12, and BMP T5.30 in Volume V, Chapter 5 of the Ecology Manual for guidance on Runoff Model Representation for concentrated flow dispersion, sheet flow dispersion, and full dispersion, respectively.](#)

5.4.4.6 Minimum Construction Requirements

Protect the dispersion flow path from sedimentation and compaction during construction. If the flow path area is disturbed during construction, restore the area to meet the Post Construction Soil Quality and Depth BMP requirements in [Volume II](#), Section 5.4.1, and establish a dense cover of lawn, landscape or groundcover.

5.4.4.7 Operations and Maintenance Requirements

Key maintenance considerations for dispersion BMPs include the maintenance of splash blocks (where used with downspout dispersion), trenches (where used with downspout dispersion), transition zones (where used with sheet flow dispersion), rock pads at discharge [points locations](#) (where used with concentrated flow dispersion), and the dispersal area. [See Volume V, Appendix V-A in the Ecology Manual for additional maintenance guidelines pertaining to all dispersion BMPs.](#)

~~The [Western Washington Low Impact Development Operation and Maintenance Guidance](#) document (Ecology 2013) provides the recommended maintenance frequencies, standards, and procedures for the different dispersion BMP types. The level of routine maintenance required and the frequency of corrective maintenance actions may increase for facilities prone to erosion due to site conditions such as steep slopes or topography tending to concentrate flows.~~

5.4.5 Rain Gardens

5.4.5.1 BMP Description

Rain gardens ([BMP T5.14 in Volume V, Chapter 11 of the Ecology Manual](#)) are non-engineered, shallow, landscaped depressions with compost-amended soils and adapted plants. The depressions pond and temporarily store stormwater runoff from adjacent areas. A portion of the influent stormwater passes through the amended soil profile and into the native soil beneath.

Stormwater that exceeds the storage capacity is designed to overflow to an adjacent drainage system.

5.4.5.2 Performance Mechanisms

While rain gardens cannot be used to achieve [runoffwater quality](#) treatment to satisfy MR #6: Runoff Treatment, some treatment is provided in the form of filtration, sedimentation, adsorption, uptake, and biodegradation, and transformation of pollutants by soil organisms, soil media, and plants. Rain gardens also provide some flow control in the form of detention, attenuation, infiltration, interception, evaporation, and transpiration ([Seattle 2016](#)).

5.4.5.3 Applications and Limitations

Rain gardens can be used to satisfy the On-site List Approach for MR #5: On-site Stormwater Management. They cannot be used to satisfy the LID Performance Standard Approach to MR #5, nor can they be used to satisfy MR #6: Runoff Treatment or MR #7: Flow Control. Bioretention may be used instead to meet all of these requirements (MR #5-7), as described further in [Volume II, Section 5.4.6](#) ~~below~~ [and as summarized in Table 5.9](#).

For projects eligible and electing to use List #1 (Volume I, Section 4.2.5), rain gardens are to be used to the extent feasible for runoff from roofs and other hard surfaces unless a higher priority BMP is feasible.

Infeasibility criteria for rain gardens are the same as for bioretention. [Please see](#) Bioretention Infeasibility Criteria in Appendix H ~~of this manual~~.

Although not required, installation by a landscaping company with experience in rain garden construction is highly recommended.

Rain gardens constructed with imported compost materials shall not be used within one-quarter mile of phosphorus-sensitive waterbodies. Preliminary monitoring indicates that new rain gardens can add phosphorus to stormwater. Therefore, they shall also not be used with an underdrain when the underdrain water would be routed to a phosphorus-sensitive receiving water.

Table 5.9 Rain Gardens [Applicability](#)

BMP	MR #5: On-site Stormwater Management		MR #6: Runoff Treatment				MR #7: Flow Control
	List	LID Performance Standard	Basic	Enhanced	Oil Control	Phosphorus	
Rain Gardens	X						

5.4.5.4 Site Considerations

See the LID Infeasibility Criteria (Appendix H) for site considerations associated with rain gardens, and [Volume II, Section 5.3.2](#) ~~above~~ for general infiltration feasibility criteria.

5.4.5.5 Design Information

Refer to [See BMP T5.14 in Volume V, Chapter 11 of the Ecology Manual](#) and the [Rain Garden Handbook for Western Washington \(Hinman et. al, 2013\)](#) for detailed design guidance on rain gardens, ~~including each of the following individual components of design:~~

- ~~• Contributing area~~
- ~~• Flow entrance~~
- ~~• Ponding area~~
- ~~• Compost amended or imported bioretention soil~~
- ~~• Subgrade~~
- ~~• Overflow~~
- ~~• Underdrains (not typically recommended for rain gardens)~~
- ~~• Plants~~
- ~~• Mulch~~

[See BMP T5.14 in Volume V, Chapter 11 of the Ecology Manual for guidance on Runoff Model Representation.](#)

5.4.5.6 Minimum Construction Requirements

To help prevent clogging and over-compaction of the subgrade, bioretention soils, or amended soils, do not excavate, place soil, or amend soil during wet or saturated conditions.

5.4.5.7 Operations and Maintenance Requirements

Refer to [See the Rain Garden Handbook for Western Washington \(HinmanWSU Extension, et al., 2013\)](#) [for tips on mulching, watering, weeding, pruning, and soil management.](#) [See the Maintenance section in BMP T5.14 in Volume V, Chapter 11 of the Ecology Manual for additional maintenance guidance.](#)

5.4.6 Bioretention Cells, Swales, and Planter Boxes

5.4.6.1 BMP Description

Bioretention areas ([BMP T7.30 in Volume V, Chapter 5 of the Ecology Manual](#)) are engineered, shallow, landscaped depressions, with a designed soil mix and plants adapted to the local climate and soil moisture conditions that receive stormwater from a contributing area.

The term, bioretention, is used to describe various designs using soil and plant complexes to manage stormwater, and can include:

- **Bioretention Cells** - Shallow depressions with a designed planting soil mix and a variety of plant material, including trees, shrubs, grasses, and/or other herbaceous plants. Bioretention cells may or may not have an underdrain and are not designed as a conveyance system.
- **Bioretention Swales** - Incorporate the same design features as bioretention cells; however, bioretention swales are designed as part of a system that can convey stormwater when maximum ponding depth is exceeded. Bioretention swales have relatively gentle side slopes and ponding depths that are typically 6 to 12 inches.

- Bioretention Planters and Planter Boxes - Designed soil mix and a variety of plant material including trees, shrubs, grasses, and/or other herbaceous plants within a vertical walled container usually constructed from formed concrete, but could include other materials. Planter boxes are completely impervious and include a bottom (must include an underdrain). Planters have an open bottom and allow infiltration to the subgrade. These designs are often used in ultra-urban settings.

The purpose of bioretention is to provide effective removal of many stormwater pollutants and provide reductions in stormwater runoff quantity and surface runoff flow rates. Where the surrounding native soils have adequate infiltration rates, bioretention can provide both Runoff Treatment and Flow Control. Where the native soils have low infiltration rates, underdrain systems can be installed and the bioretention BMP can still be used as a Runoff Treatment BMP. However, designs utilizing underdrains provide less Flow Control benefits.

Stormwater planters in the right of way require urban design and tailoring to street typology and context. NACTO Urban Street Stormwater Guide provides guidance for designing roadside stormwater planters.

See Typical Bioretention, Typical Bioretention w/Underdrain, Typical Bioretention w/Liner (Not LID), and Example of a Bioretention Planter figures in Volume V, Chapter 5 of the Ecology Manual for examples of various types of bioretention configurations.

Note: Ecology has approved use of certain manufactured treatment devices that use specific, high rate media for treatment. Such systems do not use bioretention soil mix and are not considered a bioretention BMP (even though marketing materials for these manufactured treatment devices may compare them to bioretention). See Volume II, Section 5.4.30 for more information on manufactured treatment devices. Ecology has approved use of certain patented treatment systems that use specific, high rate media for treatment. Such systems are not considered LID BMPs and are not options for meeting the requirements of MR #5. The Ecology approval can be used for MR #6—Runoff Treatment, where appropriate.

5.4.6.2 Performance Mechanism

Bioretention provides effective removal of many stormwater pollutants by passing stormwater through a soil profile that meets specified characteristics. Bioretention can also reduce stormwater runoff quantity and surface runoff flow rates significantly where the exfiltrate from the design soil is allowed to infiltrate into the surrounding native soils. Bioretention can be used as a primary or supplemental detention/retention system. Where the native soils have low infiltration rates, underdrain systems can be installed, and the facility BMP used to filter pollutants and detain flows. However, designs utilizing underdrains provide less flow control benefits.

5.4.6.3 Applications and Limitations

For projects electing to use List #2 of MR #5 (Volume I, SectionChapter 4.2.5), bioretention facilities BMPs shall be used to the extent feasible for runoff from roofs and other hard surfaces unless a higher priority BMP is feasible. Small projects that are only required to meet MR #1-5 may also use bioretention BMPsfacilities in place of rain gardens.

Because bioretention [BMPsfacilities](#) use an imported soil mix that has a moderate design infiltration rate, they are best applied for small drainages, and near the source of the stormwater generation whenever possible. Distributing bioretention cells throughout the project site (i.e., along roadways, in open space areas, on private properties, etc.) can significantly help achieve this goal.

Bioretention [BMPsfacilities](#) can, but are not required to fully meet the MR #6: Runoff Treatment standard to treat 91% of the stormwater runoff from pollution-generating surfaces (Volume I, [SectionChapter 4.2.6](#)). They can be sized to fully or partially meet the standard, and can be paired with other [Water QualityRunoff](#) Treatment BMPs as needed to fully satisfy the standard.

Bioretention [BMPsfacilities](#) that infiltrate into the ground can also serve a significant flow reduction function. They can, but are not required to fully meet the flow control duration standard of MR #7: Flow Control.

Bioretention constructed with imported composted material shall not be used within one-quarter mile of phosphorus-sensitive waterbodies if the underlying native soil does not meet the [sitesoil](#) suitability criteria for treatment in [Volume V, Section 5.6 of the Ecology Manual](#). Preliminary monitoring indicates that new bioretention [BMPsfacilities](#) can add phosphorus to stormwater. Therefore, they shall also not be used with an underdrain when the underdrain water would be routed to a phosphorus-sensitive receiving water.

Applications with or without underdrains vary extensively and can be applied in new development, redevelopment and retrofits. Typical applications include:

- Individual lots for rooftop, driveway, and other on-lot impervious surface.
- Shared facilities located in common areas for individual lots.
- Areas within loop roads or cul-de-sacs.
- Landscaped parking lot islands.
- Within [right-of-wayright of way](#)s along roads (often linear bioretention swales and cells).
- Common landscaped areas in apartment complexes or other multifamily housing designs.
- Planters on building roofs, patios, and as part of streetscapes.

[See Table 5.10 for a summary of which minimum requirements bioretention BMPs can be used to fully or partially satisfy.](#)

[Table 5.10. Bioretention Cells, Swales, and Planter Boxes \[Applicability\]\(#\)](#)

BMP	MR #5: On-site Stormwater Management		MR #6: Runoff Treatment				MR #7: Flow Control
	List	LID Performance Standard	Basic	Enhanced	Oil Control	Phosphorus	
Bioretention	X	X	X	X			X

5.4.6.4 Site Considerations

For bioretention [BMPsfacilities](#) utilizing infiltration into the native soils, [refer to see](#) the infiltration feasibility criteria provided in [Volume II](#), Section 5.3.2. See also the geometry requirements provided in [BMP T7.30 in Volume V, Chapter 5 of the Ecology Manual](#) to determine which types of bioretention fit best within the available space on-site.

5.4.6.5 Design Information

Pre-settling is required when the impervious area contributing to a single flow entrance is equal to or greater than 5,000 square feet. For impervious contributing areas between 5,000 and 10,000 square feet, the first 2 to 3 feet of the upstream bioretention cell (at the flow entrance) shall be designated as the pre-settling zone. This bottom area of the cell shall be constructed of cobbles, concrete open celled paving grids, roughened concrete pad, or similar material to collect sediment and streamline O&M activities. Alternatively, a catch basin with a minimum 2-foot sump may be used as the pre-settling zone. Wherever a pipe daylights into the bioretention cell, provide energy dissipation within the cell.

For impervious contributing areas greater than 10,000 square feet, pre-settling requirements will be determined on a case-by-case basis and design of pre-settling [facilities-BMPs must shall](#) be reviewed and approved by the director.

[Refer to See BMP T7.30 in Volume V, Chapter 5 of the Ecology Manual and the LID Technical Guidance Manual \(Hinman and Wulkan, 2012\)](#) for detailed design guidance and criteria ~~on the following components of design:~~. [County-specific design criteria include the following:](#)

- ~~Flow entrance and pre-settling (see also the above text in this section)~~
- ~~Bottom area and side slopes~~
- ~~Ponding area~~
- ~~Overflow~~
- ~~Bioretention soil media~~
- ~~Underdrains (optional)~~
- ~~Check dams and weirs (where required)~~
- ~~Underground Injection Control discharge (if deep infiltration is proposed per Section 5.3.2)~~
- ~~Hydraulic restriction layers (if proximity to roads, foundations, or other infrastructure requires the restriction of infiltration pathways)~~

- Plantings

- Invasive species and noxious weed control will be required as typical with all planted landscape areas.
- Trees are not allowed in the bottom of a linear bioretention cell. Trees may be allowed on unlined side slopes on a case-by-case basis.
- Trees shall be located a minimum horizontal offset of 5 feet or one half the mature root zone (whichever is greater) from underdrains. Trees shall have a minimum 3-foot vertical offset from underdrains.
- A recommended bioretention plant list is included in Appendix B of the Kitsap County Low Impact Guidance Manual (Kitsap Home Builders 2009).

1. Mulch layer

2. Excavation

Soil placement

See BMP T7.30 in Volume V, Chapter 5 of the Ecology Manual for guidance on Runoff Model Representation.

5.4.6.6 Minimum Construction Requirements

Controlling erosion and sediment are most difficult during clearing, grading, and construction; accordingly, minimizing site disturbance to the greatest extent practicable is the most effective sediment management tool. During construction:

- Bioretention BMPsfacilities shall not be used as sediment control BMPsfacilities and all drainage shall be directed away from bioretention BMPsfacilities after initial rough grading. Flow can be directed away from the facility-BMP with temporary diversion swales or other approved protection. If introduction of construction runoff cannot be avoided, refer to the other recommendations provided in this sectionsee below for guidelines.
- Construction of bioretention BMPsfacilities shall not begin until all contributing drainage areas are stabilized according to erosion and sediment control BMPs and to the satisfaction of the engineer.
- If the design includes curb and gutter, the curb cuts and inlets shall be blocked until Bioretention Soil Mix and mulch have been placed and planting completed (when possible), and dispersion pads are in place.

Every effort during design, construction sequencing and construction shall be made to prevent sediment from entering bioretention BMPsfacilities. However, bioretention areas are often distributed throughout the project area and can present unique challenges during construction. See the LID Technical Guidance Manual (Hinman and Wulkan, 2012) for guidelines if no other options exist and runoff during construction must be directed through the bioretention BMPsfacilities.

Note that the LID Technical Guidance Manual is for additional informational purposes only. The engineer ~~must~~shall follow the guidance within this manual if there are any discrepancies between this manual and the LID Technical Guidance Manual.

Erosion and sediment control practices ~~must~~shall be inspected and maintained on a regular basis.

5.4.6.7 Operations and Maintenance Requirements

Refer to the [Volume V, Appendix V-A of the Ecology Manual for specific maintenance activities and schedules for bioretention BMPs. See also the general infiltration BMP maintenance guidelines in that appendix. ~~Western Washington Low Impact Development Operation and Maintenance Guidance document \(Ecology 2013\) for specific maintenance activities and schedules for the various bioretention components.~~](#)

5.4.7 Perforated Stub-out Connections

5.4.7.1 BMP Description

A perforated stub-out connection ([BMP T5.10C in Volume V, Chapter 4 of the Ecology Manual](#)) is a length of perforated pipe within a gravel-filled trench that is placed between roof downspouts and a stub-out to the local drainage system ([see Perforated Stub-out Connection figure in Volume V, Chapter 4 in the Ecology Manual](#)).

5.4.7.2 Performance Mechanism

Perforated stub-out connections are intended to provide some infiltration during drier months. During the wet winter months, they may provide little or no flow control.

5.4.7.3 Applications and Limitations

Perforated stub-outs are not appropriate when seasonal water table is less than one foot below trench bottom.

In projects subject to MR #5: On-site Stormwater Management (see Volume I, [Section 4.2.5](#)), perforated stub-out connections may be used only when all other higher priority On-site Stormwater Management BMPs are not feasible, per the criteria for each of those BMPs.

Select the location of the connection to allow a maximum amount of runoff to infiltrate into the ground (ideally a dry, relatively well drained, location). To facilitate maintenance, do not locate the perforated pipe portion of the system under impervious or heavily compacted (e.g., driveways and parking areas) surfaces.

Have a licensed geologist, hydrogeologist, or engineering geologist evaluate potential runoff discharges towards landslide hazard areas. Do not place the perforated portion of the pipe on or above slopes greater than 20% or above erosion hazard areas without evaluation by a professional engineer with geotechnical expertise or qualified geologist and jurisdiction approval.

For sites with septic systems, the perforated portion of the pipe ~~must~~shall be down-gradient of the drainfield primary and reserve areas ([see Volume II, Section 5.3.1 and the Kitsap County Board of Health Ordinance 2008A-01, as now or hereafter amended](#)). This requirement can be

waived if site topography will clearly prohibit flows from intersecting the drainfield or where site conditions (soil permeability, distance between systems, etc.) indicate that this is unnecessary.

[Perforated stub-out connection BMPs may only be used to satisfy \(partially or fully\) MR #5: On-site Stormwater Management using the List approach \(see Table 5.11\). It may not be used for the LID Performance Standard nor to meet runoff treatment or flow control requirements.](#)

Table 5.11. Perforated Stub-out Connection [Applicability](#)

BMP	MR #5: On-site Stormwater Management		MR #6: Runoff Treatment				MR #7: Flow Control
	List	LID Performance Standard	Basic	Enhanced	Oil Control	Phosphorus	
Perforated Stub-out Connection	X						

5.4.7.4 Site Considerations

The stub-out connection shall be sited to allow a maximum amount of runoff to infiltrate into the ground (ideally a dry, relatively well drained, location). Site considerations for the applicability of perforated stub-out connections include:

- [Setbacks and Restrictions](#) - The perforated portion of the system shall meet the siting and infiltration rate requirements for infiltration [facilities-BMPs](#) presented in [Volume II](#), Section 5.3.2 and for infiltration trenches presented in [Volume II](#), Section 5.4.16.
- [Site Prohibitions](#) - The perforated pipe portion of the system shall not be located under hard or heavily compacted (e.g., driveways and parking areas) surfaces.

5.4.7.5 Design Information

Perforated stub-out connections consist of at least 10 feet of perforated pipe per 5,000 square feet of roof area laid in a level, 2-foot wide trench backfilled with washed drain rock. Extend the drain rock to a depth of at least 8 inches below the bottom of the pipe and cover the pipe. Lay the pipe level and cover the rock trench with filter fabric and 6 inches of fill ([see Perforated Stub-out Connection figure in Volume V, Chapter 4 in the Ecology Manual](#)).

Any flow reduction is variable and unpredictable. No computer modeling techniques are allowed that would predict any reduction in flow rates and volumes from the connected area.

[See BMP T5.10C in Volume V, Chapter 4 of the Ecology Manual for guidance on Runoff Model Representation.](#)

5.4.7.6 Minimum Construction Requirements

During construction, it is critical to prevent clogging and over-compaction of the subgrade. The minimum construction requirements for infiltration trenches in [Volume II](#), Section 5.4.16 apply.

5.4.7.7 Operations and Maintenance Requirements

General O&M guidelines and procedures for infiltration [BMPsfacilities](#) apply to perforated stub-out connections; see [Volume V, Appendix V-A of the Ecology Manual](#).

5.4.8 Permeable Pavement

5.4.8.1 BMP Description

Permeable pavement ([BMP T5.15 in Volume V, Chapter 5 of the Ecology Manual](#)) is a paving system that allows rainfall to infiltrate into an underlying aggregate storage reservoir, where stormwater is stored and infiltrated to the underlying subgrade or removed by an overflow drainage system.

A permeable pavement [facility-BMP](#) consists of a pervious wearing course (e.g., porous asphalt, pervious concrete, etc.) and an underlying storage reservoir. The storage reservoir is designed to support expected loads and store stormwater to allow time for the water to infiltrate into the underlying soil.

While not explicitly addressed in this section, infiltration may be allowed under impermeable pavements, [outside of public rights of way](#), in lieu of permeable pavement.

Pavement for vehicular and pedestrian travel occupies roughly twice the space of buildings. Stormwater from vehicular pavement can contain significant levels of solids, heavy metals, and hydrocarbon pollutants. Both pedestrian and vehicular pavements also contribute to increased peak flow durations and associated physical habitat degradation of streams and wetlands. Optimum management of stormwater quality and quantity from paved surfaces is, therefore, critical for improving fresh and marine water conditions in Puget Sound.

The general categories of permeable paving systems include:

- Porous Hot or Warm-Mix Asphalt Pavement - A flexible pavement similar to standard asphalt that uses a bituminous binder to adhere aggregate together. However, the fine material (sand and finer) is reduced or eliminated and, as a result, voids form between the aggregate in the pavement surface and allow water to infiltrate.
- Pervious Portland Cement Concrete - A rigid pavement similar to conventional concrete that uses a cementitious material to bind aggregate together. However, the fine aggregate (sand) component is reduced or eliminated in the gradation and, as a result, voids form between the aggregate in the pavement surface and allow water to infiltrate.
- Permeable Interlocking Concrete Pavements (PICP) and Aggregate Pavers - PICPs are solid, precast, manufactured modular units. The solid pavers are impervious high-strength Portland cement concrete manufactured with specialized production equipment. Pavements constructed with these units create joints that are filled with permeable aggregates and installed on an open-graded aggregate bedding course. Aggregate pavers (sometime called pervious pavers) are a different class of pavers from PICP. These include modular precast paving units made with similar sized aggregates bound together with Portland cement concrete with high-strength epoxy or other adhesives. Like PICP, the joints or openings in the units are filled with open-graded aggregate and

placed on an open-graded aggregate bedding course. Aggregate pavers are intended for pedestrian use only.

- **Grid Systems** - Include those made of concrete or plastic. Concrete units are precast in a manufacturing facility, packaged and shipped to the site for installation. Plastic grids typically are delivered to the site in rolls or sections. The openings in both grid types are filled with topsoil and grass or permeable aggregate. Plastic grid sections connect together and are pinned into a dense-graded base, or are eventually held in place by the grass root structure. Both systems can be installed on an open-graded aggregate base as well as a dense-graded aggregate base.

5.4.8.2 Performance Mechanism

Flow control occurs through temporary storage of stormwater runoff in the voids of the aggregate material and subsequent infiltration of stormwater into the underlying soils. Pollutant removal mechanisms include sedimentation, infiltration, filtration, adsorption, and biodegradation.

5.4.8.3 Application and Limitations

Permeable paving surfaces are an important integrated management practice within the LID approach and can be designed to accommodate pedestrian, bicycle and auto traffic while allowing [infiltration, runoff](#) treatment and [flow control storage](#) of stormwater.

Permeable pavements are appropriate in many applications where traditionally impermeable pavements have been used. Typical applications for permeable paving include parking lots, sidewalks, pedestrian and bike trails, driveways ~~(including shared driveways)~~, residential access roads, and emergency and facility maintenance roads.

[Limitations to permeable pavements include:](#)

- [No run-on from pervious surfaces is preferred. If runoff comes from minor or incidental pervious areas, those areas shall be fully stabilized to reduce or prevent erosion.](#)
- [Unless the pavement, base course, and subgrade have been designed to accept runoff from adjacent impervious surfaces, slope impervious runoff away from the permeable pavement to the maximum extent practicable. Sheet flow from up-gradient impervious areas is not recommended, but permissible if the permeable pavement area is greater than the impervious pavement area.](#)
- [Soils shall not be tracked onto the wear layer or the base course during construction.](#)

[As shown in Table 5.12, permeable pavement may be used to meet on-site stormwater management, runoff treatment and flow control requirements. Regarding runoff treatment, Ecology recognizes permeable pavement as a basic treatment BMP if it meets either of the following criteria:](#)

- [The native soils below the permeable pavement meet the criteria for Runoff Treatment per Volume V, Section 5.6 \(Site Suitability Criteria\) of the Ecology Manual; OR](#)

- [The permeable pavement design includes a 6-inch layer of sand that meets the size gradation \(by weight\) given in Sand Medium Specification table in Volume V, Chapter 6 of the Ecology Manual.](#)

[See the Permeable Pavement as a Runoff Treatment section in BMP T5.15 in Volume V, Chapter 5 of the Ecology Manual for additional information.](#)

~~Permeable pavement facilities can be designed to provide on-site stormwater management, flow control and/or water quality treatment. This BMP can be applied to meet or partially meet the requirements listed below.~~

Table 5.12. Permeable Pavement [Applicability](#) ^a

BMP	MR #5: On-site Stormwater Management		MR #6: Runoff Treatment				MR #7: Flow Control
	List	LID Performance Standard	Basic	Enhanced	Oil Control	Phosphorus	
Permeable Pavement	X	X	X ^a X ^b	X ^a			X

Notes:

- [b. Site suitability criteria apply \(see Volume V, Section 5.6 of the Ecology Manual\).](#)
 - [c. Ecology recognizes permeable pavement as a basic treatment BMP if the native soils below the permeable pavement meet the criteria for Runoff Treatment per Volume V, Section 5.6 in the Ecology Manual; or the permeable pavement design includes a 6" layer of sand that meets the size gradation \(by weight\) given in the \[Table V-6.1: Sand Medium Specification table in Volume V, Chapter 6 of the Ecology Manual.\]\(#\)](#)
- ~~a. _____~~

~~5.1.1.4 Underlying soil shall meet the treatment soil requirements outlined in [Volume V of the Ecology Manual, Section 5 Volume III of the Ecology Manual, Section 3.3.7](#) or a water quality treatment course shall be included (see the [-](#)).~~

5.4.8.4 [Site Considerations](#)

Unlike many [BMPsfacilities](#) that require dedicated space on a site, permeable pavement [BMPsfacilities](#) are part of the usable lot area and can replace conventional pavements, including:

- Sidewalks and pedestrian plazas
- Pedestrian and bike trails
- Driveways
- Most parking lots
- Low volume roads, alleys, and access drives

Site considerations for the applicability of permeable pavement [BMPsfacilities](#) include:

- [Setbacks and Restrictions](#) - Permeable pavement [BMPsfacilities](#) shall meet the siting and infiltration rate requirements for infiltration [BMPsfacilities](#) presented in [Volume II, Section 5.3.2.](#)

- Site Topography - The recommended maximum surface (wearing course) slope for permeable pavement [BMPsfacilities](#) is 6% to allow efficient storage of water within the subbase. For vehicular traction, the maximum surface slope varies by wearing course type ([refer to see](#) industry guidelines). Minimum wearing course slope shall be 1% unless provision is made for positive drainage in event of surface clogging.
- Slope - The recommended maximum subgrade slope for permeable pavement applications is 6%. Subgrades that are sloped require subsurface check dams to promote storage in the subgrade. At steeper subgrades slopes, design and construction become more complex and the construction cost increases.
- Land Use - Because permeable pavement can clog with sediment, permeable [pavement BMPspaving facilities](#) are not recommended where sediment and pollutant loading [isare](#) unavoidable, including the following conditions:
 - Excessive sediment contamination is likely on the pavement surface (e.g., construction areas, landscaping material yards).
 - It is infeasible to prevent stormwater run-on to the permeable pavement from unstabilized erodible areas without pre-settling.
 - Regular, heavy application of sand is anticipated for maintaining traction during winter, or the [facility-BMP](#) is in close proximity to areas that will be sanded. A minimum 7-foot clearance is required between a permeable pavement [BMPfacility](#) and the travel lane of sanded arterial roads.
 - Sites where the risk of concentrated pollutant spills are more likely (e.g., gas stations, truck stops, car washes, vehicle maintenance areas, industrial chemical storage sites, etc.).
- Accessibility - As for standard pavement design, Americans with Disabilities Act (ADA) accessibility issues shall be addressed when designing a permeable pavement [facilityBMP](#), particularly when using pavers.

5.4.8.5 Design Information

See [the-BMP T5.15 in Volume V, Chapter 5 of the Ecology Manual](#) for [permeable pavement design requirements](#) [and](#) Section 6.3 in the LID Technical Guidance Manual ([Hinman and Vulkan, 2012](#)) for additional guidance. [BMP T5.15 in Volume V, Chapter 5 of the Ecology Manual provides guidance on Runoff Model Representation for the following elements:](#)

[Contributing area](#)

[Flow entrance/pre-settling](#)

[Wearing course](#)

[Leveling course](#)

[Storage reservoir](#)

[Subgrade](#)

~~Subsurface check dams~~

~~Overflow~~

~~Geotextile~~

~~Water quality treatment course (if required)~~

~~Observation port~~

~~Underdrain (optional)~~

5.4.8.6 Minimum Construction Requirements

Proper construction methods and pre-planning are essential for the successful application of any permeable ~~pavement~~~~paving facility~~~~BMP~~. Over-compaction of the underlying soil or fine sediment contamination onto the existing subgrade and pavement section during construction will significantly degrade or effectively eliminate the infiltration capability of the ~~BMP~~~~facility~~.

Minimum requirements associated with construction of a permeable pavement ~~BMP~~~~facility~~ include the following:

- Conduct field infiltration and compaction testing of the water quality treatment course (if included) prior to placement of overlying courses.
- Prevent intermixing of the various base course materials with fines and sediment. Remove and replace all contaminated material.
- Complete final subgrade excavation during dry weather on the same day bottom aggregate course is placed, when practicable.
- Use traffic control measures to protect permeable pavement subgrade areas from heavy equipment operation or truck/vehicular traffic.
- Select excavation, grading, and compaction equipment to minimize the potential for over-compaction.
- Isolate the permeable pavement site from sedimentation during construction, either by use of effective erosion and sediment control measures upstream. Alternatively, delay the excavation of the lowest one foot of material above the final subgrade elevation for the entire pavement area until after all sediment-producing construction activities have been completed and upstream areas have been permanently stabilized. Once the site is stabilized, the lowest one foot of material may be removed. For more information on site stabilization, ~~refer to~~~~see~~ Volume I, Section 4.2.2.
- Conduct ~~infiltration test~~~~acceptance testing~~ in accordance with the [Infiltration Test for Permeable Pavement Surface](#)~~Acceptance Testing~~ subsection in [BMP T5.15 in Volume V, Chapter 5 of the Ecology Manual](#).

5.4.8.7 Operations and Maintenance

~~Refer to~~~~See~~ the [Maintenance section in BMP T5.15](#)~~BMP T5.15 in Volume V, Chapter 5 in~~ [Volume V, Chapter 5 and Volume V, Appendix V-A of the Ecology Manual](#) ~~Western Washington Low Impact Development Operation and Maintenance Guidance document (Ecology 2013)~~ for

further detail on specific maintenance activities and schedules for permeable pavement systems.

5.4.9 Tree Retention and Tree Planting

5.4.9.1 BMP Description

[Tree retention and tree planting \(BMP T5.16 in Volume V, Chapter 11 of the Ecology Manual\)](#) entails the ~~planting of~~ planting of ~~new trees can be planted~~ and/or protection of ~~existing trees can be protected~~ and retain ing ~~them~~ on a project site to achieve on-site stormwater management and/or flow control credits. See [Title 17 KCC](#) for discussion of tree retention.

5.4.9.2 Performance Mechanism

Trees provide flow control via interception, transpiration, and increased infiltration. Additional environmental benefits include improved air quality, carbon sequestration, reduced heat island effect, pollutant removal, and habitat preservation or formation.

5.4.9.3 Application and Limitations

Retained and newly planted trees [can be used to help meet the LID Performance Standard for on-site stormwater management and flow control requirements](#) ~~receive credits toward meeting On-site Stormwater Management and Flow Control requirements (Table 5.13)~~. The degree of flow control that can be provided depends on the tree type (i.e., evergreen or deciduous), maturity, canopy area, and whether or not the tree canopy overhangs hard surfaces. This BMP can be applied to meet or partially meet the requirements listed below.

Table 5.13. Tree Retention and Tree Planting Applicability

BMP	MR #5: On-site Stormwater Management		MR #6: Runoff Treatment				MR #7: Flow Control
	List	LID Performance Standard	Basic	Enhanced	Oil Control	Phosphorus	
Tree Retention and Planting		X					X

5.4.9.4 Site Considerations

Setbacks of proposed infrastructure from existing trees are critical considerations. Tree protection requirements limit grading and other disturbances in proximity to the tree.

Existing tree species and location must-shall be clearly shown on submittal drawings.

Trees must-shall be viable for long-term retention (i.e., in good health and compatible with proposed construction).

See [BMP T5.16 in Volume V, Chapter 11 of the Ecology Manual](#) for additional site considerations.

5.4.9.5 Design Information

[A recommended street tree list is included in Appendix B of the Kitsap County Low Impact Guidance Manual \(Kitsap Home Builders 2009\).](#)

Refer-See BMP T5.16 in Volume V, Chapter 11 of the Ecology Manual for design guidance, requirements, ~~and~~ hydrologic modeling credits, and guidance for Runoff Model Representation for retained trees and newly planted trees.

5.4.10 Vegetated Roofs

5.4.10.1 BMP Description

Vegetated roofs ([BMP T5.17 in Volume V, Chapter 11 of the Ecology Manual](#)) are areas of living vegetation installed on top of buildings, or other above-grade impervious surfaces. Vegetated roofs are also known as ecoroofs, green roofs, and roof gardens.

A vegetated roof consists of a system in which several materials are layered to achieve the desired vegetative cover and stormwater management function. Design components vary depending on the vegetated roof type and site constraints, but may include a waterproofing material, a root barrier, a drainage layer, a separation fabric, a growth media (soil), and vegetation. Vegetated roof systems are categorized by the depth and the types of courses used in their construction.

- Intensive Roofs - Intensive roofs are deeper installations, comprised of at least 6 inches of growth media and planted with ground covers, grasses, shrubs and sometimes trees.

- **Extensive roofs** - Extensive roofs are shallower installations, comprised of less than 6 inches of growth media and planted with a palette of drought-tolerant, low maintenance ground covers. Extensive vegetated roofs have the lowest weight and are typically the most suitable for placement on existing structures. Extensive systems are further divided into two types:
 - Single-course systems consist of a single growth media designed to be freely draining and support plant growth.
 - Multi-course systems include both a growth media layer and a separate, underlying drainage layer.

5.4.10.2 Performance Mechanism

Vegetated roof systems can provide flow control via attenuation, soil storage, and losses to interception, evaporation, and transpiration.

5.4.10.3 Application and Limitations

Vegetated roof systems can be designed to ~~provide-meet the LID Performance Standard but cannot be used in the List approach to meet on-site stormwater management requirements.~~ They can also be used to meet on-site stormwater management and flow control requirements (Table 5.14). The degree of flow control provided by vegetated roofs can vary greatly depending on the growth media (soil) depth, growth media composition, drainage layer characteristics, vegetation type, roof slope, and other design considerations. This BMP can be applied to meet ~~or partially meet the requirements listed below~~ the requirements listed below.

Table 5.14. Vegetated Roofs Applicability

BMP	MR #5: On-site Stormwater Management		MR #6: Runoff Treatment				MR #7: Flow Control
	List	LID Performance Standard	Basic	Enhanced	Oil Control	Phosphorus	
Vegetated Roofs		X					X

5.4.10.4 Site Considerations

Vegetated roof systems for stormwater management are accepted for roof slopes between one (1) and 22 degrees (0.2:12 and 5:12); but require additional analysis at slopes exceeding ten (10) degrees (2:12).

A primary consideration for the feasibility of vegetated roofs is the structural capability of the roof and building structure. Related factors, including design load, slipping and shear issues, and wind load, are outside the scope of this manual.

5.4.10.5 Design Information

See the LID Technical Guidance Manual (Hinman and Wulkan, 2012) for a more detailed description of the components of and design criteria for vegetated roofs. It also includes references to other sources of information and design guidance.

Note that the LID Technical Guidance Manual is for additional informational purposes only. Follow the guidance within this manual if there are any discrepancies between this manual and the LID Technical Guidance Manual. The following sections provide a description, recommendations, and requirements for the common components of vegetated roof systems, including:

See BMP T5.17 in Volume V, Chapter 11 of the Ecology Manual for guidance on Runoff Model Representation.

Roof slope

Vegetation

Growth media

Drainage layer

Drain system and overflow

While vegetated roofs will include additional system components (e.g., waterproof membrane, root barrier, separation fabric for multi-course systems), the design and construction requirements for these components are outside of the scope of this manual.

Refer to the LID Technical Guidance Manual for a more detailed description of the components and design criteria for vegetated roofs, as well as additional references and design guidance.

Roof Slope

Vegetated roofs can be applied to a range of rooftop slopes; however, steeper slopes may result in reduced flow control performance and may warrant a more complicated design (e.g., lateral support measures). Roofs with slopes between one and five degrees (0.2:12 and 1:12) are the easiest to install, are the least complex, and generally provide the greatest stormwater storage capacity per inch of growth media.

For on-site or flow control compliance, the roof slope shall be between one (1) and 22 degrees (0.2:12 and 5:12). Roofs with slopes greater than 10 degrees (2:12) require an analysis of engineered slope stability.

Vegetation

Vegetation used on extensive vegetated roofs shall be drought tolerant, self-sustaining, low maintenance, and perennial or self-sowing. Appropriate plants should also be able to withstand heat, cold, periodic inundation and high winds. Vegetation with these attributes typically includes succulents, grasses, herbs, and wildflowers that are adapted to harsh conditions. Refer to the LID Technical Guidance Manual for additional vegetation guidance for vegetated roofs.

Minimum requirements associated with vegetation design include the following:

~~The design plans shall specify that vegetation coverage of selected plants will achieve 80% coverage within two years.~~

~~For non-single family residential projects, plant spacing and plant size shall be designed to achieve specified coverage by a licensed landscape architect.~~

~~Vegetation shall be suitable for rooftop conditions (e.g., hot, cold, dry, and windy).~~

~~Plants shall not require fertilizer, pesticides or herbicides after 2-year establishment period.~~

Growth Media

~~Vegetated roof systems use a light weight growth media with adequate fertility and drainage capacity to support plants and allow filtration and storage of water. Growth media composition (fines content and water holding capacity) is key to flow control performance. Refer to the LID Technical Guidance Manual for additional guidance on growth media design.~~

~~Minimum requirements associated with the growth media design include the following:~~

~~The growth media shall be a minimum of 4 inches deep.~~

~~For non-single family residential projects, growth media depth and characteristics shall support growth for selected plant species and shall be approved by a licensed landscape architect.~~

~~Vegetated roofs shall not be subject to any use that will significantly compact the growth media.~~

~~Unless designed for foot traffic, vegetated roof areas that are accessible to the public shall be protected (e.g., signs, railing, fencing) from foot traffic and other loads.~~

~~Biodegradable erosion control blanket or other measures to control erosion of growth media shall be maintained until 90% vegetation coverage is achieved.~~

Drainage Layer

~~Intensive and extensive multi-course vegetated roof systems shall include a drainage layer below the growth media. The drainage layer is a multipurpose layer designed to provide void spaces to hold a portion of the water that passes through the growth media and to channel the water to the roof drain system. The drainage layer can consist of a layer of aggregate or a manufactured mat or board that provides an open free draining area. Many manufactured products include egg carton shaped depressions that retain a portion of the water for eventual evapotranspiration.~~

Drain System and Overflow

~~Vegetated roof systems shall be equipped with a roof drainage system capable of collecting subsurface and surface drainage and conveying it safely to a downstream BMP or an approved point of discharge. To facilitate subsurface drainage, interceptor drains (i.e., underdrains) are often installed at a regular spacing to prevent excessive moisture build up in the media and convey water to the roof drain. Roof outlets shall be protected from encroaching plant growth and loose gravel, and shall be constructed and located so that they are permanently accessible.~~

5.4.10.6 **Minimum Construction Requirements**

The growth media shall be protected from over-compaction during construction. See [Section 6.5 of the LID Technical Guidance Manual \(Hinman and Wulkan, 2012\)](#) for additional requirements.

5.4.10.7 **Operations and Maintenance**

See [BMP T5.17 in Volume V, Chapter 11 of the Ecology Manual for general O&M guidelines and procedures for vegetated roofs.](#)

~~Refer to the [Western Washington Low Impact Development Operation and Maintenance Guidance](#) document (Ecology 2013) for details on specific maintenance activities and schedules for vegetated roofs.~~

5.4.11 **Reverse Slope Sidewalks**

5.4.11.1 **BMP Description**

Reverse slope sidewalks ([BMP T5.18 in Volume V, Chapter 11 of the Ecology Manual](#)) are sloped to drain away from the road and onto adjacent vegetated areas.

5.4.11.2 **Performance Mechanism**

Sheet flow from a sidewalk is directed towards a vegetated strip and away from directly connected impervious surfaces.

5.4.11.3 **Application and Limitations**

This BMP is applicable for new or replaced sidewalks with adequate vegetated flow path length down-gradient from the sidewalk. [It can be used to meet the LID Performance Standard and flow control requirements \(Table 5.15\).](#)

Sites where it is not practical to direct sheet flow runoff to the back of sidewalk, like directly onto private property or into a cut slope, are not recommended for reverse slope sidewalks. Evaluate the downstream flow path behind the sidewalk to determine applicability for each specific location.

Table 5.15. Reverse Slope Sidewalks [Applicability](#)

BMP	MR #5: On-site Stormwater Management		MR #6: Runoff Treatment				MR #7: Flow Control
	List	LID Performance Standard	Basic	Enhanced	Oil Control	Phosphorus	
Reverse slope sidewalks		X					X

5.4.11.4 **Design Information**

The following design criteria apply to reverse slope sidewalks:

- Greater than 10 feet of vegetated surface downslope that is not directly connected into the storm drainage system must-shall be available to disperse sheet flow runoff from the sidewalk.
- Vegetated area receiving flow from a sidewalk must-shall be native soil or meet the guidelines in [BMP T5.13 in Volume V, Chapter 11 of the Ecology Manual](#).

[See the Runoff Model Representation modeling requirements in BMP T5.18 in Volume V, Chapter 11 of the Ecology Manual.](#)

5.4.11.5 Minimum Construction Requirements

Construct similar to a traditional sidewalk, with the sidewalk surface sloping away from the road, directing stormwater runoff evenly onto down-gradient vegetated flow paths.

5.4.11.6 Operations and Maintenance

Maintenance practices of reverse slope sidewalks shall follow those of traditional sidewalks. Additionally, maintenance of the downslope vegetated surface shall be conducted as needed to maintain sheet flow conditions.

5.4.12 Minimal Excavation Foundations

5.4.12.1 BMP Description

Minimal excavation foundations ([BMP T5.19 in Volume V, Chapter 11 of the Ecology Manual](#)) are defined as those techniques that do not disturb, or minimally disturb the native soil profile within the footprint of the structure. Pin foundations are an example of minimal excavation foundations.

5.4.12.2 Performance Mechanisms

By minimizing the disturbance and compaction of the soil, the hydrologic properties of the native soil are preserved.

5.4.12.3 Applications and Limitations

Minimal excavation foundations can be used to partially or completely achieve the LID Performance Standard associated with MR #5: On-site Stormwater Management, and the flow control standard associated with MR #7: Flow Control ([Table 5.16](#)).

Table 5.16. Minimal Excavation Foundation [Applicability](#)

BMP	MR #5: On-site Stormwater Management		MR #6: Runoff Treatment				MR #7: Flow Control
	List	LID Performance Standard	Basic	Enhanced	Oil Control	Phosphorus	
Minimal Excavation Foundation		X					X

5.4.12.4 Minimal Excavation Site Considerations

Foundations can be used in conjunction with downspout dispersion ([Volume II](#), Section 5.4.4) to receive further modeling credit.

5.4.12.5 Design Information

[See the Runoff Model Representation modeling requirements in BMP T5.19 in Volume V, Chapter 11 of the Ecology Manual.](#)

[5.1.1.5 Volume V of the Ecology Manual provides guidance on runoff modeling credits that can be applied to the roof area if minimal excavation foundations are used.](#)

5.4.12.6 Minimum Construction Requirements

[To minimize soil compaction, heavy equipment, including pile driving equipment that would degrade the natural soil profile’s ability to retain, drain and/or filter stormwater, cannot be used within or immediately surrounding the building. Tracked equipment weighing 650 pounds per square foot or less is acceptable. To minimize soil compaction, heavy equipment cannot be used within or immediately surrounding the building. Terracing of the foundation area may be accomplished by tracked, blading equipment not exceeding 650 pounds-per-square-foot.](#)

5.4.12.7 Operations and Maintenance Requirements

There are no operations and maintenance activities specific to minimal excavation foundations. If used in conjunction with other BMPs, like downspout dispersion or post-construction amended soils, [refer to see](#) the maintenance requirements associated with those.

5.4.13 Rainwater Harvesting

5.4.13.1 BMP Description

Rainwater harvesting ([BMP T5.20 in Volume V, Chapter 11 of the Ecology Manual](#)) is the capture and storage of rainwater for [beneficial subsequent](#) use. [Roof runoff. Runoff from roofs](#) may be routed to cisterns for storage and [beneficial](#) non-potable uses, such as irrigation, [toilet flushing, and cold water laundrymechanical equipment, industrial process uses, toilet flushing, and the cold water supply for laundry.](#) The potable use of collected rainwater may be used for

single-family residences with proper design and approval from Kitsap County Public Health District.

5.4.13.2 Performance Mechanism

Rainwater harvesting can be used to achieve reductions in peak flows, flow durations and runoff volumes. The flow control performance of rainwater harvesting is a function of contributing area, storage volume and rainwater use rate.

5.4.13.3 Application and Limitations

Rainwater harvesting systems can be designed to provide on-site stormwater management and flow ~~control, and~~ control and can be an effective volume reduction practice for projects where infiltration is not permitted or desired (Table 5.17). Rainwater harvesting has higher stormwater management benefits when designed for uses that occur regularly through the wet season (e.g., toilet flushing and ~~cold water~~ cold-water laundry). The use of harvested rainwater for irrigation during the dry months provides less benefit.

~~This BMP can be applied to meet the requirements listed below.~~ Rainwater harvesting functions can be used alone or can be combined with detention pipes, vaults, and cisterns to improve on-site stormwater management and flow control performance.

Table 5.17. Rainwater Harvesting Applicability

BMP	MR #5: On-site Stormwater Management		MR #6: Runoff Treatment				MR #7: Flow Control
	List	LID Performance Standard	Basic	Enhanced	Oil Control	Phosphorus	
Rainwater Harvesting		X					X

5.4.13.4 Site Considerations

Rainwater harvesting can be used for new or retrofit projects. Depending upon site constraints, cisterns may be installed at grade, underground, under a deck, or in a basement or crawl space (applicants ~~must~~ shall be mindful of required setbacks and “no-build” buffers). Cisterns may be used individually or connected to each other in a series for increased storage capacity. When the captured water is solely for outdoor use, the use of rainwater harvesting should be limited to 4 homes/acre and lower densities.

5.4.13.5 Design Information

In order to use the guidance for Runoff Model Representation in BMP T5.20 in Volume V, Chapter 11 of the Ecology Manual, the design shall show 100% reuse of the annual average runoff volume. The designer shall use an approved continuous runoff model to calculate the annual average for drainage area.

System designs involving interior uses shall have a monthly water balance that demonstrates adequate capacity for each month and reuse of all stored water annually.

Restrict the use of this BMP to 4 homes/acre housing and lower densities when the captured water is solely for outdoor use.

Refer to See Section 6.7 of the LID Technical Guidance Manual (Hinman and Wulkan, 2012) and BMP T5.20 in Volume V, Chapter 11 of the Ecology Manual for detailed design guidance and criteria on the following components of rainwater harvesting systems:

Catchment or roof area

Gutters and downspouts

First flush diverters

Roof washers

Storage tank or cistern

Pumps and pressure tanks

Back flow prevention

Water treatment

Volume V of the Ecology Manual, BMP T5.20 also includes guidance for runoff modeling credits.

5.4.13.6 Minimum Construction Requirements

Rainwater harvesting systems shall be constructed according to the manufacturer's recommendations, the Kitsap County's Technical Building Codes ([Chapter 14.04 KCC](#)), and all applicable laws.

5.4.13.7 Operations and Maintenance

Refer to [Section 6.7 of the LID Technical Guidance Manual \(Hinman and Wulkan 2012 Ecology 2013\)](#) for details on maintenance activities and schedules for the various rainwater harvesting components.

5.4.14 Pre-settling Basins

5.4.14.1 BMP Description

A pre-settling basin ([BMP T6.10 in Volume V, Chapter 9 of the Ecology Manual](#)) provides ~~pre-treat~~pretreatment of runoff prior to discharge into downstream BMPs, such as bioretention ~~facilities~~, detention ponds, detention pipes, detention vaults, sand filters, wetponds, and stormwater treatment wetlands. The purpose of the pre-settling basins is to provide pretreatment of runoff in order to remove suspended solids, which can impact the downstream BMP performance, and to help consolidate the removed suspended solids in relatively easy-to-maintain areas.

While tThis section presents only one BMP for pre-settling basins ([BMP T6.10 in Volume V, Chapter 9 of the Ecology Manual](#)), other patented-manufactured devices and BMPs~~devices~~ have received a General Use Level Designation for pretreatment through [Ecology's TAPE program](#).

~~5.1.1.6 Many BMPs in this chapter, including bioretention, sand filters, and wetponds, have specific pre-treatment and/or pre-settling requirements. Use those BMP-specific requirements for pre-treatment and pre-settling where provided.~~

5.4.14.2 Performance Mechanism

Pre-settling basins slow down the velocity of incoming stormwater, which allows particulates and particulate-bound pollutants to settle.

5.4.14.3 Applications and Limitations

Pre-settling basins on their own do not satisfy any stormwater minimum requirements. They are rather used upstream of other On-site Stormwater Management, Flow Control, and [Water Quality Runoff Treatment BMPs](#) to reduce sedimentation in those BMPs and facilitate drainage system maintenance by focusing sedimentation in preferred locations.

~~Many BMPs in this chapter, including bioretention, sand filters, and wetponds, have specific pretreatment and/or pre-settling requirements. Use those BMP-specific requirements for pretreatment and pre-settling where provided.~~

5.4.14.4 Site Considerations

~~Site constraints are any manmade restrictions such as property lines, easements, structures, etc. that impose constraints on development. Constraints may also be imposed from natural features such as requirements of Title 19 KCC. These should also be reviewed for specific application to the proposed development.~~

Pre-settling ~~basins~~[facilities](#) shall be a minimum of 20 feet from any structure, property line, and any vegetative buffer required by [Title 17 KCC](#).

~~Pre-settling basins~~[All facilities](#) shall be 100 feet from any septic tank/drainfield ~~(except wet vaults shall be a minimum of 20 feet)~~. [See Volume II, Section 5.3.1 and the Kitsap County Board of Health Ordinance 2008A-01, as now or hereafter amended, for additional information regarding regulations for septic tank/drainfields.](#)

~~Pre-settling basins~~[All facilities](#) shall be a minimum of 50 feet from any ~~slopesteepest~~ [slope](#) ~~(greater than 15%)~~ ~~slope and~~ a geotechnical report ~~must~~[shall](#) address the potential impact of a wetpond on a steep slope. See reporting requirements in Volume II, Chapter 1 ~~of this manual~~.

Embankments that impound water must comply with the Washington State Dam Safety Regulations ([Chapter 173-175 WAC](#)). If the impoundment has a storage capacity (including both water and sediment storage volumes) greater than 10 acre-feet (435,600 cubic feet or 3.26 million gallons) above natural ground level, [or has an embankment height of > 6 feet at the downstream toe](#), then dam safety design and review are required by Ecology. See [BMP D.1 in Volume V, Chapter 12 of the Ecology Manual](#) for more detail.

5.4.14.5 Design Information

Refer to [BMP T6.10 in Volume V, Chapter 9 of the Ecology Manual](#) for ~~detailed~~ design guidance and criteria ~~on the following components of pre-settling basins:~~

~~Wetpool~~

~~Liner (if required)~~

Geometry considerations:

Length-to-width ratio

Minimum depth

Inlets and outlets

5.4.14.6 Minimum Construction Requirements

Use a low permeability liner or treatment liner if the basin will intercept the seasonal high ground water table. Provide 1-foot minimum sediment storage depth.

5.4.14.7 Operations and Maintenance

Maintenance of pre-settling basins shall be similar to that of wetvaults and wetponds. See [Volume V, Appendix V-A of the Ecology Manual](#).

5.4.15 Infiltration Basins

5.4.15.1 BMP Description

Infiltration basins ([BMP T7.10 in Volume 5, Chapter 5 of the Ecology Manual](#)) are earthen impoundments used for the collection, temporary storage and infiltration of influent stormwater runoff.

5.4.15.2 Performance Mechanism

Pollutant removal and flow control occur through infiltration of stormwater into the underlying soils. Secondary pollutant removal mechanisms include filtration, adsorption, and biological uptake.

5.4.15.3 Application and Limitations

~~An infiltration basin~~[Infiltration basins](#) can be designed to ~~provide treatment and/or flow control~~[meet on-site stormwater management, runoff treatment \(basic and enhanced\), and flow control requirements \(see Table 5.18\)](#). ~~This BMP can be applied to meet the requirements listed below.~~

Table 5.18. Infiltration Basins [Applicability](#)^a

BMP	MR #5: On-site Stormwater Management		MR #6: Runoff Treatment ^a				MR #7: Flow Control
	List	LID Performance Standard	Basic	Enhanced	Oil Control	Phosphorus	
Infiltration Basin		X	X ^a	X ^a			X

Notes:

~~4.4.2.1 a~~ [SiteSoil suitability criteria for treatment and applicable drawdown requirements apply \(see Volume V, Section 5.6 of the Ecology Manual also apply\).](#)

5.4.15.4 Site Considerations

~~See~~ Refer to [Volume II, Section 5.3.2](#) and [Volume V, Section 5.6 of the Ecology Manual](#) for site considerations ~~suitability criteria~~ related to infiltration basins.

5.4.15.5 Design Information

~~If this BMP is proposed to be used for Runoff Treatment, the design shall show that the criteria for Runoff Treatment in Volume V, Section 5.6 (Site Suitability Criteria) in the Ecology Manual are met. Refer to~~ See [BMP T7.10 in Volume V, Chapter 5 of the Ecology Manual](#) for detailed design guidance and criteria on infiltration basins. ~~Design information is provided for the following components of design:~~

- ~~Access~~
- ~~Slope~~
 - ~~Sizing~~
 - ~~Freeboard~~
 - ~~Treatment (if soil suitability criteria for treatment per Volume III of the Ecology Manual, Section 3.3.7 are met)~~
 - ~~Lining (if required)~~
 - ~~Vegetation~~

5.4.15.6 Minimum Construction Requirements

Conduct initial basin excavation to within 1 foot of the final elevation of the basin floor. Excavate infiltration trenches and basins to final grade only after all disturbed areas in the upgradient project drainage area have been permanently stabilized. The final phase of excavation shall remove all accumulation of silt in the infiltration ~~facility~~ [BMP](#) before putting it in service. After construction completion, prevent sediment from entering the infiltration [BMP](#) ~~facility~~ by first conveying the runoff water through an appropriate pretreatment system such as a pre-settling basin, wetpond, or sand filter.

Generally, do not use infiltration [BMP](#) ~~facilities~~ as temporary sediment traps during construction. If an infiltration ~~facility~~ [BMP](#) has been pre-approved by DCD for use as a sediment trap, do not excavate to final grade until after the stabilizing the upgradient drainage area. Remove any accumulation of silt in the basin before putting it in service. Approval for use of an infiltration [BMP](#) ~~facility~~ as a temporary sediment trap may be considered by DCD on a case-by-~~cb~~ase basis.

Relatively light-tracked equipment is recommended to avoid compaction of the basin floor. Consider the use of draglines and trackhoes for constructing infiltration basins. Flag or mark the infiltration area to keep heavy equipment away.

5.4.15.7 Operations and Maintenance

Refer to See [BMP T7.10 in Volume V, Chapter 5 of the Ecology Manual](#) for maintenance practices for infiltration basins.

5.4.16 Infiltration Trenches

5.4.16.1 BMP Description

Infiltration trenches ([BMP T7.20 in Volume V, Chapter 5 of the Ecology Manual](#)) are trenches backfilled with a coarse aggregate. Stormwater runoff can enter the trench as overland surface flow through a grate or exposed aggregate surface, or as concentrated flow delivered to the aggregate-filled trench using a perforated or slotted distribution pipe.

[Infiltration trenches that include perforated pipe are UICs and shall follow the applicable requirements in Volume I, Chapter 4 in the Ecology Manual.](#)

[If this BMP is proposed to be used for Runoff Treatment, the design shall show that the criteria for Runoff Treatment in Volume V, Section 5.6 Site Suitability Criteria \(SSC\) in the Ecology Manual are met.](#)

5.4.16.2 Performance Mechanism

Flow control occurs through temporary storage of stormwater runoff in the spatial voids of the aggregate material and subsequent infiltration of stormwater into the underlying soils. Pollutant removal mechanisms include infiltration, filtration, adsorption, and biodegradation.

5.4.16.3 Application and Limitations

An infiltration trench can be designed to provide on-site stormwater management, flow control and/or runoff treatment (see [Table 5.19](#)). ~~This BMP can be applied to meet the requirements listed below.~~

Table 5.19. Infiltration Trenches [Applicability](#)^a

BMP	MR #5: On-site Stormwater Management		MR #6: Runoff Treatment ^a				MR #7: Flow Control
	List	LID Performance Standard	Basic	Enhanced	Oil Control	Phosphorus	
Infiltration Trenches		X	X ^a	X ^a			X

Notes:

- a. ~~Soil Site suitability criteria apply (see Volume V, Section 5.6 of the Ecology Manual). suitability criteria for treatment and applicable drawdown requirements (Volume III of the Ecology Manual, Section 3.3.7) also apply.~~

5.4.16.4 Site Considerations

Site considerations for the applicability of infiltration ~~BMPsfacilities~~ including trenches are provided in [Volume II](#), Section 5.3.2.

5.4.16.5 Design Information

Refer to [BMP T7.20 in Volume V, Chapter 5 of the Ecology Manual](#) for detailed design guidance and criteria on infiltration ~~basins/trenches~~. ~~Design information is provided for the following components of design:~~

~~Trench dimensions and layout~~

~~Aggregate material~~

~~Geotextile~~

~~Subgrade~~

~~Flow entrance and pre-settling~~

~~Perforated pipe~~

~~Observation port~~

~~Overflow~~

5.4.16.6 Minimum Construction Requirements

During construction, it is critical to prevent clogging and over-compaction of the subgrade. Minimum requirements associated with infiltration trench construction include the following:

- Aggregate Placement and Compaction – ~~Place stone aggregate in lifts and compact using plate compactors. In general, a maximum loose lift thickness of 12 inches is recommended. The compaction process ensures geotextile conformity to the excavation sides, thereby reducing potential piping and geotextile clogging, and settlement problems. Place the stone aggregate in lifts and compact using plate compactors. A maximum loose lift thickness of 12 inches is allowed. The compaction process aids in adhering the geotextile to the excavation sides, thereby, reducing soil piping, geotextile clogging, and settlement problems.~~
- Potential Contamination – Prevent natural or fill soils from intermixing with the aggregate. Remove all contaminated aggregate and replace with uncontaminated aggregate.
- Overlap – Following the stone aggregate placement, fold the geotextile over the stone aggregate to form a 12-inch minimum longitudinal overlap. When geotextile overlaps are required between rolls, overlap the upstream roll a minimum of 2 feet over the downstream roll in order to provide a shingled effect.

5.4.16.7 Operations and Maintenance

~~Monitor sediment buildup in the top foot of stone aggregate or the surface inlet on the same schedule as the observation well.~~

~~General maintenance requirements for infiltration facilities apply to infiltration trenches; refer to Volume V of the Ecology Manual.~~

5.4.17 Drywells

5.4.17.1 BMP Description

Drywells (BMP T7.50 in Volume V, Chapter 5 of the Ecology Manual) are subsurface concrete structures, typically precast, that convey stormwater runoff into the soil matrix. They can be used as standalone structures, or part of a larger drainage system (i.e., the overflow for a biofiltration/bioretention swale).

Drywells are similar to infiltration trenches but are typically deeper and require less surface area. If the drywell meets the definition of an Underground Injection Control (UIC) per the WAC 173-218-030, then UIC regulations must be followed (WAC 173-218). Drywells are UICs and shall follow the applicable requirements in Volume I, Chapter 4 in the Ecology Manual.

5.4.17.2 Performance Mechanism

Flow control occurs through temporary storage of stormwater runoff in the spatial voids of the aggregate material, and subsequent infiltration of stormwater into the underlying soils.

5.4.17.3 Application and Limitations

A drywell can be designed to provide partially or fully satisfy on-site stormwater management and/or flow control requirements (see Table 5.20). ~~This BMP can be applied to meet the requirements listed below.~~

Table 5.20. Drywells Applicability

BMP	MR #5: On-site Stormwater Management		MR #6: Runoff Treatment ^a				MR #7: Flow Control
	List	LID Performance Standard	Basic	Enhanced	Oil Control	Phosphorus	
Drywells		X					X

Notes:

a. Site suitability criteria apply (see Volume V, Section 5.6 of the Ecology Manual).

5.4.17.4 Site Considerations

Site considerations for the applicability of infiltration BMPs/facilities including drywell/trenches are provided in Volume II, Section 5.3.2. In addition:

- Drywell bottoms shall be a minimum of 5 feet above seasonal high groundwater level or impermeable soil layers (See Volume V, Section 5.6 (Site Suitability Criteria) in the Ecology Manual).
- Drywells are typically a minimum of 48 inches in diameter and approximately 5 to 10 feet deep, or more.

- Filter fabric (geotextile) may need to be placed on top of the drain rock and on trench or drywell sides prior to backfilling to prevent migration of fines into the drain rock, depending on local soil conditions and local jurisdiction requirements.
- Drywells shall be no closer than 30 feet center to center or twice the depth, whichever is greater.
- Drywells shall not be built on slopes greater than 25% (4:1).
- Drywells ~~may~~ shall not be placed on or above a landslide hazard area or slopes greater than 15% without evaluation by a engineer licensed professional engineer in the state of Washington state with geotechnical expertise or qualified licensed geologist and jurisdiction approval.
- Drywells shall be sited at least 100 feet up-slope and 20 feet down-slope from building foundations.

5.4.17.5 Design Information

~~The following section provides descriptions and requirements for the components of drywells. Design criteria are provided in this section for the following elements:~~

- ~~a. Drywell dimensions and layout~~
- ~~b. Aggregate material~~
- ~~c. Geotextile~~
- ~~d. Subgrade~~
- ~~e. Flow entrance and pre-settling~~
- ~~f. Perforated pipe~~
- ~~g. Observation port~~
- ~~h. Overflow~~

Minimum requirements associated with drywell dimensions and layout include the following:

- The minimum depth of a drywell (aggregate and cover) varies between the two types of Drywells. Type 1 Infiltration Drywells shall be a minimum of 54 feet with a 9-foot minimum depth as required to penetrate the pervious strata. Type 2 Infiltration Drywells shall be sized based on drainage analysis, but shall be a minimum of 13-inches deep (see BMP T7.50 in Volume V, Chapter 5 of the Ecology Manual).
- Drywells are typically a minimum of 48 inches in diameter and approximately 5 to 10 feet deep, or more.
- Spacing between drywells shall be a minimum of ~~30~~40 feet or twice the depth, whichever is greater.
- The drywell can be placed under a pervious or impervious surface cover to conserve space.

Drywells shall be filled with uniformly graded, washed gravel with a nominal size from 0.75- to 1.5-inch diameter. The minimum void volume shall be 30%.

Non-woven geotextile fabric shall be placed around the walls, bottom and top of the drywell aggregate. A 6-inch minimum layer of sand may be used as a filter media instead of geotextile at the bottom of the well, but geotextile is still required on the sides and top of the aggregate material.

The minimum measured subgrade infiltration rate for drywells is 5 inches per hour. If runoff from any PGHS is directed to the drywell, underlying soil shall meet the [soil-site](#) suitability requirements for treatment outlined [in Volume V, Section 5.6 in the Ecology Manual](#).

During construction the subgrade soil surface can become smeared and sealed by excavation equipment. The design shall require scarification or raking of the side walls and bottom of the [facilityBMP](#) excavation to a minimum depth of 4 inches after excavation to restore infiltration rate.

Flows shall be delivered to the drywell aggregate using a pipe with a 4-inch minimum diameter. Stormwater inflows shall be routed through a catch basin or yard drain with downturned elbow (trap).

Drywells that are designed to meet flow control requirements and receive runoff from contributing areas of 5,000 square feet or more shall be equipped with an observation port to measure the drawdown time following a storm and to monitor sedimentation to determine maintenance needs. Observation wells shall consist of a 4-inch minimum diameter perforated or slotted pipe that extends to the bottom of the drywell (i.e., to the subgrade) and is equipped with a secure well cap.

Drywells shall have an overflow designed to convey any flow exceeding the capacity of the [facilityBMP](#). If overflow is connected to the public drainage system, a catch basin shall be installed prior to the connection to the public drainage system to prevent root intrusion into public drainage main lines.

To prevent damage to overlying pavement, drywells located beneath pavement shall be constructed with a trench pipe overflow connected to a small yard drain or catch basin with a grate cover. Design shall be such that, if the drywell infiltration capacity is exceeded, the trench pipe overflow would occur out of the catch basin to an approved point of discharge. The vertical elevation difference between the pavement surface and the trench pipe overflow invert shall be 1-foot minimum.

5.4.17.6 Minimum Construction Requirements

During construction, it is critical to prevent clogging and over-compaction of the subgrade. Minimum requirements associated with drywell construction include the following:

- [Aggregate Placement and Compaction](#) – Place the stone aggregate in lifts and compact using plate compactors. A maximum loose lift thickness of 12 inches is allowed. The compaction process aids in adhering the geotextile to the excavation sides, thereby, reducing soil piping, geotextile clogging, and settlement problems.

- Potential Contamination – Prevent natural or fill soils from intermixing with the aggregate. Remove all contaminated aggregate and replace with uncontaminated aggregate.
- Overlap – Following the stone aggregate placement, fold the geotextile over the stone aggregate to form a 12-inch minimum longitudinal overlap. When geotextile overlaps are required between rolls, overlap the upstream roll a minimum of 2 feet over the downstream roll in order to provide a shingled effect.

5.4.17.7 Operations and Maintenance

[Remove debris and sediment from the drywell grate on a semi-annual basis, or as required to prevent the buildup of materials that could inhibit infiltration.](#) General maintenance requirements for infiltration [BMP facilities](#) apply to drywells; ~~refer to see~~ [BMP T7.50 in Volume V, Chapter 5 of the Ecology Manual.](#)

5.4.18 Compost-amended Vegetated Filter Strips (CAVFS)

5.4.18.1 BMP Description

[The compost-amended vegetated filter strip \(CAVFS, BMP T7.40 in Volume V, Chapter 7 of the Ecology Manual\) is a variation of BMP T9.40: Vegetated Filter Strip that adds soil amendments to the roadside embankment \(See Example of a Compost Amended Vegetated Filter Strip \(CAVS\) figure in Volume V, Chapter 7 of the Ecology Manual in Volume V, Chapter 7 of the Ecology Manual\).](#) ~~The CAVFS is a variation of the basic vegetated filter strip that adds soil amendments to the roadside embankment.~~ The soil amendments improve infiltration characteristics, increase surface roughness, and improve plant sustainability. Once permanent vegetation is established, the advantages of the CAVFS are higher surface roughness; greater retention and infiltration capacity; improved removal of soluble cationic contaminants through sorption; improved overall vegetative health; and a reduction of invasive weeds. ~~Compost-amended systems~~ [CAVFS](#) have somewhat higher construction costs [than BMP T9.40: Vegetated Filter Strip \(Volume V, Chapter 7 of the Ecology Manual\)](#) due to more expensive materials, but require less land area for runoff treatment, which can reduce overall costs.

5.4.18.2 Performance Mechanism

CAVFS remove pollutants primarily by filtration as stormwater moves through the grass blades. This enhances sedimentation and traps pollutants which adhere to the grass and thatch. Pollutants can also be adsorbed by the underlying soil when infiltration occurs, but the extent of infiltration depends on the type of soil, the density of grass, and the slope of the filter strip.

5.4.18.3 Application and Limitations

CAVFS can be used to meet basic runoff treatment and enhanced runoff treatment objectives [\(see Table 5.21\)](#). It has practical application in areas where there is space for roadside embankments that can be built to the CAVFS specifications. ~~This BMP can be applied to meet the requirements listed below.~~

Table 5.21. CAVFS Applicability

BMP	MR #5: On-site Stormwater Management		MR #6: Runoff Treatment				MR #7: Flow Control
	List	LID Performance Standard	Basic	Enhanced	Oil Control	Phosphorus	
CAVFS			X	X			

5.4.18.4 Site Considerations

The maximum lateral slope from adjacent roadway drainage area is 5%, and the lateral slope of the CAVFS itself must shall be between 2% and 25%. A gravel or crushed surfacing level spreader is also required between the roadway drainage area and the CAVFS.

5.4.18.5 Design Information

The CAVFS design incorporates composted material into the native soils per the criteria in BMP T5.13: Post-Construction Soil Quality and Depth for turf areas. However, the compost shall not contain biosolids or manure. The goal is to create a healthy soil environment for a lush growth of turf. Refer to See BMP T7.40 in Volume V, Chapter 7 of the Ecology Manual for detailed design information and guidance for a CAVFS, including information on allowable slopes, level spreader, and soil design.

BMP T7.40 in Volume V, Chapter 7 of the Ecology Manual provides guidance on Runoff Model Representation.

5.4.18.6 Minimum Construction Requirements

Minimum construction requirements associated with ~~filter strips~~ CAVFS include the following:

- Do not put CAVFS into operation until areas of exposed soil in the contributing drainage areas have been sufficiently stabilized. Deposition of eroded soils can impede the growth of grass in the filter strip and reduce treatment effectiveness. Erosion and sediment control measures shall remain in place until the CAVFS vegetation is established.
- Avoid compaction of the CAVFS areas during construction.

5.4.18.7 Operations and Maintenance

Refer to See BMP T7.40 in Volume V, Chapter 7 and Volume V, Appendix V-A of the Ecology Manual for required maintenance practices for CAVFS.

5.4.19 Sand Filters

5.4.19.1 BMP Description

Sand filters are used to provide runoff water quality treatment. The following three sand filter BMPs are described in this section:

- Sand Filter Basins ([BMP T8.10: Basic Sand Filter Basin and BMP T8.11: Large Sand Filter Basin in Volume V, Chapter 6 of the Ecology Manual](#)) - Like an infiltration basin, the sand filter basin is an impoundment that temporarily stores stormwater runoff so that it can infiltrate, but instead of infiltrating through the underlying soil, stormwater passes through a constructed sand bed. Sand filters can be sized as either a basic or a large [facilityBMP](#) to meet different water quality objectives. Sand filter basins are designed with underdrains to collect and route runoff following treatment to the downstream conveyance system.
- Sand Filter Vaults ([BMP T8.20 in Volume V, Chapter 6 of the Ecology Manual](#)) - A sand filter vault is similar to a sand filter basin, except that the entire [facilityBMP](#) is installed below grade in a vault. It typically consists of a pre-settling cell (if pretreatment is not already provided; ~~See [BMP T8.20 – Sand Filter Vault in Volume V of the Ecology Manual](#)~~) and a sand filtration cell. Like a sand filter basin, a vault can be sized as either a basic or a large [facilityBMP](#) to meet different water quality objectives.
- Linear Sand Filters ([BMP T8.30 in Volume V, Chapter 6 of the Ecology Manual](#)) - Linear sand filters are similar to sand filter vaults, except the vault is configured as a long, shallow, linear system. The vault contains two cells or chambers, one for removing coarse sediment and the other containing sand overlying an underdrain. Runoff usually enters the settling chamber as unconcentrated flow from an adjacent area and overflows to a central weir into the sand portion of the vault.

For additional filtration treatment [facilityBMP](#) types, [refer to Chapter 8 of Volume V of the Ecology Manual and Emerging Technologies in Section 5.4.30 of this manual](#) ~~see [BMP T8.40: Media Filter Drain in Volume V, Chapter 6 of the Ecology Manual](#)~~.

5.4.19.2 Performance Mechanism

Sand filters treat stormwater primarily via physical filtration. As stormwater passes through the sand media, pollutants are trapped in the small spaces between sand grains, or adhere to the sand surface. Over time, soil bacteria may also grow in the sand bed and some biological removal may occur.

Sand filter media can also be amended with steel fiber, crushed calcitic limestone, and/or other approved amendments to increase dissolved metals removal.

5.4.19.3 Application and Limitations

Use a sand filter basin to capture and treat the Water Quality Design Storm volume; which is 91% of the total runoff volume as predicted by an approved continuous simulation model (See Volume I, Section 4.2.6). Only 9% of the total runoff volume would bypass or overflow from the sand filter [facilityBMP](#).

The large sand filter is generally subject to the same applications and limitations as sand filter basin. The difference is that the large sand filter basin uses a higher Water Quality Design Storm volume: 95% of the runoff volume of the period modeled in an approved continuous simulation model. Only 5% of the total runoff volume as modeled would bypass or overflow from the sand filter [facilityBMP](#).

For sand filter vaults:

- Use where space limitations preclude above ground [BMPsfacilities](#).
- Not suitable where high water table and heavy sediment loads are expected.
- An elevation difference of 4 feet between inlet and outlet is needed.

For linear sand filters:

- Applicable in long narrow spaces such as the perimeter of a paved surface.
- As a part of a treatment train as downstream of a filter strip, upstream of an infiltration system, or upstream of a wetpond or a biofilter for oil control. Note, the linear sand filter is used in the Basic, Enhanced, and Phosphorus Treatment menus also. If used to satisfy one of those treatment requirements, the same [BMPfacility](#) shall not also be used to satisfy the oil control requirement unless increased maintenance is assured. This increase in maintenance is to prevent clogging of the filter by oil so that it will function for suspended solids, metals and phosphorus removal as well. Quarterly cleaning is required unless specified otherwise by the designer.
- To treat small drainages (less than 2 acres of impervious area).
- To treat runoff from high-use sites for TSS and oil/grease removal, if applicable.

Off-line sand filters shall be located upstream of detention [BMPsfacilities](#) whenever feasible.

On-line sand filters shall be located downstream of detention [BMPsfacilities](#) to prevent exposure of the sand filter surface to high flow rates that could cause loss of media and previously removed pollutants. [See Table 5.22 for a summary of runoff treatment requirements that sand filter BMPs can be designed to meet](#)~~The various sand filtration BMPs can be applied to meet the requirements listed below.~~

Table 5.22. Sand Filter BMPs [Applicability](#)

BMP	MR #5: On-site Stormwater Management		MR #6: Runoff Treatment				MR #7: Flow Control
	List	LID Performance Standard	Basic	Enhanced	Oil Control	Phosphorus	
Basic Sand Filter			X	X ^a		X ^b	
Large Sand Filter			X	X		X	
Sand Filter Vault			X	X ^a		X ^b	
Linear Sand Filter			X	X ^a	X ^c	X ^b	

Notes:

- Can be used to meet enhanced runoff treatment requirement as part of a two-~~facility~~[BMP](#) treatment train; [see Volume III, Section 1.2 of the Ecology Manual](#)~~Volume V of the Ecology Manual, Section 3.4.~~

- b. Can be used to meet phosphorus runoff treatment requirement as part of a two-~~facility~~BMP treatment train; ~~refer to see Volume III, Section 1.2 of the Ecology Manual~~~~Volume V of the Ecology Manual, Section 3.3.~~
- c. Can be used to meet oil control requirement (~~see Volume III, Section 1.2 of the Ecology Manual~~) as part of a two-~~facility~~BMP treatment train, if used downstream of a filter strip (~~see Volume II, Section 5.4.21~~), upstream of an infiltration system, or upstream of a wetpond (~~see Volume II, Section 5.4.22~~)~~or a biofilter (Ecology Manual, Volume V, Chapter 9)~~. If used to meet basic, enhanced, or phosphorus treatment requirements, the same BMP~~facility~~ cannot be used to meet oil control requirements unless provisions are made for additional maintenance.

5.4.19.4 Site Considerations

Consider the following site characteristics when siting a sand filtration system:

- Space availability, including a pre-settling basin (~~Refer to~~~~See~~ [BMP T8.10:— Basic Sand Filter Basin](#), [BMP T8.11:— Large Sand Filter Basin](#), [BMP T8.20:— Sand Filter Vault](#), and [BMP T8.30:— Linear Sand Filter](#) in Volume V, [Chapter 6](#) of the Ecology Manual).
- Sufficient hydraulic head, at least 4 feet from inlet to outlet (~~except for BMP T8.30:— Linear Sand Filter in Volume V, Chapter 6 of the Ecology Manual~~).
- Adequate Operation and Maintenance capability including accessibility for maintenance.
- Sufficient pretreatment of oil, debris and solids in the tributary runoff.

5.4.19.5 Design Information

~~See~~ [BMP T8.10:— Basic Sand Filter Basin](#), [BMP T8.11:— Large Sand Filter Basin](#), [BMP T8.20:— Sand Filter Vault](#), and [BMP T8.30:— Linear Sand Filter](#) in [Volume V, Chapter 6 of the Ecology Manual](#) for design requirements related to sand filters.

Pre-settling is required to prevent clogging and extend the service life of the filter media.

5.4.19.6 Minimum Construction Requirements

No runoff shall enter the sand filter prior to completion of construction and approval of site stabilization by the responsible inspector. Construction runoff may be routed to a pretreatment sedimentation ~~facility~~BMP, but discharge from sedimentation ~~BMPs~~facilities shall ~~bypass~~~~by-pass~~ downstream sand filters. Careful level placement of the sand is necessary to avoid formation of voids within the sand that could lead to short-circuiting, (particularly around penetrations for underdrain cleanouts) and to prevent damage to the underlying geomembranes and underdrain system. Over-compaction shall be avoided to ensure adequate filtration capacity. Sand is best placed with a low ground pressure bulldozer (4 pounds per square inch gage [psig] or less). After the sand layer is placed water settling is recommended. Flood the sand with 10-15 gallons of water per cubic foot of sand.

5.4.19.7 Operations and Maintenance

Refer to [BMP T8.20 in Volume V, Chapter 6 and Volume V, Appendix V-A of the Ecology Manual](#) for required maintenance practices for both above grade and below ground sand filter BMPs.

5.4.20 Media Filter Drains

5.4.20.1 **BMP Description**

The media filter drain (MFD, [BMP T8.40 in Volume V, Chapter 6 of the Ecology Manual](#)~~BMP T8.40 in Volume V, Chapter 6 of the Ecology Manual~~), previously referred to as the ecology embankment, is a linear flow-through stormwater runoff treatment device that can be sited along highway side slopes (conventional design) and medians (dual media filter drains), borrow ditches, or other linear depressions. Cut-slope applications may also be considered. MFDs can be used where available right of way is limited, sheet flow from the highway surface is feasible, and lateral gradients are generally less than 25% (4H:1V). MFDs have a General Use Level Designation (GULD) for basic, enhanced, and phosphorus treatment ([see Volume V, Chapter 10 of the Ecology Manual for more information about the TAPE approval process](#)).

Updates/changes to the use-level designation and any design changes will be posted in the Post-publication Updates section of the [Washington State Department of Transportation's Highway Runoff Manual Resource web page](#).

MFDs have four basic components: a gravel no-vegetation zone, a grass strip, the MFD mix bed, and a conveyance system for flows leaving the MFD mix. This conveyance system usually consists of a gravel-filled underdrain trench or a layer of crushed surfacing base course (CSBC). This layer of CSBC must be porous enough to allow treated flows to freely drain away from the MFD mix.

5.4.20.2 **Performance Mechanism**

MFDs remove suspended solids, phosphorus, and metals from highway runoff through physical straining, ion exchange, carbonate precipitation, and biofiltration.

[Runoff flowing through a MFD goes through the following treatment steps:](#)

1. Stormwater runoff enters the MFD and is conveyed via sheet flow over a vegetation-free gravel zone to ensure sheet dispersion and provide some pollutant trapping.
2. Next, a grass strip, which may be amended with composted material, is incorporated into the top of the fill slope to provide pretreatment, further enhancing filtration and extending the life of the system.
3. The runoff is then filtered through a bed of porous, alkalinity-generating granular medium—the MFD mix. MFD mix is a fill material composed of crushed rock (sized by screening), dolomite, gypsum, and perlite. The dolomite and gypsum additives serve to buffer acidic pH conditions and exchange light metals for heavy metals. Perlite is incorporated to improve moisture retention, which is critical for the formation of biomass epilithic biofilm to assist in the removal of solids, metals, and nutrients.
4. Treated water drains from the MFD mix bed into the conveyance system below the MFD mix. Geotextile lines the underside of the MFD mix bed and the conveyance system.

[The underdrain trench is an option for hydraulic conveyance of treated stormwater to a desired location, such as a downstream Flow Control BMP or stormwater outfall. The trench's perforated underdrain pipe is a protective measure to ensure free flow through the media filter drain mix and to prevent prolonged ponding. It may be possible to omit](#)

[the underdrain pipe if it can be demonstrated that the pipe is not necessary to maintain free flow through the MFD mix and underdrain trench.](#)

5.4.20.3 Application and Limitations

In many instances, conventional runoff treatment is not feasible due to right of way constraints (such as adjoining wetlands and geotechnical considerations). The MFD and the dual MFD designs are runoff treatment options that can be sited in most right of way confined situations. In many cases, a MFD or a dual MFD can be sited without the acquisition of additional right of way needed for conventional stormwater [BMPsfacilities](#) or capital-intensive expenditures for underground wetvaults.

[MFD BMPs can be designed to meet basic and enhanced runoff treatment requirements \(see Table 5.23\). See additional detailed guidelines on MFD applications and limitations in BMP T8.40 in Volume V, Chapter 6 of the Ecology Manual. This BMP can be applied to meet the requirements listed in the table below.](#)

Table 5.23. MFD Applicability

BMP	MR #5: On-site Stormwater Management		MR #6: Runoff Treatment				MR #7: Flow Control
	List	LID Performance Standard	Basic	Enhanced	Oil Control	Phosphorus	
Media Filter Drain			X	X			

5.4.20.4 Site Considerations

Since maintaining sheet flow across the MFD is required for its proper function, the ideal locations for MFDs in highway settings are highway side slopes or other long, linear grades with lateral side slopes less than 4H:1V and longitudinal slopes no steeper than 5%. As side slopes approach 3H:1V, without design modifications, sloughing may become a problem due to friction limitations between the separation geotextile and underlying soils. The longest flow path from the contributing area delivering sheet flow to the MFD shall not exceed 150 feet.

If there is sufficient roadway embankment width, the designer shall consider placing the grass strip and media mix downslope when feasible. The project office shall ensure the MFD does not intercept seeps, springs, or ground water.

The dual MFD is fundamentally the same as the side-slope version. It differs in siting and is more constrained with regard to drainage options. Prime locations for dual MFDs in a highway setting are medians, roadside drainage or borrow ditches, or other linear depressions. It is especially critical for water to sheet flow across the dual MFD. Channelized flows or ditch flows running down the middle of the dual MFD (continuous off-site inflow) shall be minimized.

Additional site considerations include:

- Steep slopes - Avoid construction on longitudinal slopes steeper than 5%. Avoid construction on 3H:1V lateral slopes, and preferably use less than 4H:1V slopes. In areas where lateral slopes exceed 4H:1V, it may be possible to construct terraces to create 4H:1V slopes or to otherwise stabilize up to 3H:1V slopes. (For details, see Geometry, Components and Sizing Criteria, Cross Section in the Structural Design Considerations section below).
- Wetlands - Do not construct in wetlands and wetland buffers. In many cases, a MFD (due to its small lateral footprint) can fit within the highway fill slopes adjacent to a wetland buffer. In those situations where the highway fill prism is located adjacent to wetlands, an interception trench/underdrain will need to be incorporated as a design element in the MFD.
- Shallow ground water - Mean high water table levels at the project site need to be determined to ensure the MFD mix bed and the underdrain (if needed) will not become saturated by shallow ground water.
- Unstable slopes - In areas where slope stability may be problematic, consult a geotechnical engineer.
- Areas of seasonal ground water inundations or basement flooding: Site-specific piezometer data may be needed in areas of suspected seasonal high ground water inundations. The performance of the dual media filter drain may be compromised due to backwater effects and lack of sufficient hydraulic gradient.
- Narrow roadway shoulders - In areas where there is a narrow roadway shoulder that does not allow enough room for a vehicle to fully stop or park, consider placing the MFD farther down the embankment slope. This will reduce the amount of rutting in the MFD and decrease overall maintenance repairs.

5.4.20.5 Design Information

Refer to [BMP T8.40 in Volume V, Chapter 6 of the Ecology Manual](#) for detailed design guidance and criteria on MFDs. [Design information is provided for the following components of design:](#)

[Flows to be treated](#)

[Geometry](#)

[Grass strip](#)

[Media Filter Drain Mix Bed](#)

[Underdrain](#)

[Vegetation](#)

5.4.20.6 Minimum Construction Requirements

Keep effective erosion and sediment control measures in place until grass strip is established. Do not allow vehicles or traffic on the MFD to minimize rutting and maintenance repairs.

5.4.20.7 Operations and Maintenance

Refer to [BMP T8.40 in Volume V, Chapter 6](#) ~~BMP T8.40 in Volume V, Chapter 6~~ and [Volume V, Appendix V-A of the Ecology Manual](#) for required maintenance practices for MFDs.

5.4.21 Basic-Vegetated Filter Strips

5.4.21.1 BMP Description

A vegetated basic filter (BMP T9.40 in Volume V, Chapter 7 of the Ecology Manual) strip is flat with no side slopes (see Typical Filter Strip figure in Volume V, Chapter 7 of the Ecology Manual in Volume V, Chapter 7 of the Ecology Manual). Contaminated stormwater is distributed as sheet flow across the inlet width of the vegetated filter strip. Runoff treatment is provided by passage of water over the surface and through grass slopes. Influent stormwater runoff is distributed as sheet flow across the inlet width of a biofilter strip.

5.4.21.2 Performance Mechanism

Filter strips remove pollutants primarily by filtration as stormwater moves through the grass blades. This enhances sedimentation and traps pollutants which adhere to the grass and thatch. Pollutants can also be adsorbed by the underlying soil when infiltration occurs, but the extent of infiltration depends on the type of soil, the density of grass, and the slope of the filter strip.

5.4.21.3 Application and Limitations

The vegetated basic filter strip is typically used adjacent and parallel to paved areas such as parking lots, driveways, and roadways and may be used to fully or partially satisfy basic or enhanced runoff treatment requirements (see Table 5.24). This BMP can be applied to meet the requirements listed below.

Table 5.24. Basic-Vegetated Filter Strip Applicability

BMP	MR #5: On-site Stormwater Management		MR #6: Runoff Treatment ^a				MR #7: Flow Control
	List	LID Performance Standard	Basic	Enhanced	Oil Control	Phosphorus	
<u>Vegetated Basic Filter Strip</u>			X	X ^a			

Notes:

- a. Can be used to meet enhanced runoff treatment requirement as part of a two-facility BMP treatment train; refer to see Volume III, Section 1.2 in the Ecology Manual.

5.4.21.4 Site Considerations

The maximum lateral and longitudinal slope from adjacent roadway drainage area is 5% and 2%, respectively, and the lateral slope of the basic filter strip itself must shall be between 1% and 15%. A gravel or crushed surfacing level spreader is also required between the roadway drainage area and the basic filter strip.

5.4.21.5 Design Information

Refer to BMP T9.40 in Volume V, Chapter 7 of the Ecology Manual for vegetated filter strip design criteria and procedures.

5.4.21.6 Minimum Construction Requirements

Minimum construction requirements associated with filter strips include the following:

- Do not put filter strips into operation until areas of exposed soil in the contributing drainage areas have been sufficiently stabilized. Deposition of eroded soils can impede the growth of grass in the filter strip and reduce treatment effectiveness. Erosion and sediment control measures shall remain in place until the filter strip vegetation is.
- Avoid compaction of the filter strip areas during construction.

5.4.21.7 Operations and Maintenance

Refer to [BMP T9.40 in Volume V, Chapter 7](#) and [BMP T9.40 in Volume V, Chapter 7 and Volume V, Appendix V-A of the Ecology Manual](#) for required maintenance practices for [vegetated](#) basic filter strips.

5.4.22 Wetponds

5.4.22.1 BMP Description

Wetponds ([BMP T10.10: Wetponds – Basic and Large in Volume V, Chapter 8 of the Ecology Manual](#)) are constructed stormwater ponds that retain a permanent pool of water (i.e., a wetpool or dead storage) at least during the wet season. [The volume of the wetpool is related to the effectiveness of the pond in settling particulate pollutants. As an option, a shallow marsh area can be created within the permanent pool volume to provide additional treatment for nutrient removal. Peak flow control can be provided in the "live storage" area above the permanent pool. Wetpond \(Plan View\) and Wetpond \(Section View\) in Volume V, Chapter 8 of the Ecology Manual illustrate a typical wetpond BMP.](#)

As an option, a shallow marsh area can be created within the permanent pool volume to provide additional treatment for nutrient removal. Peak control can be provided in the live storage area above the permanent pool.

5.4.22.2 Performance Mechanism

The volume of the wetpool, which slows down the velocity of influent stormwater, allows particulates and particulate-bound pollutants to settle and is a key factor in determining wetpond effectiveness. Biological uptake also acts as a secondary pollutant removal mechanism.

5.4.22.3 Application and Limitations

[A wetpond requires a larger area than a sand filter \(see Volume V, Chapter 6 of the Ecology Manual\), but it can be integrated to the contours of a site fairly easily. In till soils, the wetpond holds a permanent pool of water that provides an attractive aesthetic feature. In more porous soils, wetponds may still be used, but water seepage from unlined cells could result in a dry pond, particularly in the summer months. Lining the first cell with a low permeability liner \(see Volume V, Section 1.3.3 of the Ecology Manual\) is one way to deal with this situation. As long as the first cell retains a permanent pool of water, the pond will function as an effective Runoff Treatment BMP.](#)

Wetponds work best when the water already in the pond is moved out en masse by incoming flows, a phenomenon called "plug flow." Because treatment works on this displacement principle, the wetpool storage of wetponds may be provided below the ground water level without interfering unduly with treatment effectiveness. However, if combined with a detention function, the live storage shall be above the seasonal high ground water level.

~~A wetpond requires a larger area than a bioretention swale or a sand filter, but it can be integrated to the contours of a site fairly easily. In till soils, the wetpond holds a permanent pool of water that provides an attractive aesthetic feature. In more porous soils, wetponds may still be used, but water seepage from unlined cells could result in a dry pond, particularly in the summer months. Lining the first cell with a low permeability liner is one way to deal with this situation. As long as the first cell retains a permanent pool of water, this situation will not reduce the pond's effectiveness but may be an aesthetic drawback.~~

~~Wetponds work best when the water already in the pond is moved out en masse by incoming flows, a phenomenon called "plug flow." Because treatment works on this displacement principle, the wetpool storage of wetponds may be provided below the ground water level without interfering unduly with treatment effectiveness. However, if combined with a detention function, the live storage must be above the seasonal high ground water level.~~

Wetponds may be single-purpose BMPsfacilities, providing only runoff treatment, or they may be combined with a detention pond to also provide flow control. If combined, the wetpond can often be stacked under the detention pond with little further loss of development area. Refer to Volume II, Section 5.4.29 for a description of combined detention and wetpool BMPsfacilities. See Table 5.25 for a summary of runoff treatment requirements that wetpond BMPs can be designed to meet.

Table 5.25. Wetponds Applicability

BMP	MR #5: On-site Stormwater Management		MR #6: Runoff Treatment				MR #7: Flow Control
	List	LID Performance Standard	Basic	Enhanced	Oil Control	Phosphorus	
Basic Wetpond			X	X ^b		X ^c	
Large Wetpond ^a			X	X		X	

Notes:

- a. A large wetpond requires a wetpool volume at least 1.5 times greater than for a basic wetpond.
- b. Can be used to meet enhanced runoff treatment requirement as part of a two-facilityBMP treatment train; Volume III, Section 1.2 in the Ecology ManualVolume V of the Ecology Manual, Section 3.4.
- c. Can be used to meet phosphorus runoff treatment requirement as part of a two-facilityBMP treatment train; refer tosee Volume III, Section 1.2 in the Ecology ManualVolume V of the Ecology Manual, Section 3.3.

5.4.22.4 Site Considerations

~~As noted above, wW~~etponds require a larger area than a bioretention swale or a sand filter, but can be integrated into the contours of a site fairly easily and function well for any size project. The following considerations apply to siting of wetponds:

- The location of the wetpond relative to site constraints (e.g., buildings, property lines, etc.) shall be the same as for detention ponds ([Volume II, Section 5.4.26](#)).
- Access and maintenance roads shall be provided and designed according to the requirements for detention ponds ([Volume II, Section 5.4.26](#))
- Access and maintenance roads shall extend to both the wetpond inlet and outlet structures.
- An access ramp (7H minimum:1V) shall be provided to the bottom of the first cell unless all portions of the cell can be reached, and sediment loaded from the top of the pond. ~~Also~~ See [Volume II, Section 5.4.26, "Access Requirements"](#) for more information on access alternatives.
- If the dividing berm is also used for access, it ~~must~~shall be built to sustain loads of up to 80,000 pounds.

Refer to [BMP T10.10 in Volume V, Chapter 8 of the Ecology Manual](#) for additional wetpond siting requirements.

5.4.22.5 Design Information

Refer to [BMP T10.10 in Volume V, Chapter 8 of the Ecology Manual](#) for detailed design criteria. ~~Planting the wetpond is required by Kitsap County. See County-specific criteria include the following for the following components of wetponds:~~

~~Geometry~~

~~Berms and baffles~~

~~Pre-settling basin (see also Volume II, Section 5.4.14)~~

~~Overflow structure~~

~~Access~~

~~Vegetation and landscaping~~

~~See Appendix D of the Kitsap County Stormwater Pond Retrofit Design Guidance Manual (Herrera 2012) for a recommended plant list for wetponds.~~

~~Inlets and outlets~~

5.4.22.6 Minimum Construction Requirements

Minimum construction requirements include the following:

- Sediment that has accumulated in the pond ~~must~~shall be removed after construction in the drainage area of the pond is complete (unless used for a liner - see below).

- Sediment that has accumulated in the pond at the end of construction may be used in excessively drained soils to meet the liner requirements if the sediment meets the criteria for low permeability or treatment liners in keeping with guidance in [Volume V, Section 1.3 of the Ecology Manual](#).
- Sediment used for a soil liner mustshall be graded to provide uniform coverage and mustshall meet the thickness specifications in [Volume V, Section 1.3 of the Ecology Manual](#). The sediment mustshall not reduce the design volume of the pond. The pond mustshall be over-excavated initially to provide sufficient room for the sediments to serve as a liner.

5.4.22.7 Operations and Maintenance

Refer to [BMP T10.10 in Volume V, Chapter 8 and Volume V, Appendix V-A of the Ecology Manual](#) for required maintenance practices for wetponds.

5.4.23 Wetvaults

5.4.23.1 BMP Description

~~A Wwetvaults (BMP T10.20 in Volume V, Chapter 8 of the Ecology Manual) is an are underground structure similar in appearance to a detention vault, except that a wetvault has a permanent pool of water (wetpool) which dissipates energy and improves the settling of particulate pollutants (see the Wetvault figure in Volume V, Chapter 8 of the Ecology Manual). Being underground, the wetvault lacks the biological pollutant removal mechanisms, such as algae uptake, present in BMP T10.10: Wetponds - Basic and Large and BMP T10.30: Stormwater Treatment Wetlands in Volume V, Chapter 8 of the Ecology Manual. drainage facilities that contain permanent pools of water that are filled during the initial runoff from a storm event. They are similar to wetponds, except the wetpool is constructed below grade.~~

5.4.23.2 Performance Mechanism

Wetvaults are designed to provide ~~runoffwater quality~~ treatment by dissipating energy and providing retention time in order to settle out particulate pollutants. Being underground, the wetvault lacks the biological pollutant removal mechanisms, such as algae uptake, present in surface wetponds. Wetvaults are believed to be ineffective in removing dissolved pollutants such as soluble phosphorus or metals, such as copper ~~(Seattle 2016)~~. Therefore, use of wetvaults shall only be considered when other treatment BMPs are infeasible, and shall be approved by DCD on a case-by-case basis.

5.4.23.3 Application and Limitations

A wetvault may be used for commercial, industrial, or roadway projects if there are space limitations precluding the use of other treatment BMPs. The use of wetvaults for residential development is highly discouraged. Combined detention and wetvaults are allowed; ~~refer to see~~ [Volume II, Section 5.4.29](#).

A wetvault is believed to be ineffective in removing dissolved pollutants such as soluble phosphorus or metals such as copper. There is also concern that oxygen levels will decline,

especially in warm summer months, because of limited contact with air and wind. However, the extent to which this potential problem occurs has not been documented.

Below-ground structures like wetvaults are relatively difficult and expensive to maintain. The need for maintenance is often not seen and as a result routine maintenance does not occur.

If oil control is required for a project (see Volume I, Chapter 4.2.6), a wetvault may be combined with an American Petroleum Institute (API) oil/water separator; ~~refer to see~~ [Volume II, Section 5.4.235](#).

~~Wetvault BMPs can be designed to meet all runoff treatment requirements, including basic, enhanced, oil control, and phosphorus control (see Table 5.26). This BMP can be applied to meet the requirements listed below.~~

Table 5.26. Wetvaults Applicability

BMP	MR #5: On-site Stormwater Management		MR #6: Runoff Treatment				MR #7: Flow Control
	List	LID Performance Standard	Basic	Enhanced	Oil Control	Phosphorus	
Wetvault			X	X ^a	X ^b	X ^c	

Notes:

- a Can be used to meet enhanced runoff treatment requirement as part of a two-~~facility~~BMP treatment train; [see Volume III, Section 1.2 in the Ecology Manual](#).
- b Can be used to meet oil control ~~performance goal~~runoff treatment requirement if combined with API oil/water separator; see [Volume V, Chapter 13, BMP T11.10 in the Ecology Manual](#).
- c Can be used to meet phosphorus runoff treatment requirement as part of a two-~~facility~~BMP treatment train; ~~refer to see~~ [Volume III, Section 1.2 in the Ecology Manual](#)[Volume V of the Ecology Manual, Section 3-3](#).

5.4.23.4 Site Considerations

The following site considerations can help determine the feasibility of a wetvault for a particular site:

- Vault location and vault material approval is required, and may require geotechnical analysis.
- Location of the wetvault relative to site constraints (e.g., buildings, property lines) shall be the same as for detention ponds (see [Volume II, Section 5.4.26](#)).
- Consider wetvaults where there are space limitations precluding the use of other treatment BMPs.
- Consider how the wetvault grates and access points fit within a site plan, including restrictions for safety considerations and restriction of pollutants entering through grates. Grates shall not operate as inlets. Generally, the surrounding area shall be sloped away from grates.
- Consider how access will be provided for vactor trucks for sediment removal.

5.4.23.5 Design Information

As with wetponds, the primary design factor that determines the removal efficiency of a wetvault is the volume of the wetpool. The larger the volume, the higher the potential for pollutant removal. Performance is also improved by avoiding dead zones (like corners) where little exchange occurs, using large length-to-width ratios, dissipating energy at the inlet, and ensuring that flow rates are uniform to the extent possible and not increased between cells.

Refer to [BMP T10.20 in Volume V, Chapter 8 of the Ecology Manual](#) for detailed design guidance and criteria on wetvaults. ~~Design information is provided for the following components of design:~~

~~Wetvault geometry~~

~~Wetvault configuration~~

~~Inlet, outlet and bypass (if used)~~

~~Modifications if combining with a baffle oil/water separator~~

~~Modifications if combining with detention~~

~~Access to cells for maintenance~~

~~Structural requirements~~

5.4.23.6 Minimum Construction Requirements

Sediment that has accumulated in the vault ~~must~~shall be removed after construction in the drainage area is complete. If no more than 12 inches of sediment have accumulated after the infrastructure is built, cleaning may be left until after building construction is complete. In general, sediment accumulation from stabilized drainage areas is not expected to exceed an average of 4 inches per year in the first cell. If sediment accumulation is greater than this amount, it will be assumed to be from construction unless it can be shown otherwise.

5.4.23.7 Operations and Maintenance

Refer to [BMP T10.20 in Volume V, Chapter 8 of the Ecology Manual](#) for required maintenance practices for wetvaults.

5.4.24 Stormwater Treatment Wetlands

5.4.24.1 BMP Description

Stormwater treatment wetlands ([BMP T10.30 in Volume V, Chapter 8 of the Ecology Manual](#)) are similar to wetponds, but also provide a shallow marsh area to allow the establishment of emergent wetland aquatic plants, which improves pollutant removal. In land development situations, wetlands are usually constructed for two main reasons: to replace or mitigate impacts when natural wetlands are filled or impacted by development (mitigation wetlands), and to treat stormwater runoff (stormwater treatment wetlands). Stormwater treatment wetlands are shallow man-made ponds that are designed to treat stormwater through the biological processes associated with emergent aquatic plants.

5.4.24.2 Performance Mechanism

Stormwater treatment wetlands remove sediment, metals, and pollutants that bind to humic or organic acids primarily through settling and biological uptake. Secondary performance mechanisms include filtration and soil adsorption. Phosphorus removal in stormwater wetlands is highly variable; therefore, stormwater treatment wetlands are not expected to provide phosphorus control [as a stand-alone BMP and must be paired per the treatment train approach \(Seattle 2016\)](#).

5.4.24.3 Application and Limitations

This stormwater wetland design occupies about the same surface area as wetponds, but has the potential to be better integrated aesthetically into a site because of the abundance of emergent aquatic vegetation. The most critical factor for a successful design is the provision of an adequate supply of water for most of the year. Careful planning is needed to be sure sufficient water will be retained to sustain good wetland plant growth. Since water depths are shallower than in wetponds, water loss by evaporation is an important concern. Stormwater wetlands are a good runoff treatment [facilityBMP](#) choice in areas with high winter ground water levels.

Stormwater treatment wetlands can be combined with detention to provide flow control as well as runoff treatment; ~~refer to~~ [see Volume II, Section 5.4.29. As shown in Table 5.27, this BMP can be designed to meet basic, and enhanced requirements. If used as part of a two-BMP treatment train, stormwater treatment wetlands can also be designed to meet phosphorus runoff treatment requirements.](#)

~~This BMP can be applied to meet the requirements listed below.~~

Table 5.27. Stormwater Treatment Wetlands [Applicability](#)

BMP	MR #5: On-site Stormwater Management		MR #6: Runoff Treatment				MR #7: Flow Control
	List	LID Performance Standard	Basic	Enhanced	Oil Control	Phosphorus	
Stormwater Treatment Wetlands			X	X		X ^a	

Notes:

- a. Can be used to meet phosphorus runoff treatment requirement as part of a two-[facilityBMP](#) treatment train; refer to [Volume III, Section 1.2 in the Ecology Manual](#).

5.4.24.4 Site Considerations

The following site considerations can help determine the feasibility of a stormwater treatment wetland for a particular site:

- Location of the stormwater wetland relative to site constraints (e.g., buildings, property lines) shall be the same as for detention ponds; ~~refer to~~ [see Volume II, Section 5.4.26](#).

- Access and maintenance roads shall be provided and designed according to the requirements for detention ponds (see [BMP D.1 in Volume V, Chapter 12 of the Ecology Manual](#)). Access and maintenance roads shall extend to both the wetland inlet and outlet structures. An access ramp (7H minimum:1V) shall be provided to the bottom of the first cell unless all portions of the cell can be reached, and sediment loaded from the top of the wetland side slopes.
- If the dividing berm is also used for access, it shall be built to sustain loads of up to 80,000 pounds.

5.4.24.5 Design Information

When used for stormwater treatment, stormwater wetlands employ some of the same design features as wetponds. However, instead of gravity settling being the dominant treatment process, pollutant removal mediated by aquatic vegetation and the microbiological community associated with that vegetation becomes the dominant treatment process. Thus, when designing wetlands, water volume is not the dominant design criteria. Rather, factors which affect plant vigor and biomass are the primary concerns.

Refer to [See BMP T10.30 in Volume V, Chapter 8 of the Ecology Manual](#) for detailed design guidance and criteria, ~~for the following components of design:~~

~~Sizing procedures
Wetland geometry
Lining (if required)
Planting
Access~~

5.4.24.6 Minimum Construction Requirements

- Construction and maintenance considerations are the same as for wetponds (see [Volume II, Section 5.4.22](#)).
- Construction of the naturalistic alternative (see [BMP T10.30 in Volume V, Chapter 8 of the Ecology Manual](#)) can be easily done by first excavating the entire area to the 1.5-foot average depth. Then soil subsequently excavated to form deeper areas can be deposited to raise other areas until the distribution of depths indicated in the design is achieved.

5.4.24.7 Operations and Maintenance

- [Stormwater treatment](#) wetlands shall be inspected at least twice per year during the first three years during both growing and non-growing seasons to observe plant species presence, abundance, and condition; bottom contours and water depths relative to plans; and sediment, outlet, and buffer conditions. [Coordinate with Kitsap County to develop a monitoring plan.](#)
- Maintenance shall be scheduled around sensitive wildlife and vegetation seasons.
- Plants may require watering, physical support, mulching, weed removal, or replanting during the first three years.

- Nuisance plant species shall be removed, and desirable species shall be replanted.
- The effectiveness of harvesting for nutrient control is not well documented. There are many drawbacks to harvesting, including possible damage to the wetlands and the inability to remove nutrients in the below-ground biomass. If harvesting is practiced, it shall be done in the late summer.

5.4.25 Oil/Water Separators

5.4.25.1 **BMP Description**

The purpose of oil and water separator BMPs is to remove oil and other water-insoluble hydrocarbons, and settleable solids from stormwater runoff. Oil and water separator BMPs typically consist of three bays: a forebay, a separator ~~bay~~section, and an afterbay.

There are two general types of oil and water separators ~~are typically the:~~

- the American Petroleum Institute (API) type (also called baffle type) (API, 1990)
 - API separators are composed of three bays separated by baffles. The efficiency of API separators is dependent on detention time in the center bay and on droplet size. API type separators rarely treat stormwater to reduce oil levels below 10 milligrams per liter (mg/L). The use of API separators should be limited to protection from large oil spills and not for small amounts of oil on the pavement surfaces. See BMP T11.10: API (Baffle type) Separator in Volume V, Chapter 13 of the Ecology Manual
- the coalescing plate (CP) type ~~using a gravity mechanism for separation.~~
 - CP separators use a series of parallel plates in the separator bay, which improve separation efficiency by providing more surface area. CP separators need considerably less space for separation of the floating oil due to the shorter travel distances between parallel plates. See BMP T11.11: Coalescing Plate (CP) Separator in Volume V, Chapter 13 of the Ecology Manual.

Both types of oil/water separators use gravity to remove floating and dispersed oil.

A spill control (SC) separator (see Spill Control Separator [not for oil treatment] figure in Volume V, Chapter 13 of the Ecology Manual) is a simple catch basin with a T-inlet for temporarily trapping small volumes of oil. The spill control separator is included here for comparison only and is not designed for, or to be used for treatment purposes.

5.4.25.2 **Performance Mechanism**

Oil and water separators are designed to ~~achieve-meet~~ the Oil Control ~~Runoff Treatment Performance Goal-standard~~, which is intended to achieve the following:

- No ongoing or recurring visible sheen~~;-~~
- A 24-hour average Total Petroleum Hydrocarbon (TPH) concentration ~~≤no greater than~~ 10 mg/L; ~~and-~~
- A maximum of 15 mg/L for a discrete sample (grab sample).

[See Volume III, Section 1.2 of the Ecology Manual for more information regarding the Oil Control Performance Goal.](#)

5.4.25.3 **Application and Limitations**

The following are potential applications of oil and water separators where free oil is expected to be present at treatable high concentrations and sediment will not overwhelm the separator.) For low concentrations of oil, other treatments may be more applicable. These include sand filters and [emerging technologies manufactured treatment devices and BMPs](#).

- Commercial and industrial areas including petroleum storage yards, vehicle maintenance facilities, manufacturing areas, airports, utility areas (water, electric, gas), and fueling stations.
- Facilities that would require oil control BMPs under the high-use site threshold described in [Chapter 2 of Volume II, Chapter 2 of this manual](#) including parking lots at convenience stores, fast food restaurants, grocery stores, shopping malls, discount warehouse stores, banks, truck fleets, auto and truck dealerships, and delivery services.
- Without intense maintenance oil/water separators may not be sufficiently effective in achieving oil and TPH removal down to required levels.
- A pretreatment BMP (see Volume V, Chapter 9 of the Ecology Manual) ~~shall~~ should be considered if the level of TSS in the inlet flow would cause clogging or otherwise impair the long-term efficiency of the [oil and water separator BMP](#).
- For inflows from small drainage areas ([such as](#) fueling stations, maintenance shops, etc.), [BMP T11.11: Coalescing Plate \(CP\) Separator](#) is typically considered, due to space limitations. However, if plugging of the plates is likely, then a new design basis for [BMP T11.10: API \(Baffle type\) Separator](#) may be considered on an experimental basis.

[Oil/water separators may only be used to provide oil control and may not be used to partially or fully satisfy any other minimum requirement \(see Table 5.28\).](#)

Table 5.28. Oil/Water Separators Applicability

BMP	MR #5: On-site Stormwater Management		MR #6: Runoff Treatment				MR #7: Flow Control
	List	LID Performance Standard	Basic	Enhanced	Oil Control	Phosphorus	
Oil/water separators					X		

5.4.25.4 **Site Considerations**

Consider the following site characteristics:

- Oil/water separators shall be installed upstream of other [Runoff Water Quality](#) Treatment BMPs (except wetvaults), pumps, and conveyance structures that introduce turbulence [and as close to the source of oil generation as possible](#).
- Oil/water separators may be located upstream or downstream of Flow Control BMPs.
- Oil/water separators shall be located off-line [from the primary conveyance/detention system, and bypassing flows greater than the incremental portion of flows that exceed the off-line 15-minute water quality design flow rate multiplied by the ratio indicated in the Ratio of SBUH Peak/WQ Flow \(Offline\) figure in Volume V, Chapter 7 of the Ecology Manual](#). If it is not possible to locate the separator off-line (e.g., roadway intersections), try to minimize the size of the area requiring oil control, and use the on-line water quality design flow rate [multiplied by the ratio indicated in the Ratio of SBUH Peak/WQ Flow \(Online\) figure in Volume V, Chapter 7 of the Ecology Manual](#).
- Oil/water separators shall not be used for removal of dissolved or emulsified materials such as coolants, soluble lubricants, glycols (anti-freeze), and alcohols. [If practicable, determine the oil/grease \(or TPH\) and TSS concentrations, lowest temperature, pH; and empirical oil rise rates in the runoff, and the viscosity, and specific gravity of the oil.](#)
- Oil/water separators are best located in areas where the contributing drainage area is nearly all impervious and a fairly high load of TPH is likely to be generated.
- Excluding unpaved areas helps to minimize the amount of sediment entering the vault, which reduces the need for maintenance.
- Sufficient land area is available for siting the oil/water separator.
- Adequate TSS control or pretreatment capability upstream of the oil/water separator. Pretreatment shall be considered if the level of TSS in the influent would cause clogging or otherwise impair the long-term efficiency of the separator.
- Adequate influent flow attenuation and/or bypass capability upstream of or integrated with the oil/water separator.
- Sufficient access for operation and maintenance.

5.4.25.5 Design Information

There is concern that oil/water separators used for stormwater treatment have not performed to expectations. Therefore, emphasis shall be given to proper application, design, operation and maintenance, (particularly sludge and oil removal) and prevention of CP fouling and plugging. Other treatment systems, such as sand filters ([Volume II, Section 5.4.19](#)) and [emerging manufactured treatment devices as BMP technologies](#) ([Volume II, Section 5.4.30](#)), shall be considered for the removal of insoluble oil and TPH.

[Refer to See BMP T11.10 in Volume V, Chapter 13 of the Ecology Manual](#) for detailed design guidance and criteria on API oil/water separators, and [BMP T11.11 in Volume V, Chapter 13 of the Ecology Manual](#) for detailed design guidance and criteria on CP oil/water separators.

5.4.25.6 **Minimum Construction Requirements**

The following are construction requirements associated with the construction of an oil/water separator:

- Follow the manufacturer’s recommended construction procedures and installation instructions, as well as any applicable [Kitsap County](#) requirements.
- Upon completion of installation, thoroughly clean and flush the oil/water separator prior to operation.
- Specify appropriate performance tests after installation and shakedown, and/or provide certification by a licensed engineer that the separator is functioning in accordance with design objectives.

5.4.25.7 **Operations and Maintenance**

~~Refer to~~ [See the Operation and Maintenance section in Volume V, Chapter 13 of the Ecology Manual and Volume V, Appendix V-A of the Ecology Manual](#) for required maintenance practices for oil/water separators.

5.4.26 **Detention Ponds**

Detention ponds ([BMP D.1 in Volume V, Chapter 12 of the Ecology Manual](#)) are basins that provide temporary storage of stormwater runoff resulting from development, and are designed to release flows at a controlled rate. Detention ponds can also be combined with [runoff treatment BMPswater quality facilities](#), as described further in [Volume II, Section 5.4.29](#).

5.4.26.1 **Performance Mechanisms**

Detention ponds provide peak flow attenuation and control of erosive flow durations by slowly releasing stored flows through an outlet control structure.

5.4.26.2 **Applications and Limitations**

Detention ponds can be designed to meet or partially meet the flow control requirement, MR #7 ([see Table 5.29](#)).

Table 5.29. Detention Ponds [Applicability](#)

BMP	MR #5: On-site Stormwater Management		MR #6: Runoff Treatment				MR #7: Flow Control
	List	LID Performance Standard	Basic	Enhanced	Oil Control	Phosphorus	
Detention Ponds							X

5.4.26.3 **Site Considerations**

Detention ponds generally require a large amount of area, and [mustshall](#) also include maintenance access roads to, around, and sometimes into the ponds.

The following setback requirements apply to detention ponds:

- The toe of the exterior slope of a detention pond berm embankment shall comply with the required grading setbacks per Volume II, Chapter 9, and shall be set back a minimum of 5 feet from the tract, easement, property line and any vegetative buffer required by the conditions of the land use approval.
- The tract, easement, or property line on a pond cut slope shall be set back a minimum of 10 feet from the emergency overflow water surface.
- Stormwater facilities shall comply with KPHD regulations for setbacks to on-site sewage systems, wells, and other features regulated by KPHD.
- All detention ponds shall be a minimum of 50 feet away from the top of any slope greater than 15% and a minimum of 200 feet from the top of any slope greater than or equal to 30%. These distances may be reduced based on recommendation and justification by a licensed geotechnical engineer. A geotechnical analysis and report ~~must~~shall be prepared addressing the potential impact of the ~~facility~~BMP on slopes 15% or greater or otherwise sensitive slopes. See report submittal requirements in Volume II, Chapter 1 ~~of this manual.~~

5.4.26.4 Design Information

~~Refer to~~See [BMP D.1 in Volume V, Chapter 12 of the Ecology Manual](#) for detailed design guidance on detention ponds, ~~including the following components of design:~~ [Fencing shall be installed according to the Ecology Manual with the following exceptions:](#)

- ~~• Determining required pond volume and release rates~~
- ~~• Side slopes~~
- ~~• Embankments~~
- ~~• Overflow (including emergency overflow spillways)~~
- ~~• Access~~
- ~~• Bench at Fence Line: A minimum of 5 feet flat bench area with the fencing placed in the middle shall be required for all fencing around ponds where the slope is 3H:1V or greater.~~
- ~~•~~
- ~~• Fence material shall not be green vinyl.~~

[Note that the use of AutoPond in the Western Washington Hydrology Model \(WWHM\) may not result in a buildable pond that would meet the control structure requirements in Volume V, Section 12.2 of the Ecology Manual. Sizing results from AutoPond shall be compared against the applicable design requirements and pond dimensions shall be modified as needed to meet the requirements.](#)

5.4.26.5 Minimum Construction Requirements

The following construction requirements shall be considered during construction of a detention pond:

- Detention ponds may be used for sediment control during site construction, but sediment shall be removed upon completion.
- Exposed earth on the pond bottom and interior side slopes shall be vegetated or seeded with an appropriate seed mixture.

5.4.26.6 Operations and Maintenance Requirements

Maintenance activities and frequencies for detention ponds are provided in [BMP D.1 in Volume V, Chapter 12 of the Ecology Manual and Volume V, Appendix V-A of the Ecology Manual](#).

[Handle any standing water and sediments removed during the maintenance operation in a manner consistent with Appendix IV-B of the Ecology Manual.](#)

5.4.27 Detention Pipes/Tanks

5.4.27.1 BMP Description

[Detention tanks are underground detention BMPs typically constructed with large diameter corrugated metal pipe. Standard detention tank details are shown in the Typical Detention Tank and Detention Tank Access Detail figures in Volume V, Chapter 12 in the Ecology Manual. Control structure details are shown in Volume V, Section 12.2 in the Ecology Manual.](#)
~~Detention pipes are underground storage pipes that provide temporary storage of stormwater runoff from developed sites, designed to release flows at a controlled rate.~~

5.4.27.2 Performance Mechanism

Detention ~~pipes~~ tanks provide peak flow attenuation and control of erosive flow durations by storing and slowly releasing stored flows through an outlet control structure.

5.4.27.3 Application and Limitations

Detention ~~pipes~~ tanks can be applied to ~~meet or partially meet the requirements listed below~~ partially or fully satisfy flow control requirements (see Table 5.30).

Table 5.30. Detention Pipes/Tank Applicability

BMP	MR #5: On-site Stormwater Management		MR #6: Runoff Treatment				MR #7: Flow Control
	List	LID Performance Standard	Basic	Enhanced	Oil Control	Phosphorus	
Detention Pipe/Tank							X

5.4.27.4 Site Considerations

The primary site considerations for detention ~~pipes~~ tanks include conflicts with existing underground utilities and required setbacks, as follows:

- Detention ~~pipes-tanks~~ shall be a minimum of 20 feet from any structure, property line, and any vegetative buffer required by conditions of land use approval, [Title 19 KCC](#) or other applicable codes.
- All detention tanks ~~must~~shall be a minimum of 50 feet from the top of any slope greater than 15%. A geotechnical analysis and report ~~must~~shall be prepared addressing the potential impact of the ~~facility~~BMP on a steep slope to support setbacks less than 50 feet. See report submittal requirements in Volume II, Chapter 1-~~of this manual~~.

5.4.27.5 Design Information

~~Refer to~~See [BMP D.2 in Volume V, Chapter 12 of the Ecology Manual](#) for detailed design guidance and criteria ~~on detention pipes (called detention tanks in the Ecology Manual)~~. [The Engineer shall provide buoyancy calculations to verify that the tank will not move due to floatation forces in the event of high ground water. An appropriate factor of safety shall be used.](#) ~~Design information is provided for the following components of design:~~

~~Materials
Pipe bedding
Structural stability
Access~~

5.4.27.6 Minimum Construction Requirements

Construction requirements are as follows:

- Place at least 4 inches of bedding under the ~~pipe~~tank. The bedding shall fill the trench to a point half-way up the sides of the ~~pipe-tank~~ (to the “spring line”).
- Provide at least 2 feet of cover over a detention ~~pipe~~tank. For single-family and duplex residences, 18 inches of cover is allowable. Prior to permit issuance, a Kitsap County inspector shall approve the installed system, including the detention pipe and the flow control structure, after it is bedded but before it is covered with soil.
- ~~The standard slope for detention pipes-tanks is 0.5%. The inlet pipe to the detention pipe tank and the outlet pipe from the flow control structure shall have at least a 2% slope.~~
- [Follow the manufacturer’s recommendations if backfill and bedding requirements are more stringent than the requirements in this section.](#)

Field changes to the flow control device assembly, including elevation changes, require submittal to Kitsap County by the Engineer of Record, prior to installation, for confirmation that the device still meets the design requirements.

5.4.27.7 Operations and Maintenance

~~See~~Refer to [Volume V, Chapter 12, BMP D.2 and Volume V, Appendix V-A of the Ecology Manual](#) for required maintenance practices for closed detention systems, including detention ~~pipe~~tanks.

5.4.28 Detention Vaults

5.4.28.1 BMP Description

Detention vaults ([BMP D.3 in the Ecology Manual](#)) are box-shaped underground storage facilities typically constructed with reinforced concrete ([see Typical Detention Vault figure in Figure V-12.16: Typical Detention Vault in Volume V, Chapter 12 of the Ecology Manual](#)). [Control structure details are shown in V-12.2 Control Structure Design in Volume V, Chapter 12 of the Ecology Manual.](#)

5.4.28.2 Performance Mechanism

Detention vaults provide peak flow attenuation and control of erosive flow durations by storing and slowly releasing low flows through an outlet control structure.

5.4.28.3 Application and Limitations

[Detention vaults can be applied to partially or fully satisfy flow control requirements \(see Table 5.31\)](#)~~Detention vaults can be applied to meet or partially meet the requirements listed below.~~

Table 5.31. Detention Vaults Applicability

BMP	MR #5: On-site Stormwater Management		MR #6: Runoff Treatment				MR #7: Flow Control
	List	LID Performance Standard	Basic	Enhanced	Oil Control	Phosphorus	
Detention Vaults							X

5.4.28.4 Site Considerations

Detention vaults are typically shallower than detention pipes, since they can utilize a greater area. Primary site considerations for a detention vaults include providing sufficient access points for maintenance, incorporating the access requirements into a site, conflicts with existing underground utilities, and site setback requirements.

Detention vaults shall have the following minimum setbacks:

- 5 feet from tract or easement lines.
- 20 feet from any structure, property line, and any vegetative buffer required by conditions of land use approval, [Title 19 KCC](#) or other applicable codes.
- 50 feet from the top of any ~~steep~~ slope greater than 15%. A geotechnical analysis and report ~~must~~[shall](#) be prepared addressing the potential impact of the ~~facility~~[BMP](#) on a steep slope to support setbacks less than 50 feet. See report submittal requirements in Volume II, Chapter 1 ~~of this manual~~.

Grading and drainage collection on site are important site considerations that can impact flow control effectiveness. Special care is necessary, particularly with roadway projects, to match BMP sizing to actual runoff collected and conveyed to the [BMP facility](#).

5.4.28.5 Design Information

~~Refer to~~ See [Volume V, Chapter 12, BMP D.3 in the Ecology Manual](#) for detailed design guidance and criteria ~~_on the following components of detention vault design:~~

- ~~• [Materials](#)~~
- ~~• [Structural stability](#)~~
- ~~• [Access](#)~~

5.4.28.6 Minimum Construction Requirements

Refer to the construction-related issues outlined above as part of the design criteria. Additional construction requirements are as follows:

- Conduct infiltration or exfiltration testing of the detention vault.
- Submit field changes to the flow control device assembly, including elevation changes, to the Engineer of Record for confirmation that the device still meets the design requirements.

5.4.28.7 Operations and Maintenance

~~Refer to~~ See [Volume V, Chapter 12, BMP D.3 and Volume V, Appendix V-A of the Ecology Manual](#) for required maintenance practices for closed detention systems, including detention vaults.

5.4.29 Combined Detention and Wetpool Facilities

5.4.29.1 BMP Description

Combined detention and ~~water quality runoff treatment~~ wetpool facilities ([BMP T10.40 in the Ecology Manual](#)) have the appearance of a detention ~~facility~~ [BMP](#) but contain a permanent pool of water as well. Site considerations, setbacks, and other typical siting and design considerations for combined [BMPs](#) ~~facilities~~ are the same as specified for each individual ~~facility~~ [BMP](#), unless noted below. The following combined [BMPs](#) ~~facilities~~ are addressed in this section:

- [BMP D.1: Detention Ponds / BMP T10.10: Wetponds - Basic and Large](#)
- [BMP D.3: Detention Vaults / BMP T10.20: Wetvaults](#)
- [BMP D.1: Detention Ponds / BMP T10.30: Stormwater Treatment Wetlands](#)
- ~~• [Detention/wetpond \(basic and large\)](#)~~
- ~~• [Detention/wetvault](#)~~
- ~~• [Detention/stormwater wetland](#)~~

There are two sizes of the combined wetpond, a basic and a large, but only a basic size for the combined wetvault and combined stormwater wetland. The [facilityBMP](#) sizes (basic and large) are related to the treatment performance goals ([refer to see](#) Volume I, Section 4.2.6).

5.4.29.2 Performance Mechanism

The intent of a combined detention and wetpool [BMPfacility](#) is to provide [runoffwater quality](#) treatment in addition to flow control. The three types of combined facilities provide [runoffwater quality](#) treatment as follows:

- A combined detention [pond](#)/wetpond provides pollutant removal via settling and biological uptake.
- A combined detention/wetvault provides pollutant removal via settling.
- A combined detention/stormwater wetland provides pollutant removal via settling, biological uptake, filtration, and soil adsorption.

5.4.29.3 Application and Limitations

Combined detention and [runoff treatment BMPswater quality facilities](#) can be efficient for sites that also have detention requirements, but for which infiltration is infeasible ([Volume II, Section 5.3.2](#)). The [runoff treatment BMPwater quality facility](#) may often be placed beneath the detention [facilityBMP](#) without increasing the [facilityBMP](#) surface area. However, the fluctuating water surface of the live storage will create unique challenges for plant growth and for aesthetics alike.

The basis for pollutant removal in combined facilities is the same as in the stand-alone [runoff treatment BMPswater quality facilities](#). However, in the combined [facilityBMP](#), the detention function creates fluctuating water levels and added turbulence. For simplicity, the positive effect of the extra live storage volume and the negative effect of increased turbulence are assumed to balance, and are thus ignored when sizing the wetpool volume. For the combined detention/stormwater wetland, criteria that limit the extent of water level fluctuation are specified to better ensure survival of the wetland plants.

[Unlike the wetpool volume, the live storage component of the combined detention and wetpool BMP shall be provided above the seasonal high water table.](#)

Combined detention and wetpool [BMPsfacilities](#) can be applied to [partially or fully satisfy runoff treatment and flow control requirements as shown in Table 5.32.](#)~~meet the requirements as summarized below.~~

Table 5.32. Combined Detention and Wetpool BMP Facilities Applicability

BMP	MR #5: On-site Stormwater Management		MR #6: Runoff Treatment				MR #7: Flow Control
	List	LID Performance Standard	Basic	Enhanced	Oil Control	Phosphorous	
Combined detention and wetpond			X	X ^a		X ^b	X
Combined detention and wetvault			X	X ^a		X ^b	X
Combined detention and stormwater wetland			X	X ^a		X ^b	X

Notes:

- a Can be used to meet enhanced runoff treatment requirement as part of a two-facilityBMP treatment train; refer to see [Volume III, Chapter 1 in the Ecology Manual](#).
- b Can be used to meet phosphorus runoff treatment requirement as part of a two-facilityBMP treatment train; refer to see [Volume III, Chapter 1 in the Ecology Manual](#).

5.4.29.4 Site Considerations

Refer to See [Volume V, Chapter 8, BMP T10.40 in the Ecology Manual](#) for site considerations. Also see the setback requirements for detention ponds ([Volume II, Section 5.4.26](#)), wetponds ([Volume II, Section 5.4.22](#)), wetvaults ([Volume II, Section 5.4.23](#)), and/or stormwater treatment wetlands ([Volume II, Section 5.4.24](#)), depending on the combined detention and wetpool facilityBMP type.

5.4.29.5 Design Information

Refer to See [Volume V, Chapter 8, BMP T10.40 in the Ecology Manual](#) for detailed design guidance and criteria on combined detention and wetpool facilitiesBMPs.

5.4.29.6 Minimum Construction Requirements

Construction requirements are the same as for wetponds ([Volume II, Section 5.4.22.6](#)), wetvaults ([Volume II, Section 5.4.23.6](#)), or stormwater treatment wetlands ([Volume II, Section 5.4.24.6](#)), depending on the combined detention and wetpool facilityBMP type.

5.4.29.7 Operations and Maintenance

Refer to [operations and maintenance for detention and wetpool BMPs \(See Volume II, Section 5.4.22 and 5.4.26\) Volume V of the Ecology Manual](#) for required maintenance practices for combined detention and wetpool facilitiesBMPs.

5.4.30 Emerging Technologies Manufactured Treatment Devices as BMPs

5.4.30.1 BMP Description

To receive Ecology approval for use in stormwater applications in Washington, new technologies shall be evaluated following [Ecology's technology assessment protocols](#) (TAPE and CTAPE), which establish guidelines for evaluating the performance of ~~runoffwater quality~~ treatment technologies in achieving different levels of performance (i.e., pretreatment, basic, enhanced, phosphorus, oil). The evaluation process requires manufacturers to field test the performance of new ~~runoffwater quality~~ treatment technologies. After the successful completion of field testing, the vendor submits a technology evaluation report (TER) to Ecology for review and approval. Information about Ecology's evaluation process can be found on [Ecology's TAPE web page](#).

Under the technology assessment process, Ecology assigns "Use Level Designations" to ~~assess levels of development for emerging technologies manufactured treatment devices and BMPs based on the results of the TAPE and CTAPE evaluation. The use level designations established by Ecology are Ecology establishes the use level for each technology and its associated performance level based on the quantity, relevance, amount, and quality, and type of performance data available as defined below (Seattle 2016): There are three use level designations:~~

- GULD – General Use Level Designation: A General Use Level Designation (GULD) is assigned to technologies for which the performance monitoring demonstrates with a sufficient degree of confidence, that the technology is expected to achieve Ecology's performance goals. Use is subject to conditions, including design restrictions and sizing, documented in a use level designation letter prepared by Ecology.
- CULD – Conditional Use Level Designation: A Conditional Use Level Designation (CULD) is assigned to technologies that have considerable performance data not collected per the TAPE protocol. Ecology will allow the use of technologies that receive a CULD for a specified time, during which performance monitoring shall be conducted and a TER submitted to Ecology. Units that are in place do not have to be removed after the specified time period. Use is subject to conditions, including design restrictions and sizing, documented in a use level designation letter prepared by Ecology.
- PULD – Pilot Use Level Designation: A Pilot Use Level Designation (PULD) is assigned to new technologies that have limited performance monitoring data or that only have laboratory performance data. The PULD allows limited use of the technology to allow performance monitoring to be conducted. PULD technologies may be installed provided that the vendor and/or developer agree to conduct performance monitoring per the TAPE protocol at all installations. Use is subject to conditions, including design restrictions and sizing, documented in a use level designation letter prepared by Ecology.

5.4.30.2 Performance Mechanism

Ecology has established different performance goals for [runoffwater quality](#) treatment technologies based on the types of pollutants that they are effective in removing and their applicable use for [runoffwater quality](#) treatment. Proprietary technologies use a wide variety of mechanisms to achieve these performance goals. ~~This section has further information on a small sub-set of proprietary technologies that have achieved a GULD designation using primarily filtration and adsorption.~~

5.4.30.3 Application and Limitations

There are various Ecology-approved proprietary technologies that can satisfy runoff treatment requirements for pretreatment, oil control, phosphorus control, basic treatment, and enhanced treatment. Refer to [Ecology's TAPE web page](#) for a list of approved technologies.

5.4.30.4 Site Considerations

Site considerations are dependent on the approved technology selected; ~~refer to~~ [Ecology's TAPE web page](#) and specific manufacturer recommendations.

5.4.30.5 Design Information

Design information and guidance for each specific approved technology is included on [Ecology's TAPE web page](#).

5.4.30.6 Minimum Construction Requirements

See the below requirements and ~~requirements those~~ provided on [Ecology's TAPE web page](#) for minimum construction requirements for [emerging technologies manufactured treatment devices and BMPs](#):

- Follow the manufacturer's recommended construction procedures and installation instructions as well as any applicable Kitsap County requirements.
- Follow the manufacturer's requirements for flow rate restrictions.
- Protect media filter systems from construction flows. Thoroughly clean structures and replace media or media cartridges if impacted from construction flows.

5.4.30.7 Operations and Maintenance

Refer to [Ecology's TAPE web page](#) and the manufacturer's website for [facilityBMP](#)-specific maintenance requirements.

CHAPTER 6 WETLANDS PROTECTION

6.1 Introduction

This chapter describes the requirements for meeting Minimum Requirement #8—[Wetlands Protection](#). See Volume I, Section 4.2.8 for a description of this minimum requirement.

6.2 Applicability

The requirements below apply only to projects with stormwater discharges into a wetland, either directly or indirectly through a conveyance system. These requirements, where applicable, must be met in addition to meeting Minimum Requirement #6 —[Runoff Treatment](#) and Minimum Requirement #7—[Flow Control](#).

6.3 Thresholds

The thresholds identified in Minimum Requirement #6 —[Runoff Treatment](#) and Minimum Requirement #7—[Flow Control](#) shall also be applied to determine the applicability of these requirements to discharges to wetlands. If the project discharges stormwater runoff to a stream that leads to a wetland, or to a wetland that has an outflow to a stream, Minimum Requirement #8 applies.

6.4 Standard Requirement

In addition to meeting requirements for [runoffwater-quality](#) treatment and flow control (Minimum Requirements #6 and 7, respectively), discharges to wetlands shall maintain the hydrologic conditions, hydrophytic vegetation, and substrate characteristics necessary to support existing and designated uses. Projects shall comply with [Volume I, Appendix I-C of the Ecology Manual](#). The hydrologic analysis shall use the existing land conditions⁶ to determine the existing hydrologic conditions unless directed otherwise in the Critical Areas Ordinance codified as [Title 19 KCC](#).

6.5 Coordination with Minimum Requirement #7

In most cases, if wetland hydroperiod protection is required per MR #8, then the flow control performance standard is also required per MR #7 (see Volume I, Section 4.2.7). In these cases, the designer must attempt to meet the requirements for both minimum requirements. This may prove to be infeasible in some situations because MR #7 will seek to adjust the flow in small time intervals and MR #8 looks to maintain daily flow volumes.

If the designer is unable to meet both requirements, then the requirement to maintain the hydroperiod of the wetland becomes the overriding concern and the designer must show

⁶ For the purpose of applying this threshold, the existing land condition is either the pre-project land cover, (for a developed site with an approved stormwater mitigation plan) or the land cover that existed at the site as of a date when [the Kitsap](#) County first adopted flow control requirements into code or rules (September 21, 1987).

compliance with MR #8. If this is the case, the designer must also provide documentation detailing why they are unable to meet both requirements, and is subject to director approval.

CHAPTER 7 OPERATION AND MAINTENANCE

7.1 Introduction

For stormwater ~~flow control and treatment~~~~quantity and quality control~~ best management practices (BMPs) facilities to achieve their intended results, proper operation and maintenance (O&M) are essential. This chapter defines O&M requirements and details the contents of the O&M Manual, which shall be submitted to the County as an appendix to the project Drainage Report per Volume II, Chapter 1 ~~of this manual~~.

7.2 Operation and Maintenance Requirements

This section outlines the maintenance responsibilities, activities and frequencies; regulations for disposal of waste resulting from maintenance activities; and requirements for maintenance of plat BMPs facilities during home building.

7.2.1 Responsibility for Maintenance

Property owners are responsible for the maintenance, operation, or repair of stormwater drainage systems and BMPs, including conveyance, On-Site Stormwater Management, Flow Control, and ~~Water Quality~~ Treatment BMPs. Property owners shall maintain, operate, and repair these BMPs facilities in compliance with the requirements of Title 12 KCC and with the requirements of this manual.

7.2.2 Maintenance Activities and Frequencies

Required maintenance activities, including inspection and maintenance frequencies, are provided in the following reference documents:

- *Stormwater Management Manual for Western Washington* (Ecology Manual) by the Washington State Department of Ecology Water Quality Program, July 2019~~amended December 2014~~.
- *Western Washington Low Impact Development (LID) Operations and Maintenance (O&M)*, by the Washington State Department of Ecology Water Quality Program, May 2013.
- Kitsap Low Impact Development Guidance Manual Appendix C checklists (Kitsap Home Builders Foundation 2009)~~Clean Water Kitsap Plant List~~, which is a living document that ~~is managed and maintained on the County's website~~.

Stormwater BMPs facilities shall be inspected and maintained routinely and cleared of debris, sediment, and vegetation when the functioning and/or design capacity of the BMP facility is affected. Where lack of maintenance is causing or contributing to a water quality problem, immediate action shall be taken to correct the problem.

7.2.3 Disposal of Waste from Maintenance Activities

Disposal of waste from stormwater maintenance activities shall be conducted in accordance with Kitsap County Board of Health Ordinance 2004-2, Solid Waste Regulations, [as now or hereafter amended](#), that adopts the Solid Waste Handling Standards in [Chapter 173-350 WAC](#) and where appropriate, the Dangerous Waste Regulations, [Chapter 173-303 WAC](#).

7.2.4 Maintenance of Plat ~~BMPs~~Facilities During Home Building

The responsibility for maintenance of a residential plat ~~is outlined in~~ rests with the entity that ~~bonded the plat for maintenance in accordance with~~ [KCC Section 12.12.060](#) (for publicly maintained plats) and in [KCC Section 12.24.020](#) (for privately maintained plats). ~~The~~ ~~This~~ ~~responsible~~ party shall ~~be responsible for~~ maintaining the stormwater ~~BMPs~~management facilities as required by this manual. These ~~BMPs~~facilities shall be inspected by Kitsap County at least once every 6 months during home construction to ensure maintenance is conducted during the 2-year bonding period.

7.3 Operation and Maintenance Manual

An O&M Manual shall be submitted to the County as an appendix to the Drainage Report (Volume II, Section 1.4.4 ~~of this manual~~). The O&M Manual shall provide O&M standards and guidelines for all proposed stormwater conveyance, On-Site Stormwater Management, Flow Control, and ~~Water Quality~~Treatment BMPs that are to be privately maintained. The O&M Manual shall be prepared by a professional engineer ~~and should be simply written~~ using plain language so it can be effectively followed by those persons who will be responsible for operating and maintaining the ~~facilities~~BMPs.

The following basic outline shall be followed in the preparation of the O&M Manual:

A. General Information:

1. Purpose of O&M Manual – Briefly provide an introduction to the manual and a general statement on the overall purpose of operation and maintenance for each ~~BMP~~facility.
2. Basis of O&M Requirements – Identify the standards that were used to develop the O&M requirements. Incorporate [information from](#) the ~~above-listed~~ reference documents in [Volume II](#), Section 7.2.2, as appropriate, and include any other reference documents that were used.
3. Location and Access to ~~BMP~~Facility – Include the following:
 - a. Name of stream/tributary/lake, etc., that ~~BMP~~facility discharges to.
 - b. Nearest cross streets.
 - c. Traveling directions to ~~BMP~~facility, including location of maintenance access roads.
 - d. Vicinity map.

4. Purpose of BMPsFacilities and Primary Performance Mechanisms – Document the primary purpose of BMPsfacilities and the key mechanisms for performing the primary purpose (e.g., conveyance for safe transport of stormwater runoff, peak flow rate reduction for flow control, infiltration for onsite stormwater management, filtration for water quality treatment, sedimentation for water quality treatment, etc.).
5. General Description of BMPsFacilities – Describe BMPfacility types (e.g., conveyance pipes, conveyance structures, bioretention swales, permeable pavement, etc.).
6. Ownership – Include name, address, and telephone number of BMP owner-of facility.
7. Project History – Identify the development for which BMPfacility was constructed, date of construction, original project engineer and contractor, any significant modifications that have taken place during the life of the BMPfacility.
8. Project Data Sheet – List all major features of the BMPfacility in an easy-to-follow tabular format, including catchment area, contributing hard surface area, offsite tributary drainage area, storage volume, design infiltration rates, orifice sizes, and designed release rates.

B. Facility BMP Operation and Maintenance Plan:

The BMPFacility O&M Plan provides detailed procedures required for routine and emergency O&M for all proposed stormwater facilities-BMPs (i.e., conveyance, On-Site Stormwater Management, Flow Control, and Water Quality Treatment BMPs). This plan shall address the following components:

1. Emergency Action Plan – Describe special operating procedures to be followed during emergency conditions, such as those resulting from extreme weather conditions or from structural or operational failure of the BMPfacility. 24-hour emergency contact telephone numbers must be included.
2. Routine Maintenance – Identify maintenance tasks that shall be performed on a routine, regular basis. Describe the specific tasks and subtasks, staff and equipment needed, and frequencies for all maintenance activities.
3. Triggered Maintenance – Identify maintenance activities that shall be conducted as-needed based on specified conditions or events, such as during or after storm events, flooding or water quality issues, or issues noted by staff during routine or triggered inspections. Specify the types of conditions that trigger the need for these maintenance activities and the specific tasks and subtasks, staff and equipment needed, and frequencies for all maintenance activities.

C. BMPFacility Inspection Plan:

This section provides inspection checklists and an inspection report form to address the following components:

1. Inspection Checklists – Include inspection checklists for all proposed stormwater facility BMP types, addressing:

- a. *Routine Inspections* – Identify routine visual inspection activities for the major features of the stormwater [BMPsfacilities](#) (i.e., inlets, outlets, infiltration areas, ponding areas, vegetated areas, etc.). Specify the staff and equipment needs and frequencies for all activities (e.g., weekly, monthly, etc.).
 - e. *Triggered Inspections* – Identify inspection activities that shall be conducted on an as-needed basis, such as during or after storm events, to assess resident or business drainage complaints, or address staff observations during routine inspections. Specify the types of conditions or events that trigger the need for these inspections and the specific tasks or subtasks and staff and equipment needed.
2. Inspection Report Form – Include a simple form to be completed by the person(s) performing the inspection that includes the date of inspection, the name of the person(s) performing the inspection, specific findings, follow-up actions needed, and the inspection checklist.

CHAPTER 8 CRITICAL DRAINAGE AREAS

8.1 Introduction

Critical drainage areas are defined by specific site attributes, separate ordinances, the regulatory actions of other governmental entities, Kitsap County Public Works, special studies, or the director. [Chapter 12.28 KCC](#) provides a listing of the general critical drainage area designations.

All developments located within critical drainage areas shall conduct a Level 1 Downstream Analysis, in accordance with Volume II, Chapter 4. The remainder of this chapter provides supplemental requirements and guidance for analysis and mitigation of stormwater quantity and/or quality impacts to critical drainage areas.

8.2 Identification of Critical Drainage Areas

[KCC Section 12.28.020](#) provides that critical drainage areas include “any lands determined by the director to have a high potential for drainage and water quality problems, and/or are sensitive to the effects of construction or development.”

Sometimes, the critical nature of these drainage areas only becomes apparent once some degree of development is planned or has already occurred. In some subdivisions constructed prior to modern stormwater codes, for example, development of infill lots is often severely constrained by the unplanned and piecemeal drainage controls installed over time by individual lot owners. Kitsap County may, therefore, evaluate areas proposed for designation as critical drainage areas and conduct such studies, as necessary, to make such designations.

The areas defined as critical drainage areas in [KCC Section 12.28.020](#) are divided into three general categories. Each of these critical drainage area categories is discussed in further detail [below in the following sections](#):

- Areas with specific physical site attributes- [\(Volume II, Section 8.2.1\)](#)
- Areas defined for protection of fish and wildlife, and/or surface water quality- [\(Volume II, Section 8.2.2\)](#)
- Areas designated as having documented and/or potential drainage problems- [\(Volume II, Section 8.2.3\)](#)

8.2.1 Areas with Specific Site Physical Attributes

The Critical Areas Ordinance (CAO) ([Title 19 KCC](#)) defines critical areas based on site physical attributes, such as:

- Slopes greater than or equal to 30%;
- Geologically hazardous areas and historically documented unstable slopes;

- All lands that are classified as wetlands as defined by any separate Kitsap County ordinance or policy (~~see refer to~~ [Volume II, Chapter 6—Wetlands Protection](#)); or
- Lands that have existing local requirements for the management or protection of streams, shorelines, critical fish and wildlife habitat, groundwater, aquifers, or sole source aquifers.

The CAO provides a variety of measures to protect these areas, including buffer zones, construction setbacks, and requirements for additional study as needed. In many cases, special attention to post-development stormwater impacts and controls are required. The typical drainage measures that may be required are provided in [Volume II, Section 8.3](#) below. A [Site Development Activity Permit \(SDAP\)](#) may be required under the conditions specified in [Title 12 KCC](#).

8.2.2 Areas Defined for Protection of Fish & Wildlife Habitat and Surface Water Quality

Federal and state law require watershed scale practices to protect fish and wildlife habitat and surface water quality for the following areas:

- Lands within 200 feet of ordinary high water marks for water bodies with fish spawning and rearing habitat for anadromous and resident fish species, as designated by the [Washington](#) State Department of Fish and Wildlife;
- Lands that have existing local or state requirements for the protection of particular fish or wildlife habitats; or
- Lands that are established by law as shellfish protection areas.

8.2.3 Areas Designated as Having Documented and/or Potential Drainage Issues

Kitsap County has identified specific problem drainage areas that require additional attention in the design, permitting and construction for land development. Sixteen areas have been ~~so~~ identified within Kitsap County (Figures 8.1, 8.2, and 8.3). The designation of an area is typically based on problems associated with the conveyance of [stormwatersurface](#) runoff and/or downstream capacity limitations, including closed depressions.

In many of the defined areas, conveyance and downstream problems stem from the long-ago creation of large concentrations of small lots with no consideration given to topography and drainage when the lots were created. Two of these areas (Suquamish and Manchester) have site development criteria and restrictions defined in the Zoning Code ([Title 17 KCC](#)). These restrictions provide upper limits on the percentage of impervious cover and conditions for engineered drainage plans ([Chapters 17.360D, 17.360B](#) and [17.420 KCC](#)). Keyport Rural Village also has impervious cover limitations, as specified in [Chapters 17.360A](#) and [17.420 KCC](#). Further development in these areas is often complicated by the absence of conveyance routes for stormwater discharges, and poor soils and/or limited area for infiltration.

8.3 Supplemental Requirements

[KCC Section 12.28.010](#) allows the director to require drainage improvements in excess of those required in other sections of [Title 12 KCC](#) in order to mitigate or eliminate potential drainage-related impacts within critical drainage areas. For particularly sensitive drainage areas, the director may specify the type of drainage analyses and mitigation required.

(See separate file for Public Review Draft figures)

[Figure 8.1](#) **Critical Drainage Areas Commissioner District 1**

[Figure 8.2](#) **Critical Drainage Areas Commissioner District 2**

[Figure 8.3](#) **Critical Drainage Areas Commissioner District 3**

Drainage areas defined as critical often have more than one characteristic feature (e.g., steep unstable slopes along a shoreline or flanking a stream). The major stormwater management objective in nearly all cases is to mimic as closely as possible the natural (pre-development) hydrologic conditions to protect both environmental receptors and human life and property.

Development within critical drainage areas requires the appropriate specialist within the specific field to provide recommendations and design for mitigation. In slope or stability-related critical areas, a qualified geotechnical consultant shall make specific drainage mitigation recommendations. Where required, a professional engineer shall incorporate the recommendations into the stormwater management designs.

In wetlands, streams and shoreline critical areas, a qualified habitat biologist shall make specific mitigation recommendations. Where required, a professional engineer shall incorporate the recommendations into the stormwater management designs.

8.3.1 Closed Depressions

The analysis of closed depressions requires careful assessment of the existing hydrologic performance in order to evaluate the impacts a proposed project will have.

Closed depressions generally facilitate infiltration of runoff.

If a closed depression is classified as a wetland, then Minimum Requirement #8 ~~Wetlands Protection~~ applies. ~~If there is an outflow from this wetland, then the flow from this wetland must also meet the Minimum Requirement #7—Flow Control.~~ [Review Volume I, Section 4.2 to determine which other Minimum Requirements apply to the site.](#)

An [Ecology](#) approved continuous simulation hydrologic model must be used for closed depression analysis and design of mitigation facilities. [If a closed depression is not classified as a wetland, model the ponding area at the bottom of the closed depression as an infiltration pond using an approved continuous simulation hydrologic model.](#)

Infiltration shall be addressed where appropriate. Refer to Volume [I](#), Chapter 2 for site planning of infiltration facilities and Volume II, Chapter 5 for design of infiltration BMPs.

If a proposed project will discharge runoff to an existing closed depression, the following requirements must be met:

- **Case 1** – For closed depressions located entirely on site, and where no runoff occurs in the pre-developed condition, no runoff may leave the site in the developed condition. If the modeling indicates the facility will overflow in the developed condition, the closed depression may be modified to provide the required storage, or may be modeled as a combination infiltration/detention facility with control structure and emergency overflow weir, access road, etc., in accordance with Volume II, Chapter 5—[BMP Design](#). The required performance shall meet the flow duration frequency standards per Minimum Requirement #7—[Flow Control](#). To determine whether runoff occurs in the pre-developed condition, the pre-development runoff time series from the drainage basin tributary to the onsite closed depression shall be routed to the closed depression using only infiltration as outflow.
- **Case 2** – For closed depressions located entirely on site, where runoff occurs in the pre-developed condition, the closed depression shall then be analyzed as a detention/infiltration pond. The flow duration frequency standards per Minimum Requirement #7—[Flow Control](#) shall be met.
- **Case 3** – If the closed depression is located partially or completely off site, impacts to adjacent properties shall be evaluated and appropriate mitigation provided including any downstream easements. If offsite easements can be obtained, the closed depression may be modified to meet the required performance standard as in Case 1, [above](#). If offsite easements cannot be obtained, then the total volume of runoff discharged from the project site may not be increased above the total pre-development runoff volume.

8.3.2 Steep Slopes and Geologically Hazardous Areas

Stormwater management designs for projects within these critical areas shall comply with recommendations of geotechnical analysis required under [Chapter 19.400 KCC](#). The geotechnical engineer shall evaluate the minimum criteria applicable to the project and make drainage recommendations. The project engineer shall incorporate the design recommendations into the design.

Proposed measures may include, but are not limited to, additional setbacks from the top of slope for infiltration facilities, outright prohibition of infiltration, collection and conveyance of surface runoff to minimize uncontrolled flow over the top of slope, preservation of existing native vegetation, or re-vegetation of cleared areas.

8.3.3 Aquifer Recharge Areas

Projects that fall within aquifer recharge areas shall comply with the requirements of [Chapter 19.600 KCC](#). Where a hydrogeologic study is required, the study shall address, at a minimum, all the criteria listed in [Chapter 19.700 KCC](#). Aquifer recharge areas are provided on [Kitsap County's Community Development Maps/GIS web page](#).

8.3.4 Wetlands and Streams

Buffer zones are identified in the CAO for each wetland type and stream type. A construction setback from the buffer is also required. Encroachment on these mandatory buffers or setbacks can trigger the requirement for an SDAP. Wetland buffer requirements are provided in [Chapter 19.200 KCC](#), and stream buffer requirements are provided in [Chapter 19.300 KCC](#). Additional stormwater control requirements for development in proximity to wetlands are addressed in Volume II, Chapter 6.

8.3.5 Shorelines

The shorelines of Puget Sound exhibit a variety of landforms, ranging from relatively level to very steep high bluffs. With respect to stormwater management, erosion and sediment control, stormwater conveyance, and energy dissipation are of primary concern for maintenance of slope stability and habitat preservation. Refer to [Title 22 KCC](#) and [Chapter 19.300 KCC](#) for development standards that may apply.

This page intentionally left blank.

CHAPTER 9 GRADING

9.1 Introduction

This chapter describes the requirements for compliance with [Chapter 12.16 KCC](#). For application submittal requirements and information about the submittal process, refer to Volume II, Chapter 1. Minimizing grading impacts is also a key component to proper, upfront site planning and analysis; refer to Volume I, Chapter 2 for a detailed discussion on this topic.

9.2 Review Coordination

When grading activities are proposed for a site and such activities are related to a project requiring land use approval from Kitsap County, a [Site Development Activity Permit \(SDAP\)](#) for the proposed grading activity will not be issued by Kitsap County until all land use permits and/or approvals are granted.

Conditions imposed by the Board of Commissioners, [the Department of Community Development \(DCD\)](#), the Kitsap County Hearing Examiner, or other governmental agencies affecting the SDAP for grading must be incorporated into the project's design and must be implemented prior to final approval of the project.

When development is intended or proposed on a site affected by issuance of a SDAP for grading ([KCC Section 12.10.030](#)), work allowed by issuance of that permit shall be subordinate to future site development conditions or requirements.

When grading on a parcel of land is proposed which is intended to facilitate the future development of a site, or which may limit the future use of the site, ~~the Kitsap County~~ may require that a notice be recorded as a public record containing provisions which will include the nature and extent of the grading which has occurred on the parcel. ~~The latest version of the form entitled "Notice of Grading or Filling" shall be used; see Appendix I for a copy of the form.~~

9.3 Permit Requirements

All SDAPs for grading shall be submitted in accordance with [Chapter 12.16 KCC](#) and the requirements of Volume II, Chapter 1.

9.3.1 Construction Limits

Prior to the commencement of permitted clearing and grading activities, clearing and grading limits shall be clearly and visibly identified using staking and/or flagging. Under no circumstances may areas beyond the property boundaries be disturbed without the prior approval of the owners of those properties and without the issuance of all necessary permits by Kitsap County to work within these areas. Clearing limits may require inspection by DCD prior to commencement of site work activities.

Clearing limits shall include delineation/fencing of tree root protection zones. Refer to Volume I, Chapter 2 for detailed discussion on site analysis and planning to protect existing trees and

Volume II, Chapter 1 for Construction [Stormwater Pollution Prevention Plan \(SWPPP\)](#) requirements.

9.3.2 Engineers' Notification Of Noncompliance

If, in the course of fulfilling [his/her/their](#) responsibility under [Title 12 KCC](#), the project civil engineer or any associated engineer finds the work is not being done in conformance with [Chapter 12.16 KCC](#) and this chapter or with the conditions of permit approval or the approved site improvement plan (see submittal requirements in Volume II, Chapter 1), the discrepancies shall be reported immediately in writing to the [responsible party/person](#) in charge of the grading work and to the director. Recommendations for corrective measures, if necessary, shall be submitted.

9.3.3 Inspections

DCD shall be called for minimum inspection as follows and additional inspections may be required:

3. After erosion and sedimentation control [best management practices \(BMPs\)facilities](#) are in place and prior to the commencement of grading operations.
4. After rough grading is completed.
5. For final inspection, following site stabilization.

9.3.4 Completion of Work and Final Approval

Final approval of work and the release of performance bonds shall not take place until the following has been completed:

1. All work, including installation of all drainage [BMPsfacilities](#) and their protective devices, and all erosion control measures, including permanent stabilization, have been completed in accordance with the final approved Grading Plan and the approved Construction SWPPP.
2. Final inspection and approval of work by [the-Kitsap](#) County.
3. Any required final reports and statements of approval from the project engineer have been submitted to and approved by [the-Kitsap](#) County.
4. Any required easements related to operation and maintenance of drainage [BMPsfacilities](#) have been recorded.

9.4 Grading Standards

The grading standards [provided belowdescribed in this section](#) are intended as minimum requirements for grading in Kitsap County. If circumstances create a hazard to life, endanger or adversely affect the use or stability of a public way, adjacent property, critical area, or drainage course, [the-Kitsap](#) County may impose additional or more stringent requirements to fulfill the intent of the [Title 12 KCC](#).

9.4.1 Geotechnical Report

When a geotechnical analysis is required by [KCC Section 12.10.080](#) or by BMP design requirements in Volume II, Chapter 5, a Geotechnical Report shall be submitted in accordance with the requirements of Volume II, Chapter 1.

9.4.2 Excavations

Unless otherwise recommended in an approved geotechnical report, all excavations must comply with the following minimum requirement:

1. Excavated slope faces shall be no steeper than is safe for the intended use and shall not be steeper than 2 horizontal to 1 vertical (2H:1V).

9.4.3 Fills and Embankments

Unless otherwise recommended in an approved geotechnical report, all fills and embankments shall comply with the following minimum requirements.

1. Preparation of Ground – Fill slopes shall not be constructed on natural slopes steeper than 2H:1V. The ground surface shall be prepared to receive fill by removing vegetation, noncomplying fill, topsoil and other unsuitable materials, scarifying the surface to provide a bond with the new fill and, where natural slopes are steeper than 3H:1V and the height is greater than 5 feet, by benching into sound bedrock, glacial till or other competent material as determined by a [geotechnical soils](#) engineer. The bench under the toe of fill on a slope steeper than 3H:1V shall be at least 10 feet wide. The area beyond the toe of fill shall be sloped for sheet overflow or a paved drain shall be provided. When fill steeper than 3H:1V and higher than 5 feet is to be placed over an excavation, the [soils engineer and/or](#) geotechnical engineer shall certify that the foundation is suitable for the fill.

2. Fill Material – Detrimental amounts of organic material shall not be permitted in fills. Except as permitted by the director, no rock or similar irreducible material with a maximum dimension greater than 12 inches shall be buried or placed in fills.

Exception: The director may permit placement of larger rock or similar irreducible material (i.e., concrete, etc.) when a geotechnical engineer properly devises a method of placement and continuously inspects its placement and approves the fill stability. The following conditions shall also apply:

- a. Prior to issuance of a SDAP for grading, potential rock disposal areas shall be delineated on the grading plan.
 - b. Rock sizes greater than 12 inches in maximum dimension shall be 10 feet or more below grade, measured vertically.
 - c. Rocks shall be placed so as to ensure filling of all voids with well-graded soil.
3. Compaction – All fills and embankments shall be compacted to a minimum of 90% of maximum dry density, as determined by the tests described in the [WSDOT/APWA Standard Specifications for Road, Bridge, and Municipal Construction](#). Embankments

constructed as berms for the holding back of water shall be compacted to a minimum of 95% of maximum dry density. Soil density shall be determined utilizing the Modified Proctor method. Fills on sites of proposed structures shall be compacted as directed by the Kitsap County Building Official in accordance with the International Building Code (I.B.C). Where the director requires testing of the compaction of soils outside public ~~right-of-way~~right of way, compaction shall be tested by an independent soils testing lab at the owner's expense.

4. Slope – The slope of fill surfaces shall be no steeper than is safe for the intended use and shall be no steeper than 2H:1V.
5. Structures – Fills which are intended to support structures shall be constructed in conformance with the requirements of the latest edition of the I.B.C., and an assignment of allowable soil-bearing pressures will be under the jurisdiction of the Kitsap County Building Official in accordance with the I.B.C. When fill is proposed over an area that the County deems to be a potential building site, and the applicant does not state an intent to construct buildings on the fill area, ~~the Kitsap~~ County may at its own discretion require that a notice be recorded as a public record containing provisions which will include the nature and extent of the grading which has occurred on the parcel. ~~The latest version of the form entitled "Notice of Grading or Filling" shall be used; see Appendix I for a copy of the form.~~

9.4.4 Setbacks

1. General – Excavation and fill slopes shall be set back from site boundaries in accordance with this section. Setback dimensions shall be horizontal distances measured perpendicular to the site boundary.
2. Top of Cut Slopes – The top of cut slopes shall not be made nearer to a site boundary line than one-fifth of the vertical height of cut with a minimum of 2 feet and a maximum of 10 feet. The setback may need to be increased for any required interceptor drains.
3. Toe of Fill Slopes – The toe of fill slopes shall be made not nearer to the site boundary line than one-half the height of the slope with a minimum of 5 feet and a maximum of 20 feet. Where a fill slope is to be located near the site boundary and the adjacent offsite property is developed, special precautions shall be incorporated in the work as the director deems necessary to protect the adjoining property from damage as a result of such grading. These precautions may include but are not limited to:
 - a. Additional setbacks.
 - b. Provision for retaining or slough walls.
 - c. Mechanical or chemical treatment of the fill slope surface to minimize erosion.
 - d. Provisions for the control of surface waters.
4. Modification of Slope Location – The director may approve or require alternate setbacks and may require an investigation and recommendation by a qualified engineer to demonstrate that the intent of this section has been satisfied.

9.4.5 Drainage and Terracing

1. General – Unless otherwise indicated on the approved grading plan, drainage [BMPsfacilities](#) and terracing shall conform to the provisions of this chapter for cut or fill slopes steeper than 3H:1V.
2. Terrace – Terraces at least 6 feet in width shall be established at not more than 30-foot vertical intervals on all cut or fill slopes to control surface drainage and sloughing. Where only one terrace is required, it shall be at approximately mid-height. For 3:1 or steeper cut or fill slopes greater than 60 feet and up to 120 feet in vertical height, one of the required terraces shall be located at approximately mid-height and shall be 12 feet in width.

Example:

- a. A vertical slope of 36-foot height is proposed. A minimum of one terrace, at least 6 feet in width, shall be provided at approximately 18-foot vertical height.
 - b. A vertical slope of 75 feet is proposed. One terrace, 12 feet in width, shall be provided at approximately 37.5-foot vertical height. Two additional terraces, each at least 6 feet in width (one higher and one lower) shall be provided so that no vertical height greater than 30 feet is created without a terrace.
 - c. Terrace widths and spacing for cut and fill slopes greater than 120 feet in height shall be designed by a geotechnical engineer and approved by the director. Suitable access shall be provided to permit proper cleaning and maintenance of the terraces.
 - d. A single run of swale or ditch shall not collect runoff from a tributary area exceeding 13,500 square feet (projected) without discharging into a down drain.
3. Subsurface Drainage – Cut and fill slopes shall be provided with subsurface drainage as necessary for stability.
 4. Disposal:
 - a. All drainage [BMPsfacilities](#) shall be designed to carry waters to the nearest practicable drainage [courseway](#) approved by the director or other appropriate jurisdiction as a safe place to deposit such waters. Erosion of ground in the area of discharge shall be prevented by installation of non-erosive down-drains or other devices.
 - b. Building pads shall have a drainage gradient of 2% toward approved drainage [BMPsfacilities](#), unless waived by the director.
 5. Interceptor Drains – Paved interceptor drains shall be installed along the top of all graded slopes where the contributing drainage area uphill from the slope has a drainage path greater than 40 feet measured horizontally. Interceptor drains shall be paved with a minimum of 3 inches of concrete or gunite and reinforced. They shall have a minimum depth of 12 inches and a minimum paved width of 30 inches measured horizontally across the drain. The slope of drain shall be approved by the director.

9.4.6 Erosion Control

An application for a SDAP for grading shall include a Construction SWPPP in accordance with Volume II, Chapter 2—~~Construction Stormwater~~.

1. Applicant's Responsibility – Temporary erosion and sedimentation control ~~BMPs~~ facilities shall be installed prior to any clearing and/or grading taking place. The applicant is responsible at all times for the installation and maintenance of erosion and sedimentation control facilities, as stated under Minimum Requirement #2—~~Construction Stormwater Pollution Prevention~~, Element #12: ~~Manage the Project~~.
 - a. Development projects shall be phased to the maximum degree practicable and shall take into account seasonal work limitations.
 - b. The Permittee must require construction site operators to maintain, and repair as needed, all sediment and erosion control BMPs to ensure continued performance of their intended function.
 - c. The Permittee must require construction site operators to periodically inspect their sites. Site inspections shall be conducted per the requirements of Volume II, Chapter 2 ~~of this manual~~.
 - d. The Permittee must require construction site operators to maintain, update and implement their SWPPP. Permittees shall require construction site operators to modify their SWPPP whenever there is a change in design, construction, operation, or maintenance at the construction site that has, or could have, a significant effect on the discharge of pollutants to waters of the state.
2. Emergency Contact Person – An emergency contact person having the means and the authority to institute emergency erosion and sedimentation control measures shall be available at all times until construction is completed, on a 24-hour-per-day basis. The name, address and 24-hour telephone number(s) for the emergency contact person shall be listed with DCD. In the event that ~~the Kitsap~~ County becomes aware of an emergency condition on the project site and is unable to contact the designated emergency contact person, or deems that the response to the emergency situation is inadequate, ~~the Kitsap~~ County may enter the project site and perform any emergency work deemed necessary to protect life and limb, property, or adjacent public ways, critical areas or drainage courses. The project owner will be required to reimburse ~~the Kitsap~~ County for all related costs incurred by ~~the Kitsap~~ County for such emergency work.
3. Sealing the Surface – At the end of each day's work, the contractor must grade all areas to drain.
4. Revegetation – Unless the approved plan provides otherwise, all cleared areas shall be seeded as soon as possible, or receive some other acceptable surface stabilization treatment in accordance with Volume II, Chapter 2.

Kitsap County Stormwater Design Manual

Appendices

3rd Draft
April 2021

2021 3rd Draft Revisions are highlighted in aqua and green

This page intentionally left blank.

CONTENTS

APPENDIX A: GLOSSARY	A-3
APPENDIX B: STANDARD PLAN NOTES	B-3
Construction Sequence	B-3
Drainage Notes	B-3
Temporary Erosion and Sedimentation Control Maintenance Requirements	B-4
Grading Notes	B-4
General Notes	B-4
Inspection Schedule	B-5
General Erosion and Sedimentation Control Notes	B-6
Minimum Erosion and Sedimentation Control Requirements	B-7
APPENDIX C: SITE ASSESSMENT AND PLANNING PACKET	C-3
APPENDIX D: DETERMINING CONSTRUCTION SITE SEDIMENT DAMAGE POTENTIAL	D-3
Step 1 – Sediment/Erosion Sensitive Feature Identification	D-3
Step 2 – Hydraulic Nearness Assessment	D-3
Step 3 – Construction Site Sediment Transport Potential	D-4
APPENDIX E: CONSTRUCTION SITE SEDIMENT TRANSPORT POTENTIAL WORKSHEET	E-3
APPENDIX F: HYDROLOGIC/HYDRAULIC MODELING METHODS	F-3
F.1 Design Flow Rate	F-3
F.2 Conveyance Capacity	F-4
F.2.1 Pipe Conveyance Systems	F-4
F.2.2 Culverts	F-7
F.2.3 Open Channels	F-14
F.3 Riprap Design Standards	F-19
F.3.1 Riprap	F-19
F.3.2 Riprap Filter Systems	F-19
APPENDIX G: SUBSURFACE INVESTIGATION AND INFILTRATION TESTING FOR INFILTRATION BMPS	G-3
G.1 Roles and Responsibilities of Licensed Professionals	G-3
G.2 Subsurface Investigation	G-3
G.2.1 Description	G-3
G.2.2 General Subsurface Investigation Requirements	G-3
G.2.3 Simple Subsurface Investigation	G-5
G.2.4 Standard Subsurface Investigation	G-5

G.2.5	Comprehensive Subsurface Investigation	G-8
G.2.6	Deep Infiltration Subsurface Investigation	G-8
G.3	Determining the Measured (Initial) K_{sat}	G-9
G.3.1	Description	G-9
G.3.2	Simple Infiltration Test (SIT)	G-10
G.3.3	Small Pilot Infiltration Test (Small PIT)	G-11
G.3.4	Large Pilot Infiltration Test (Large PIT)	G-13
G.3.5	Deep Infiltration Test	G-14
G.4	Calculation of Design Infiltration Rate of the Native Soils	G-17
G.4.1	The Simplified Approach to Calculating the Design Infiltration Rate of the Native Soils	G-17
G.4.2	The Detailed Approach to Calculating the Design Infiltration Rate of the Native Soils	G-21
G.5	Groundwater Monitoring	G-21
G.6	Characterization of Infiltration Receptor	G-22
G.7	Groundwater Mounding and Seepage Analysis	G-23
G.7.1	Data Requirements	G-24
G.7.2	Analysis Procedures	G-25

APPENDIX H: LID BMP INFEASIBILITY CRITERIA

H-3

REFERENCES

References-3

Tables

Table E.1 – Construction Site Sediment Transport Potential Worksheet.....	E-3
Table F.1 – Runoff Coefficients – “c” Values for the Rational Method.....	F-4
Table F.2 – Manning’s “n” Values for Pipes.....	F-6
Table F.3 – Constants for Inlet Control Equations.....	F-10
Table F.4 – Entrance Loss Coefficients.....	F-13
Table F.5 – Values of Roughness Coefficient “n” for Open Channels.....	F-15
Table G.1. Simple Subsurface Investigation Elements.....	G-5
Table G-2. Standard Subsurface Investigation Elements.....	G-6
Table G-3. Comprehensive Subsurface Investigation Elements.....	G-8
Table G-4. Deep Infiltration Subsurface Investigation Elements.....	G-9
Table G-5. Correction Factors to be Used with In-Situ Saturated Hydraulic Conductivity Measurements to Estimate Design Rates.....	G-19

Table H.1 – Onsite Requirement Infeasibility Criteria Checklist: All Dispersion BMPs and
All Infiltration BMPs..... H-3

Table H.2 – Onsite Requirement Infeasibility Checklist H-5

Appendix A – Glossary

Appendix A: Glossary

Note: The definitions in [Chapter 12.08](#) Kitsap County Code (KCC) shall be reviewed and used where applicable. This appendix provides supplemental definitions only.

Arterial – A road or street primarily for through traffic. The term generally includes roads or streets considered collectors. It does not include local access roads which are generally limited to providing access to abutting property. See also [RCW 35.78.010](#), [RCW 36.86.070](#), and [RCW 47.05.021](#).

Bioengineering – [The combination of biological, mechanical, and ecological concepts \(and methods\) to control erosion and stabilize soil through the use of vegetation or in combination with construction materials.](#)

BMPs – Best Management Practices. See [Chapter 12.08 KCC](#) for definition.

CESCL – Certified Erosion and Sediment Control Lead. See [Chapter 12.08 KCC](#) for definition.

CMP – Corrugated metal pipe

Commercial agriculture – ~~Means these~~ Those activities conducted on lands defined in [RCW 84.34.020\(2\)](#) and activities involved in the production of crops or livestock for commercial trade. An activity ceases to be considered commercial agriculture when the area on which it is conducted is proposed for conversion to a nonagricultural use or has lain idle for more than 5 years, unless the idle land is registered in a federal or state soils conservation program, or unless the activity is maintenance of irrigation ditches, laterals, canals, or drainage ditches related to an existing and ongoing agricultural activity.

Conveyance systems – [The drainage facilities, both natural and manmade, which collect, contain, and provide for the flow of surface and stormwater from the highest points on the land down to a receiving water. The natural elements of the conveyance system include swales and small drainage courses, streams, rivers, lakes, and wetlands. The human-made elements of the conveyance system include gutters, ditches, pipes, channels, and most retention/detention facilities.](#) ~~Includes all portions of the surface water system, either natural or man-made, that transport surface and stormwater runoff.~~

CPEP – Corrugated polyethylene pipe

Discharge point – The location where a discharge leaves the Permittee's MS4 through the Permittee's MS4 facilities/BMPs designed to infiltrate.

Erodible or leachable materials – Wastes, chemicals, or other substances that measurably alter the physical or chemical characteristics of runoff when exposed to rainfall. Examples include erodible soils that are stockpiled, uncovered process wastes, manure, fertilizers, oily substances, ashes, kiln dust, and garbage dumpster leakage.

GSS – Green Stormwater Solutions. ~~(GSS)~~ – See definition for Low Impact Development (LID).

HDPE – High-density polyethylene

HDPP – High-density polyethylene pipe

Highway – A main public road connecting towns and cities.

KCC – Kitsap County Code.

LID – [Low Impact Development. See Chapter 12.08 KCC for definition.](#)

LID principles – Land use management strategies that emphasize conservation, use of onsite natural features, and site planning to minimize impervious surfaces, native vegetation loss, and stormwater runoff.

Outfall – A point source as defined by [40 CFR 122.2](#) at the point where a discharge leaves the permittee’s MS4 and enters a surface receiving waterbody or surface receiving waters. Outfall does not include pipes, tunnels, or other conveyances which connect segments of the same stream or other surface waters and are used to convey primarily surface waters (i.e., culverts).

Onsite stormwater management BMPs – As used in this [manual appendix](#), a synonym for Low Impact Development BMPs. [See Chapter 12.08 KCC for definition.](#)

Permeable pavement – Pervious concrete, porous asphalt, permeable pavers or other forms of pervious or porous paving material intended to allow passage of water through the pavement section. It often includes an aggregate base that provides structural support and acts as a stormwater reservoir.

Pervious surface – Any surface material that allows stormwater to infiltrate into the ground. Examples include lawn, landscape, pasture, native vegetation areas, and permeable pavements.

PVC – [Polyvinyl chloride](#)

Rain garden – A non-engineered shallow landscaped depression, with compost-amended native soils and adapted plants. The depression is designed to pond and temporarily store stormwater runoff from adjacent areas, and to allow stormwater to pass through the amended soil profile.

SDAP – [Site Development Activity Permit](#)

Steep slopes – [Slopes of 30 percent gradient or steeper within a vertical elevation change of at least 10 feet. A slope is delineated by establishing its toe and top, and it is measured by averaging the inclination over at least 10 feet of vertical relief. For the purpose of this definition:](#)

[The toe of a slope is a distinct topographic break in slope that separates slopes inclined at less than 30 percent from slopes 30 percent or steeper. Where no distinct break exists, the toe of a steep slope is the lower-most limit of the area where the ground surface drops 10 feet or more vertically within a horizontal distance of 25 feet; AND](#)

[The top of a slope is a distinct topographic break in slope that separates slopes inclined at less than 30 percent from slopes 30 percent or steeper. Where no distinct break exists, the top of a steep slope is the upper-most limit of the area where the ground surface drops 10 feet or more vertically within a horizontal distance of 25 feet.](#)

Strahler order – The number is assigned to a stream to define the stream size based on a hierarchy of tributaries. The headwaters are the 1st order and downstream segments are defined at confluences (two streams running into each other). At a confluence, if the two streams are not of the same order, then the highest numbered order is maintained on the downstream segment. At a confluence of two streams with the same order, the downstream segment gets the next highest numbered order (e.g., two 1st order streams would be numbered 2nd order downstream). Divergences such as braided streams maintain the same order all the way through the braid, just like it was a single stream; however, divergences that are not braided streams keep the upstream order number and follow the normal hierarchy further downstream.

SWPE – Solid-wall polyethylene

TDA – Threshold discharge area. An area within a project site draining to a single natural discharge location or multiple natural discharge locations that combine within one-quarter mile downstream (as determined by the shortest flowpath). The examples in Figure A-1 illustrate this definition. The purpose of this definition is to clarify how the thresholds of this manual are applied to project sites with multiple discharge points.

Treatment train – A combination of two or more treatment BMPs connected in series.

Underground Injection Control well – A structure built to discharge fluids from the ground surface into the subsurface; a bored, drilled, or driven shaft whose depth is greater than the largest surface dimension; or a dug hole whose depth is greater than the largest surface dimension; or an improved sinkhole, which is a natural crevice that has been modified; or a subsurface fluid distribution system that includes an assemblage of perforated pipes, drain tiles, or other similar mechanisms intended to distribute fluids below the surface of the ground. Examples of UIC wells or subsurface infiltration systems include drywells, drain fields, infiltration trenches with perforated pipe, storm chamber systems with the intent to infiltrate, french drains, bioretention systems intended to distribute water to the subsurface by means of perforated pipe installed below the treatment soil, and other similar devices that discharge to the ground.

Vegetated flow path – A vegetated flow path consists of well-established lawn or pasture, landscaping with well-established groundcover, native vegetation with natural groundcover, or an area that meets Post-Construction Soil Quality and Depth. The groundcover shall be dense enough to help disperse and infiltrate flows and to prevent erosion.

Appendix B – Standard Plan Notes

Appendix B: Standard Plan Notes

The following is a listing of standard plan notes that shall be incorporated in the site improvement plan. All the notes on the list may not pertain to every project. The project engineer may omit non-relevant notes as determined by the director. However, do not renumber the remaining notes. If additional notes are needed for specific aspects, they should be added after the standard plan notes.

B.1 Construction Sequence

1. Apply for and pick up any ~~right-of-way~~[right of way](#) permits from Kitsap County Department of Public Works ([KCPW](#)).
2. Construct stabilized construction entrance(s).
3. Construct ~~siltfilter~~ fence barriers.
4. Construct sedimentation basins.
5. Construct runoff interception and diversion ditches.
6. Clear and grade the minimum site area required for construction of the various phases of work.
7. Provide temporary hydroseeding or other source control stabilization measures on all disturbed soils.
8. Maintain all erosion and sedimentation control [best management practices \(BMPs\) facilities](#) to provide the required protection of downstream water quality.
9. All catch basins and conveyance lines shall be cleaned prior to paving. The cleaning operation shall not flush sediment laden water into the downstream system.
10. Provide permanent site stabilization.
11. Erosion and sedimentation control [BMPs facilities](#) shall not be removed until construction is complete and accepted by Kitsap County.

B.2 Drainage Notes

1. The contractor shall ensure that the drainage is installed and operational prior to commencement of paving work.
2. All steel pipe and parts shall be galvanized. All submerged steel pipes and parts shall be galvanized and have asphalt treatment #1 or better.
3. Drainage stub-outs on individual lots shall be located with a 5-foot-high 2" x 4" stake marked "STORM." The stub out shall extend above surface level and be secured to the stake.
4. Video documentation of pipe interior for alignment and joint connection adequacy shall be provided if not inspected prior to cover.

B.3 Temporary Erosion and Sedimentation Control Maintenance Requirements

1. Erosion and sedimentation control ~~facilities~~ BMPs shall be inspected after each storm event and daily during prolonged rainfall.
2. Necessary repairs or replacement of ~~facilities~~ BMPs shall be accomplished promptly.
3. Sediment deposits shall be removed after each storm event or when the level of deposition reaches approximately one-half the maximum potential depth.
4. Sediment deposits remaining in place after the ESC ~~facilities~~ BMPs are no longer required shall be dressed to conform to the existing grade, prepared and seeded.
5. Temporary ~~Erosion and Sedimentation Control~~ ESC facilities BMPs shall be maintained by:

B.4 Grading Notes

The contractor shall notify the engineer in the event or discovery of poor soils, groundwater or discrepancies in the existing conditions as noted on the plans.

1. Maximum slope steepness shall be 2:1 (Horizontal to Vertical) for cut and fill slopes.
2. Unless otherwise specified, all embankments in the Plan Set shall be constructed in accordance with Section 2-03.3(14)B of the WSDOT Standard Specifications for Road, Bridge and Municipal Construction (WSDOT 2020). Embankment compactions shall conform to Section 2-03.3(14)C, Method B of said Standard Specifications.
3. Embankments designed to impound water shall be compacted to 95 percent maximum density per Section 2-03.3(14)C, Method C of WSDOT Standard Specifications.
4. All areas receiving fill material shall be prepared by removing vegetation, non-complying fill, topsoil and other unsuitable material, by scarifying the surface to provide a bond with the new fill, and where slopes are steeper than 3 horizontal to 1 vertical and the height is greater than 5 feet., by benching into sound competent material as determined by a soils geotechnical engineer.

B.4 General Notes

1. All workmanship and materials shall conform to the MOST CURRENT Standard Specifications for Road, Bridge and Municipal Construction prepared by WSDOT and APWA as adopted by the Kitsap County Department of Public Works (KCPW).
2. Any revisions to the accepted construction plans shall be reviewed and approved by ~~the~~ Kitsap County prior to implementation in the field.
3. The contractor shall maintain a set of the accepted construction drawings onsite at all times while construction is in progress.

4. It shall be the responsibility of the contractor to obtain all necessary permits from the KCPW prior to commencing any work within County ~~right of way~~right of way.
5. The contractor shall be responsible for providing adequate traffic control at all times during construction alongside or within all public roadways. Traffic flow on existing public roadways shall be maintained at all times, unless permission is obtained from the KCPW for road closure and/or detours.
6. The location of existing utilities on this plan is approximate only. The contractor shall ~~contract contact~~ the "Underground Locate" center at 811, and non-subscribing individual utility companies 48 hours in advance of the commencement of any construction activity. The contractor shall provide for protection of existing utilities from damage caused by the contractor's operations.
7. Rockeries or other retaining facilities ~~that sustain a surcharge or exceed~~exceeding 4 feet in height as measured from the foundation require a separate permit prior to construction.
8. A "~~Forestry Practices~~"Timber Harvest permit may be required prior to clearing of the site.

B.5 Inspection Schedule

1. The Contractor shall notify the department of community development to arrange for inspection of the various work activities listed below. All inspections shall be completed prior to proceeding with the next phase of work.
 - a. Establishment of clearing limits.
 - b. Implementation of the various phases of the Erosion and Sedimentation Control Plan.
 - c. Installation of conveyance, Onsite Stormwater Management BMPs, Flow Control BMPs, and Water Quality ~~Treatment~~ BMPs, prior to backfill.
 - d. Protection of Onsite Stormwater Management BMPs.
 - e. Prior to placement of the outlet control structures (orifice size verified prior to installation).
 - f. For public road projects:
 - i. Inspection of prepared sub-grade.
 - ii. Inspection of gravel base placement.
 - iii. Inspection of fine grading prior to paving.
 - iv. Inspection of paving operations.
 - v. Final inspection.
2. The Contractor shall be responsible for all work performed and shall ensure that construction is acceptable to Kitsap County.

3. If inspection is not called for prior to completion of any item of work so designated, special destructive and/or non-destructive testing procedures may be required to ensure the acceptability of the work. If such procedures are required, the Contractor shall be responsible for all costs associated with the testing and/or restoration of the work.

B.6 General Erosion and Sedimentation Control Notes

1. The following erosion and sedimentation control notes apply to all construction site activities at all times, unless otherwise specified on these plans:
2. Approval of this erosion and sedimentation control plan does not constitute an acceptance of the permanent road or drainage design.
3. The owner and his/her contractor shall be responsible at all times for preventing silt-laden runoff from discharging from the project site. Failure by the owner and/or contractor can result in a fine. The designated temporary contact person noted on this plan shall be available for contact by telephone on a 24-hour basis throughout construction and until the project has been completed and accepted by ~~the~~ [Kitsap County](#).
4. The implementation of these ESC plans and the construction, maintenance, replacement and upgrading of these ~~facilities-BMPs~~ is the responsibility of the owner and/or contractor from the beginning of construction until all construction is completed and accepted by [Kitsap](#)~~the~~ [County](#) and the site is stabilized.
5. Prior to beginning any work on the project site, a pre-construction conference shall be held, and shall be attended by the owner or owner's representative, the general contractor, the project engineer, representatives from affected utilities, and a representative of Kitsap County.
6. The ~~erosion and sedimentation control~~[ESC facilities-BMPs](#) shown on this plan are ~~to be~~ considered adequate basic requirements for the anticipated site conditions. During construction, deviations from this plan may be necessary in order to maintain water quality. Minor departures from this plan are permitted subject to the approval of the [County](#) inspector. However, except for emergency situations, all other deviations from this plan shall be designed by the project engineer and approved by Kitsap County prior to installation.
7. All erosion and sedimentation control measures shall be inspected by the owner and/or contractor on a frequent basis and immediately after each rainfall and maintained as necessary to insure their continued functioning. All sediment shall be removed from silt fences, straw bales, sediment ponds, etc. prior to the sediment reaching 1/3 its maximum potential depth.
8. At no time shall concrete, concrete ~~byproducts~~[products](#), vehicle fluids, paint, chemicals, or other polluting matter be permitted to discharge to the temporary or permanent drainage system, or to discharge from the project site.

9. Permanent detention/retention ponds, pipes, tanks or vaults may only be used for sediment containment when specifically indicated on these plans.
10. Redirect sheet flow, block drain inlets and/or curb openings in pavement and install flow diversion measures to prevent construction silt laden runoff and debris from entering excavations and finish surfaces for bioretention facilities and permeable pavements.
11. Where amended soils, bioretention facilities, and permeable pavements are installed, these areas shall be protected at all times from being over-compacted. If areas become compacted, remediate and till soil in accordance with [the Kitsap](#) County requirements at no additional cost in order to restore the system's ability to infiltrate.
12. Install flow diversion measures outside of the Critical Root Zone of trees to be protected. At no time shall construction stormwater be directed towards trees to be protected. Construction stormwater shall not pond within a tree's critical root zone.

B.7 Minimum Erosion and Sedimentation Control Requirements

1. All exposed and unworked soils, including soil stockpiles, shall be stabilized by suitable application of BMPs that protect soil from the erosive forces of raindrop impact and flowing water. Applicable practices include, but are not limited to vegetative establishment, mulching, plastic covering, and the early application of gravel base on areas to be paved. From October 1 to April 30, no soils shall remain unstabilized for more than 2 days. From May 1 to September 30, no soils shall remain unstabilized for more than 7 days.
2. At all times of the year, the contractor shall have sufficient materials, equipment and labor onsite to stabilize and prevent erosion from all denuded areas within 12 hours as site and weather conditions dictate.
3. From October 1 to April 30, the project engineer shall visit the development site a minimum of once per week for the purpose of inspecting the [erosion and sedimentation control ESC facilities BMPs](#), reviewing the progress of construction, and verifying the effectiveness of the erosion control measures being undertaken. The project engineer shall immediately inform [the Kitsap](#) County of any problems or potential problems observed during said site visits, as well as of any recommended changes in the erosion control measures to be undertaken. When requested by [the Kitsap](#) County, the project engineer shall provide [the Kitsap](#) County with written records of said weekly site visits, including dates of visits and noted site observations.
4. In the event that ground on a project site is left bare after September 30, [the Kitsap](#) County may issue a Stop Work Order for the entire project until satisfactory controls are provided. In addition, the Owner will be subject to the penalties provided in [Chapter Section 12.32](#) of the Kitsap County Code.

5. In the event that ground on a project site is left bare after September 30, and [the Kitsap County](#) is unsuccessful in contacting the Owner or his/her designated emergency contact person, [the Kitsap County](#) may enter the project site and install temporary ground cover measures and bill the Owner for all expenses incurred by [the Kitsap County](#). These costs will be in addition to any monetary penalties levied against the Owner.
6. Clearing limits, setbacks, buffers, and sensitive or critical areas such as steep slopes, wetlands and riparian corridors shall be clearly marked in the field and inspected by Kitsap County Department of Community Development prior to commencement of land clearing activities. During the construction period, no disturbance beyond the flagged clearing limits shall be permitted. The flagging shall be maintained by the applicant/contractor for the duration of construction.
7. Adjacent properties shall be protected from sediment deposition by appropriate use of vegetative buffer strips, sediment barriers or filters, dikes or mulching, or by a combination of these measures and other appropriate BMPs.
8. Sediment ponds and traps, perimeter dikes, sediment barriers and other BMPs intended to trap sediment onsite shall be constructed as a first step in grading. These BMPs shall be functional before land disturbing activities take place. Earthen structures such as dams, dikes, and diversions shall be stabilized according to the timing indicated in item (1) above.
9. Cut and fill slopes shall be constructed in a manner that will minimize erosion. Roughened soil surfaces are preferred to smooth surfaces. Interceptors should be constructed at the top of long, steep slopes which have significant areas above that contribute runoff. Concentrated runoff should not be allowed to flow down the face of a cut or fill slope unless contained within an adequate channel or pipe slope drain. Wherever a slope face crosses a water seepage plane, adequate drainage or other protection should be provided. In addition, slopes should be stabilized in accordance with item (1) above.
10. Properties and waterways downstream from development sites shall be protected from erosion due to increases in the volume, velocity, and peak flow rate of stormwater runoff from the development site by the implementation of appropriate BMPs to minimize adverse downstream impacts.
11. All temporary onsite conveyance channels shall be designed, constructed and stabilized to prevent erosion from the expected flow velocity from a 2-year frequency, 24-hour duration storm for the post-development condition. Stabilization adequate to prevent erosion of outlets, adjacent streambanks, slopes and downstream reaches shall be provided at the outlets of all conveyance systems.

12. All storm drain inlets made operable during construction shall be protected so that stormwater runoff shall not enter the conveyance system without first being filtered or otherwise treated to remove sediment. After proper written application, the requirement for inlet protection may be waived by [the Kitsap County](#) on a site-specific basis when the conveyance system downstream of the inlet discharges to an appropriate sediment containment BMP and the conveyance system can be adequately cleaned following site stabilization.
13. The construction of underground utility lines shall be limited, where feasible, to no more than 500 feet of open trench at any one time. Where consistent with safety and space considerations, excavated material shall be placed on the uphill side of the trench. Dewatering devices shall discharge to an appropriate sediment trap or pond, preceded by adequate energy dissipation, prior to runoff leaving the site.
14. Wherever construction vehicle access routes intersect paved roads, provisions shall be made to minimize the transport of sediment (mud) onto the paved road by use of appropriate BMPs such as a Stabilized Construction Entrance. If sediment is transported onto a road surface, the roads shall be cleaned thoroughly, as a minimum, at the end of each day. Sediment shall be removed from roads by shoveling or sweeping and be transported to a controlled sediment disposal area. Street washing shall be allowed only after sediment is removed in this manner.
15. All temporary erosion and sediment control BMPs shall be removed within 30 days after final site stabilization is achieved or after the temporary BMPs are no longer needed. Trapped sediment shall be removed or stabilized onsite. Disturbed soil areas resulting from removal of temporary BMPs shall be permanently stabilized. The removal of temporary erosion and sediment control BMPs may not be required for those projects, such as single family plats, that will be followed by additional construction under a different permit. In these circumstances, the need for removing or retaining the measures will be evaluated on a site-specific basis.
16. Dewatering devices shall discharge into an appropriate sediment trap or pond, designed to accept such a discharge, preceded by adequate energy dissipation, prior to runoff leaving the site.
17. All pollutants other than sediment that occur onsite during construction shall be handled and legally disposed of in a manner that does not cause contamination of storm or surface waters. Pollutants of concern include, but are not limited to, fuels, lubricants, solvents, concrete ~~bi-products~~[byproducts](#) and construction materials

18. Protect all LID BMPs, including but not limited to bioretention, rain garden, and permeable pavement, from sedimentation through installation and maintenance of erosion and sediment control BMPs on portions of the site that drain into such BMPs. Restore the BMPs to their fully functioning condition if they accumulate sediment during construction. Prevent compaction in bioretention and rain garden BMPs by excluding construction equipment and foot traffic. Protect lawn and landscaped areas from compaction by construction equipment. Keep all heavy equipment off existing soils under LID [facilities-BMPs](#) that have been excavated to final grade to retain infiltration rate of the soils.
19. All temporary and permanent erosion and sediment control BMPs shall be maintained and repaired as needed to assure continued performance of their intended function. All maintenance and repair shall be conducted in accordance with the manual. The Applicant shall be responsible for assuring that any such facilities damaged during floods, storms or other adverse weather conditions are immediately returned to normal operating condition.
20. A performance covenant or performance surety shall be required for all projects to ensure compliance with the approved erosion and sediment control plan, as outlined in [ChapterSection](#) 12.12 of the Kitsap County Code.

Appendix C – Site Assessment and Planning Packet

Appendix C: Site Assessment and Planning Packet

Site Assessment and Planning Packet

Instructions for completing this packet:

- ✔ This packet is to be completed during preliminary site assessment and planning, and shall be submitted with the preliminary plan application
- ✔ See Appendix A for definitions of terms used in this packet
- ✔ See Volume II, Chapter 1 for submittal requirements

The Goals of this packet are to:

- ✔ Provide basic project information
- ✔ Document how the project proposes to minimize:
 - Impervious surfaces
 - Loss of native vegetation
 - Stormwater runoff
- ✔ Demonstrate how the project proposes to comply with Minimum Requirement #5 – On-site Stormwater Management

A PROJECT INFORMATION

Permit No. (provided by County) _____

Project Address or Project Boundaries: _____

Parcel No. _____

Project Type: Residential Commercial Industrial Public

Project is: New or redevelopment Remodel Retrofit Combination (describe below)

Project Description:

APPLICANT INFORMATION:

Company/Agency/Owner: _____

Contact Person: _____

Address: _____

Phone: _____

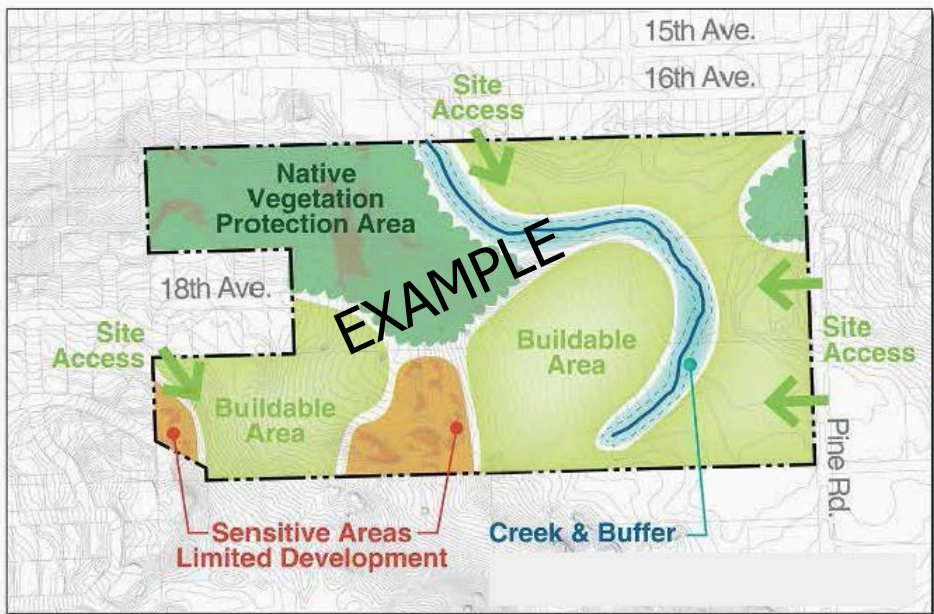
Email: _____

Signature: _____

Date: _____

B CREATE SITE COMPOSITE MAP

Develop a composite site map as you collect site information in Section C. See the example below. This map must be submitted as part of the completed packet, and will be used as a basis for the site design.





EXISTING SITE INVENTORY AND ANALYSIS CHECKLIST

Add items to map

Use this portion of the packet to document the site inventory and analysis. For additional information on each portion of the analysis, refer to Volume I, Chapter 2 in the Kitsap Stormwater Design Manual.

1. PROJECT BOUNDARIES AND STRUCTURES

- Identify/Delineate on map:**
- Project site boundaries (limits of disturbance)
- Existing and proposed buildings
- Required infiltration setbacks (please describe) _____
- Location and extent of proposed foundations and footing drains

2. SOILS

- Characterize existing soil type(s): _____
- What is the depth to seasonal high groundwater (feet)? _____
- Is bedrock present? Yes No If yes, depth (feet): _____
- What is the long-term design native soil infiltration rate (inch/hour): _____
- Identify source(s) of information used: _____

3. CRITICAL AREAS

- Identify and map any Critical Areas located on the project site and within the project vicinity**
- Streams: _____
- Wetlands: _____
- Floodplains: _____
- Riparian areas: _____
- Critical aquifer recharge areas: _____
- Geologically hazardous areas: _____
- Other: _____

See the County's Critical Areas Ordinance website for more information
http://www.kitsapgov.com/dcd/lu_env/cao/cao.htm

4. DEWATERING

- Provide estimated groundwater dewatering flow rates during construction: _____

5. TOPOGRAPHY

- Describe site topography and slopes: _____
- Identify/Delineate on map:**
- Areas of flat ($\leq 5\%$), moderate ($5\% - 15\%$), and steep ($\geq 15\%$) slopes
- Closed depressions



6. HYDROLOGIC PATTERNS & FEATURES

- Identify/Delineate on map:**
- Sub-basin(s) or Threshold Discharge Area(s) (TDA)
- Existing drainage swales and ditches (please describe) _____
- Location(s) of any natural seeps or springs (please describe) _____
- Existing discharge location(s) from each sub-basin or TDA and overall project site: (please describe) _____
- Signs of existing erosion (please describe) _____
- Other: _____

7. VEGETATION

- Native vegetation type(s): _____
- Approximate tree canopy coverage (acres)^a: _____
- Number of trees (greater than 4-inch diameter)^b: _____
- Identify source(s) of information used: _____

Notes:

- a Tree canopy area may be estimated from current aerial photographs and/or documented field observations. Mark on composite map and provide copy of source information
- b Number of trees with diameter equal to or greater than 4 inches may be determined through existing survey or estimated based on documented field observations by a qualified individual.

8. LAND USE CONTROLS

- What is the project site zoning? _____
- Describe landscaping requirements: _____
- Describe parking requirements: _____
- Describe any applicable comprehensive plan designation, zoning classification, and/or overlay districts that may apply to the site: _____
- Does a Shoreline Master Program apply to the site? Yes No
If yes, describe: _____
- Other: _____

9. ACCESS

- Identify/Delineate on map:**
- Roads, driveways, and other points of ingress and egress within 50 feet of the project site
- Identify the street classification of the street that will provide access to the site, per the Kitsap County Road Standards: _____
- Identify frontage improvement requirements: _____
- Identify and Describe any other geometric design requirements that could impact the amount of impervious surface coverage on the site and the location of the access road/driveway: _____

10. UTILITY AVAILABILITY AND CONFLICTS

- Identify/Delineate on map:**
- Existing utilities and easements present on and adjacent to the project site, including utility owner. Also note any utility or easement setback requirements that affect site planning: _____
- Existing utilities that may need to be moved and new utilities that may need to be extended to the site: _____



D EXISTING AND PROPOSED SITE LAND COVER AREAS

Fill in the table below to summarize existing and propose site land cover areas. **If the project is implementing Threshold Discharge Areas (TDAs), complete one table for each TDA.** The completed table will be used to assess the proposed plans for minimizing impervious areas, loss of vegetation, and stormwater runoff.

	Existing Condition	Proposed Condition
Vegetated Areas		
Tree canopy (acres) ^a		
Tree units (#) ^a		
Landscape area (acres)		
Total project site vegetated area (acres)		
Total project site vegetated area (%)		
Hard Surface Areas		
Hard surface (acres)		
Total project site impervious area (%)		
Change		
Increase/decrease in vegetated areas (acres)		
Increase/decrease in vegetated areas (%)		
Increase/decrease in hard surface areas (acres)		
Increase/decrease in hard surface areas (%)		

Notes:

a Copy values from Part C7 **if not using TDAs**

E POTENTIAL LID BMP MATRIX

For each LID BMP being evaluated, use the infeasibility criteria in Appendix H to determine whether the LID BMP is infeasible for your project.

Document the result of that evaluation here. **If implementing TDAs, complete one matrix for each TDA.**

	Feasibility/Infeasibility Evaluation			If infeasible, provide justification
	Feasible	Infeasible	Not Applicable	
Post-Construction Soil Quality and Depth				
Full Dispersion				
Bioretention				
Downspout Dispersion				
Perforated Stubout Connection				
Retain Existing Trees				
Permeable Pavement				
Sheet Flow Dispersion				
Concentrated Flow Dispersion				
Vegetated Roofs				
Minimal Excavation Foundations				
Rain Water Harvesting				
New Trees				

Appendix D – Determining Construction Site Sediment Damage Potential

Appendix D: Determining Construction Site Sediment Damage Potential

The following rating system allows objective evaluation of a particular development site's potential to discharge sediment. Permittees may use the rating system below or develop [an](#) alternative process designed to identify site-specific features, which indicate that the site must be inspected prior to clearing and construction. Any alternative evaluation process must be documented and provide for equivalent environmental review.

Step 1 is to determine if there is a sediment/erosion sensitive feature downstream of the development site. If there is such a site downstream complete [Step 2](#)~~step two~~, assessment of hydraulic nearness. If there is a sediment/erosion sensitive feature and it is hydraulically near the site, then go to [Step 3](#)~~step three~~ to determine the construction site sediment transport potential.

Step 1 – Sediment/Erosion Sensitive Feature Identification

Sediment/erosion sensitive features are areas subject to significant degradation due to the effect of sediment deposition or erosion. Special protection ~~must be provided to protect them~~[measures for these areas must be provided](#).

Sediment/erosion sensitive features include but are not limited to:

- A. Salmonid bearing freshwater streams and their tributaries or freshwater streams that would be Salmonid bearing if not for anthropogenic barriers;
- B. Lakes;
- C. Category I, II, and III wetlands;
- D. Marine near-shore habitat;
- E. Sites containing contaminated soils where erosion could cause dispersal of contaminants;
- F. Steep slopes (25 percent or greater) associated with one of the above features.

Identify any sediment/erosion sensitive features and proceed to [Step 2](#)~~step two~~. If there are none, the assessment is complete.

Step 2 – Hydraulic Nearness Assessment

Sites are hydraulically near a feature if the pollutant load and peak quantity of runoff from the site will not be naturally attenuated before entering the feature. The conditions that render a site hydraulically near to a feature include, but are not limited to, the following:

- A. The feature or a buffer to protect the feature is within 200 ~~feet~~feet downstream of the site.
- B. Runoff from the site is tight-lined to the feature or flows to the feature through a channel or ditch.

A site is not hydraulically near a feature if one of the following takes place to provide attenuation before runoff from the site enters the feature:

- 1. Sheet flow through a vegetated area with dense ground cover. ([Western Washington Phase II Municipal Stormwater Permit, January 17, 2007 Appendix 7—Determining Sediment Damage Potential, Page 2 of 3](#))
- 2. Flow through a wetland not included as a sensitive feature.
- 3. Flow through a significant shallow or adverse slope, not in a conveyance channel, between the site and the sensitive feature.

Identify any of the sediment/erosion sensitive features from [Step 1](#)~~step one~~ that are hydraulically near the site and proceed to [Step 3](#)~~step three~~. If none of the sediment/erosion sensitive features are hydraulically near the site, the assessment is complete.

Step 3 – Construction Site Sediment Transport Potential

Using the [Appendix E](#) worksheet ~~below~~, determine the total points for each development site. Assign points based on the most critical condition that affects 10 percent or more of the site. If soil testing has been performed on site, the results should be used to determine the predominant soil type on the site. Otherwise, soil information should be obtained from the county soil survey to determine Hydrologic Soil Group (Table of Engineering Index Properties for [part D in Appendix E](#)~~step 4.D~~) and Erosion Potential (Table of Water Features for [part E in Appendix E](#)~~step 4.E~~).

When using the county soil survey, the dominant soil type may be in question, particularly when the site falls on a boundary between two soil types or when one of two soil types may be present on a site. In this case, the soil type resulting in the most points on the rating system will be assumed unless site soil tests indicate that another soil type dominates the site. Use the point score from Step 3 to determine whether the development site has a high potential for sediment transport off of the site.

<u>Total Score</u>	<u>Transport Rating</u>
<100	Low
≥100	High

A high transport rating indicates a higher risk that the site will generate sediment contaminated runoff.

Appendix E – Construction Site Sediment Transport Potential Worksheet

Appendix E: Construction Site Sediment Transport Potential Worksheet

Table E.1 – Construction Site Sediment Transport Potential Worksheet.	
<u>A. Existing slope of site (average, weighted by aerial extent)</u>	
<u>2% or less</u>	<u>0</u>
<u>>2–5%</u>	<u>5</u>
<u>>5–10%</u>	<u>15</u>
<u>>10–15%</u>	<u>30</u>
<u>>15%</u>	<u>50</u>
<u>B. Site area to be cleared and/or graded</u>	
<u><5,000 square feet (sf)</u>	<u>0</u>
<u>5,000 sf–1 acre</u>	<u>30</u>
<u>>1 acre</u>	<u>50</u>
<u>C. Quantity of cut and/or fill on site</u>	
<u><500 cubic yards</u>	<u>0</u>
<u>500–5,000 cubic yards</u>	<u>5</u>
<u>>5,000–10,000 cubic yards</u>	<u>10</u>
<u>>10,000–20,000 cubic yards</u>	<u>25</u>
<u>>20,000 cubic yards</u>	<u>40</u>
<u>D. Runoff potential of predominant soils (Natural Resources Conservation Service)</u>	
<u>Hydrologic soil group A</u>	<u>0</u>
<u>Hydrologic soil group B</u>	<u>10</u>
<u>Hydrologic soil group C</u>	<u>20</u>
<u>Hydrologic soil group D</u>	<u>40</u>
<u>E. Erosion potential of predominant soils (Unified Classification System)</u>	
<u>GW, GP, SW, SP soils</u>	<u>0</u>
<u>Dual classifications (GW-GM, GP-GM, GW-GC, GP-GC, SW-SM, SW-SC, SP-SM, SP-SC)</u>	<u>10</u>
<u>GM, GC, SM, SC soils</u>	<u>20</u>
<u>ML, CL, MH, CH soils</u>	<u>40</u>

Table E.1 (continued) – Construction Site Sediment Transport Potential Worksheet.	
<u>F. Surface or groundwater entering site identified and intercepted¹</u>	
<u>Yes</u>	<u>0</u>
<u>No</u>	<u>25</u>
<u>G. Depth of cut or height of fill > 10 feet</u>	
<u>Yes</u>	<u>25</u>
<u>No</u>	<u>0</u>
<u>H. Clearing and grading will occur in the wet season (October 1 – May 1)</u>	
<u>Yes</u>	<u>50</u>
<u>No</u>	<u>0</u>
<u>Total Points</u>	

¹ If no surface or groundwater enters the site, assign 0 points

A. Existing slope of site (average, weighted by aerial extent): _____ Points

2% or less	0
>2-5%	5
>5-10%	15
>10-15%	30
>15%	50

B. Site Area to be cleared and/or graded:

<5,000 sq. ft	0
5,000 sq. ft. — 1 acre	30
>1 acres	50

C. Quantity of cut and/or fill on site:

<500 cubic yards	0
500 — 5,000 cubic yards	5
>5,000 — 10,000 cubic yards	10
>10,000 — 20,000 cubic yards	25
>20,000 cubic yards	40

D. Runoff potential of predominant soils (Natural Resources Conservation Service):

Hydrologic soil group A	0
Hydrologic soil group B	10

Hydrologic soil group C	20
Hydrologic soil group D	40
E. Erosion Potential of predominant soils (Unified Classification System):	
GW, GP, SW, SP soils	0
Dual classifications (GW-GM, GP-GM, GW-GC, GP-GC, SW-SM, SW-SC, SP-SM, SP-SC).....	10
GM, GC, SM, SC soils	20
ML, CL, MH, CH soils.....	40
F. Surface or Groundwater entering site identified and intercepted⁴:	
Yes — 0	
No.....	25
G. Depth of cut or height of fill >10 feet:	
Yes	25
No.....	0
H. Clearing and grading will occur in the wet season (October 1—May 1):	
Yes — 50	
No — 0	
TOTAL POINTS _____	

Appendix F – Hydrologic/Hydraulic Modeling Methods

Appendix F: Hydrologic/Hydraulic Modeling Methods

This appendix presents detailed discussion on Kitsap County approved methods for the hydrologic/hydraulic analysis and design of pipe conveyance, culverts, and open channel systems. For public road projects, the WSDOT *Highway Runoff Manual* hydrologic/hydraulic methods may be used if preferred over these methods.

F.1 Design Flow Rate

As discussed in [Volume II](#), Section 4.2 ~~of Volume II of this manual~~, the Rational Method, the Santa Barbara Unit Hydrograph (SBUH) Method, [the Western Washington Hydrology Model \(WWHM\)](#), and ~~the MGS Flood Model~~ may all be used to determine the conveyance design flow rates provided that the basin limitations for each option are met. The Rational Method is preferred by Kitsap County for design of systems serving smaller contributing basins primarily because it tends to provide higher conveyance design flow rates than hydrograph methods, resulting in a more conservative design with a built-in safety factor.

Only the Rational Method [equation formula](#) is provided below; refer to [Volume III, Chapter 2 of the Ecology Manual](#) for instructions on using the SBUH Method and WWHM, and consult with the model user manual for a complete description on how to use ~~the MGS Flood Model~~. With the Rational Method, peak runoff rates can be determined using Equation F-1 ~~below~~:

Equation F-1: Rational Method

$$Q = C * I * A \tag{F-1}$$

where: Q = ~~r~~Runoff ~~in~~ (cubic feet per second [(cfs])
C = ~~r~~Runoff coefficient ([dimensionless units](#)); see [Table F.1](#)
I = ~~r~~Rainfall intensity ~~in~~ (inches per hour [[in/hr](#)]); see [Figure F.1](#)
A = ~~c~~Contributing area ~~in~~ (acres)

~~The runoff coefficient (C) should be based on Table F.1, Runoff Coefficients – 'C' Values for the Rational Method.~~

~~The rainfall intensity (I) should be based on Figure F.1, Rainfall Intensity-Duration Curves, prepared by the U.S. Weather Bureau for the Mayfield-Bremerton-Kitsap County-Summer areas.~~

~~(See separate file for Public Review Draft figures.)~~

Figure F.1 – Rainfall Intensity-Duration Curves.

Table F.1 – Runoff Coefficients – “c” Values for the Rational Method.		
Undeveloped Land	“C” Flat (0–5%)	“C” Rolling (>5%)
<u>Wood and forest</u>	<u>0.05</u>	<u>0.10</u>
<u>Sparse trees and ground cover</u>	<u>0.10</u>	<u>0.15</u>
<u>Light grass to bare ground</u>	<u>0.15</u>	<u>0.20</u>
Developed Area	“C” Flat (0–5%)	“C” Rolling (>5%)
<u>Pavement and roofs</u>	<u>0.90</u>	<u>0.90</u>
<u>Gravel roads and parking lots</u>	<u>0.75</u>	<u>0.80</u>
<u>City business</u>	<u>0.85</u>	<u>0.90</u>
<u>Apartment dwelling areas</u>	<u>0.80</u>	<u>0.85</u>
<u>Industrial areas (heavy)</u>	<u>0.70</u>	<u>0.80</u>
<u>Industrial areas (light)</u>	<u>0.60</u>	<u>0.70</u>
<u>Earth shoulder</u>	<u>0.50</u>	<u>0.50</u>
<u>Playground</u>	<u>NA</u>	<u>NA</u>
<u>Lawns, meadows and pastures</u>	<u>0.20</u>	<u>0.25</u>
<u>Parks and cemeteries</u>	<u>0.15</u>	<u>0.20</u>
Single Family Residential Areas	“C”	
<u>1.0 DU/GA</u>		<u>0.30</u>
<u>2.0 DU/GA</u>		<u>0.36</u>
<u>3.0 DU/GA</u>		<u>0.42</u>
<u>4.0 DU/GA</u>		<u>0.48</u>
<u>5.0 DU/GA</u>		<u>0.60</u>
<u>9.0 – 15.0 DU/GA</u>		<u>0.70</u>

F.2 Conveyance Capacity

This section details modeling methods for determining the conveyance capacity of pipe, culvert, and open channel conveyance systems.

F.2.1 Pipe Conveyance Systems

Two methods of hydraulic analysis of conveyance capacity are used sequentially for the design and analysis of pipe systems. First, the Uniform Flow Analysis method is used for the preliminary design of new pipe systems. Second, the Backwater Analysis method is used to analyze both proposed and existing pipe systems to verify adequate capacity.

Note: Use of the Uniform Flow Analysis method to determine preliminary pipe sizes is only suggested as a first step in the design process and is not required. Results of the Backwater Analysis method determine final pipe sizes in all cases. The director has the authority to waive the requirement for Backwater Analysis as verification.

F.2.1.1 Uniform Flow Analysis Method

This method is used for preliminary sizing of new pipe systems to convey the design flow. It assumes the following:

- Flow is uniform in each pipe (i.e., depth and velocity remain constant throughout the pipe for a given flow).
- Friction head loss in the pipe barrel alone controls capacity. Other head losses (e.g., entrance, exit, junction, etc.) and any backwater effects or inlet control conditions are not specifically addressed.

Each pipe within the system is sized and sloped such that its barrel capacity at normal full flow computed by Manning's equation is equal to or greater than the design flow. The nomograph in Figure F.2 may be used for an approximate solution of Manning's equation (Equation F-2 below). For more precise results, or for partial pipe full conditions, solve Manning's equation directly ([Equation F-2](#)) or use the discharge formula ($Q = A * V$) to solve for the volumetric flow rate ([Equation F-3](#)):

[Equation F-2: Manning's equation](#)

$$V = \frac{1.49}{n} R^{2/3} S^{1/2} \tag{F-2}$$

where: V = velocity (feet per second [fps])
 n = Manning's roughness coefficient; see [Table F.2](#)
 R = hydraulic radius = area/wetted perimeter (ft)
 S = slope of the energy grade line (ft/ft)

or use [Equation F-3](#), the continuity equation, $Q = AV$, such that:

[Equation F-3: Volumetric flow rate equation](#)

$$Q = \frac{1.49}{n} A R^{2/3} S^{1/2} \tag{F-3}$$

where: Q = discharge (cfs)
 V = velocity (fps)
 A = area (sf)
 n = Manning's roughness coefficient; see [Table F.2 below](#)
 R = hydraulic radius = area/wetted perimeter (ft)
 S = slope of the energy grade line (ft/ft)

[Figure F.2 – Nomograph for Sizing Circular Drains Flowing Full.](#)

For pipes flowing partially full, the actual velocity may be estimated from the hydraulic properties shown in Figure F.3 by calculating Q_{full} and V_{full} and using the ratio Q_{design}/Q_{full} to find V and d (depth of flow).

Figure F.3 – Circular Channel Ratios.

Table F.2 provides the recommended Manning's "n" values for preliminary design using the Uniform Flow Analysis method for pipe systems. Note: The "n" values for this method are 15 percent higher in order to account for entrance, exit, junction, and bend head losses.

<u>Table F.2 – Manning’s “n” Values for Pipes.</u>		
<u>Type of Pipe Material</u>	<u>Analysis Method</u>	
	<u>Uniform Flow (Preliminary Design)</u>	<u>Backwater Flow (Capacity Verification)</u>
<u>A. Concrete pipe and LGPECEP pipe</u>	<u>0.014</u>	<u>0.012</u>
<u>B. Annular Corrugated Metal Pipe or Pipe Arch</u>		
<u>1. 2-2/3" x 1/2" corrugation (riveted)</u>		
<u>a. plain or fully coated</u>	<u>0.028</u>	<u>0.024</u>
<u>b. paved invert (40% of circumference paved)</u>		
<u>1) flow at full depth</u>	<u>0.021</u>	<u>0.018</u>
<u>2) flow at 80% full depth</u>	<u>0.018</u>	<u>0.016</u>
<u>3) flow at 60% full depth</u>	<u>0.015</u>	<u>0.013</u>
<u>c. treatment 5</u>	<u>0.015</u>	<u>0.013</u>
<u>2. 3" x 1" corrugation</u>	<u>0.031</u>	<u>0.027</u>
<u>3. 6" x 2" corrugation (field bolted)</u>	<u>0.035</u>	<u>0.030</u>
<u>C. Helical 2-2/3" x 1/2" corrugation and CPE-pipeP</u>	<u>0.028</u>	<u>0.024</u>
<u>D. Spiral rib metal pipe and PVC pipe</u>	<u>0.013</u>	<u>0.011</u>
<u>E. Ductile iron pipe (cement lined)</u>	<u>0.014</u>	<u>0.012</u>
<u>F. SWPE pipe (butt fused only)</u>	<u>0.009</u>	<u>0.009</u>

F.2.1.2 Backwater Analysis Method

The Backwater Analysis Method is used to analyze the capacity of both new and existing pipe systems to convey the required design flow. For both new and existing systems, structures shall be demonstrated to contain the headwater surface (hydraulic grade line) for the specified peak flow rate.

This method incorporates a re-arranged form of Manning's equation expressed in terms of friction slope (i.e., the slope of the energy grade line, in units of ft/ft). The friction slope is used to determine the head loss in each pipe segment due to barrel friction, which can then be combined with other head losses to obtain water surface elevations at all structures along the pipe system.

The backwater analysis begins at the downstream end of the pipe system and is computed back through each pipe segment and structure upstream. The friction, entrance, and exit head losses computed for each pipe segment are added to that segment's tailwater elevation (the water surface elevation at the pipe's outlet) to obtain its outlet control headwater elevation. This elevation is then compared with the inlet control headwater elevation, computed assuming the pipe's inlet alone is controlling capacity using the methods for inlet control presented in [Volume II, Section 4.5](#) and [Appendix F, Section Appendix](#) . The condition that creates the highest headwater elevation determines the pipe's capacity. The approach velocity head is then subtracted from the controlling headwater elevation, and the junction and bend head losses are added to compute the total headwater elevation, which is then used as the tailwater elevation for the upstream pipe segment.

The Backwater Calculation Sheet in Figure F.4 may be used to compile the head losses and headwater elevations for each pipe segment. The numbered columns on this sheet are described in Figure F.5. An example calculation is performed in Figure F.6. [Refer to Figure F.7 and Figure F.8 regarding bend head losses and junction head losses, respectively.](#)

Note: This method should not be used to compute stage/discharge curves for level pool routing purposes. Instead, a more sophisticated backwater analysis using a computer software program is recommended for that purpose.

[Figure F.4 – Backwater Calculation Sheet.](#)

[Figure F.5 – Backwater Calculation Sheet Notes.](#)

[Figure F.6 – Backwater Pipe Calculation Example.](#)

[Figure F.7 – Bend Head Losses in Structure.](#)

[Figure F.8 – Junction Head Loss in Structure.](#)

Computer Applications

There are a number of commercial software programs for use on personal computers that use variations of the Standard Step backwater method for determining water surface profiles. The most common and widely accepted programs include HEC-RAS, published and supported by the United States (US) Army Corps of Engineers Hydraulic Engineering Center, and Stormwater Management Model (SWMM), originally published by US Environmental Protection Agency.

F.2.2 Culverts

Culverts are classified according to which end controls the discharge capacity; the inlet or the outlet end. If water can flow through and out of the culvert faster than it can enter into the culvert, then the culvert is under inlet control. If water can flow into the culvert faster than it can flow through and out, then it is under outlet control ([see Figure F.9](#)).-This section details methods for analyzing conveyance capacity for culverts under inlet and outlet control.

F.2.2.1 Inlet Control Analysis

Nomographs such as those provided in Figure F.10 and Figure F.11 may be used to determine the inlet control headwater depth at design flow for various types of culverts and inlet configurations. These nomographs were originally developed by the Bureau of Public Roads—now the Federal Highway Administration (FHWA)—based on their studies of culvert hydraulics. These and other nomographs can be found in the [FHWA publication *Hydraulic Design of Highway Culverts*, HDS No. #5 \(Report No. FHWA 2012-IP-85-15\), September 1985](#); or the [WSDOT Hydraulic Manual \(WSDOT 2019\)](#).

Figure F.9 – Inlet/Outlet Control Conditions

Figure F.10 – Headwater Depth for Smooth Interior Pipe Culverts with Inlet Control.

Figure F.11 – Headwater Depth for Corrugated Pipe Culvert with Inlet Control.

Also available in the FHWA publication, are the design equations used to develop the inlet control nomographs. These equations, Equations F-4 through F-6, are presented below.

For **unsubmerged** inlet conditions (defined by $Q/AD^{0.5} \leq 3.5$), use Equation F-4 (Form 1) or Equation F-5 (Form 2). Refer to Table F.3 to determine the appropriate form of the equation to use.

Equation F-4: Headwater depth in unsubmerged inlet conditions (Form 1): (F-4)

$$HW/D = H_c/D + K(Q/AD^{0.5})^M - 0.5S^*$$

where:-	<u>HW</u>	=	<u>headwater depth above inlet invert (ft)</u>
	<u>D</u>	=	<u>interior height of culvert barrel (ft)</u>
	<u>H_c</u>	=	<u>specific head (ft) at critical depth ($dc + Vc_2/2g$)</u>
	<u>Q</u>	=	<u>flow (cfs)</u>
	<u>A</u>	=	<u>full cross-sectional area of culvert barrel (sf)</u>
	<u>S</u>	=	<u>culvert barrel slope (ft/ft)</u>
	<u>K</u>	=	<u>constant; see Table F.3</u>
	<u>M</u>	=	<u>constant; see Table F.3</u>

* For mitered inlets, use +0.7S instead of -0.5S.

Equation F-5: Headwater depth in unsubmerged inlet conditions (Form 2): (F-5)

$$HW/D = K(Q/AD^{0.5})^M$$

where:-	<u>HW</u>	=	<u>headwater depth above inlet invert (ft)</u>
	<u>D</u>	=	<u>interior height of culvert barrel (ft)</u>
	<u>Q</u>	=	<u>flow (cfs)</u>
	<u>A</u>	=	<u>full cross-sectional area of culvert barrel (sf)</u>
	<u>K</u>	=	<u>constant; see Table F.3</u>
	<u>M</u>	=	<u>constant; see Table F.3</u>

For **submerged** inlet conditions (defined by $Q/AD^{0.5} \geq 4.0$), use Equation F-6:

[Equation F-6: Headwater depth in submerged inlet conditions](#)

$$HW/D = c_*(Q/AD^{0.5})^2 + Y - 0.5S^* \tag{F-6}$$

- where:
- HW = headwater depth above inlet invert (ft)
 - D = interior height of culvert barrel (ft)
 - H_c = specific head (ft) at critical depth ($d_c + V_{c2}/2g$)
 - Q = flow (cfs)
 - A = full cross-sectional area of culvert barrel (sf)
 - S = culvert barrel slope (ft/ft)
 - K, M, c, Y = constants; see from Table F.3.
 - Y = constant; see Table F.3

* For mitered inlets, use +0.7S instead of -0.5S.

The specified head H_c is determined by Equation F-7:

[Equation F-7: Specified head](#)

$$H_c = d_c + V_c^2/2g \tag{F-7}$$

- where:
- H_c = specified head (ft)
 - d_c = critical depth (ft); see Figure F.13-14
 - V_c = flow velocity at critical depth (fps)
 - g = acceleration due to gravity (32.2 ft/sec²)

Note: Between the unsubmerged and submerged conditions, there is a transition zone ($3.5 < Q/AD^{0.5} < 4.0$) for which there is only limited hydraulic study information. The transition zone is defined empirically by drawing a curve between and tangent to the curves defined by the unsubmerged and submerged equations. In most cases, the transition zone is short, and the curve is easily constructed.

Table F.3 – Constants for Inlet Control Equations.

<u>Shape and Material</u>	<u>Inlet Edge Description</u>	<u>Unsubmerged</u>			<u>Submerged</u>	
		<u>Equation Form</u>	<u>K</u>	<u>M</u>	<u>c</u>	<u>Y</u>
Circular Concrete	Square edge with headwall	1	0.0098	2.0	0.0398	0.67
	Groove end with headwall		0.0078	2.0	0.0292	0.74
	Groove end projecting		0.0045	2.0	0.0317	0.69
Circular CMP	Headwall	1	0.0078	2.0	0.0379	0.69
	Mitered to slope		0.0210	1.33	0.0463	0.75
	Projecting		0.0340	1.50	0.0553	0.54
Rectangular Box	30° to 75° wingwall flares	1	0.026	1.0	0.0385	0.81
	90° and 15° wingwall flares		0.061	0.75	0.0400	0.80
	0° wingwall flares		0.061	0.75	0.0423	0.82
CM Boxes	90° headwall	1	0.0083	2.0	0.0379	0.69
	Thick wall projecting		0.0145	1.75	0.0419	0.64
	Thin wall projecting		0.0340	1.5	0.0496	0.57
Arch CMP	90° headwall	1	0.0083	2.0	0.0496	0.57
	Mitered to slope		0.0300	1.0	0.0463	0.75
	Projecting		0.0340	1.5	0.0496	0.53
Bottomless Arch CMP	90° headwall	1	0.0083	2.0	0.0379	0.69
	Mitered to slope		0.0300	2.0	0.0463	0.75
	Thin wall projecting		0.0340	1.5	0.0496	0.57
Circular with Tapered Inlet	Smooth tapered inlet throat	2	0.534	0.333	0.0196	0.89
	Rough tapered inlet throat		0.519	0.64	0.0289	0.90

Source: FHWA HDS No. 5

F.2.2.2 Outlet Control Analysis

Nomographs such as those provided in Figure F.12 and Figure F.13 may be used to determine the outlet control headwater depth at design flow for various types of culverts and inlets. Outlet control nomographs other than those provided can be found in *FHWA HDS No.5* or the *WSDOT Hydraulic Manual*.

[Figure F.12 – Head for Culverts \(Pipe w/n = 0.012\) Flowing Full with Outlet Control.](#)

[Figure F.13 – Head for Culverts \(Pipe w/n = 0.024\) Flowing Full with Outlet Control.](#)

[Figure F.14 – Critical Depth of Flow for Circular Culverts.](#)

The outlet control headwater depth may also be determined using the simple Backwater Analysis Method presented in [Appendix F](#), Section 0 for analyzing pipe system capacity. This procedure is summarized for culverts by Equation F-8:

[Equation F-8: Outlet control headwater depth \(Backwater Analysis Method\)](#)

$$HW = H + TW - LS \quad (F-1)$$

where:	HW	=	headwater depth above inlet invert (ft)
	H	=	$H_f + H_e + H_{ex}$
	H_f	=	friction loss (ft) = $(V^2 n^2 L) / (2.22 R^{1.33})$ <i>Note:</i> If $(H_f + TW - LS) < D$, adjust H_f such that $(H_f + TW - LS) = D$. This will keep the analysis simple and still yield reasonable results (erring on the conservative side).
	H_e	=	entrance head loss (ft) = $K_e (V^2 / 2g)$
	H_{ex}	=	exit head loss (ft) = $V^2 / 2g$
	TW	=	tailwater depth above invert of culvert outlet (ft) <i>Note:</i> If $TW < (D + d_c) / 2$, set $TW = (D + d_c) / 2$. This will keep the analysis simple and still yield reasonable results.
	L	=	length of culvert (ft)
	S	=	slope of culvert barrel (ft/ft)
	D	=	interior height of culvert barrel (ft)
	V	=	barrel velocity (fps)
	n	=	Manning's roughness coefficient; see from Table F.2.
	R	=	hydraulic radius (ft)
	K_e	=	entrance loss coefficient; see from Table F.4)
	g	=	acceleration due to gravity (32.2 ft/sec ²)
	d_c	=	critical depth (ft); see Figure F.1314

Note: The above procedure should not be used to develop stage/discharge curves for level pool routing purposes because its results are not precise for flow conditions where the hydraulic grade line falls significantly below the culvert crown (i.e., less than full flow conditions).

Table F.4 – Entrance Loss Coefficients.

<u>Type of Structure and Design Entrance</u>	<u>Coefficient, K_e</u>
<u>Pipe, Concrete, PVC, Spiral Rib, DI, and Lined CPE</u>	
<u>Projecting from fill, socket (bell) end</u>	<u>0.2</u>
<u>Projecting from fill, square cut end</u>	<u>0.5</u>
<u>Headwall, or headwall and wingwalls</u>	
<u>Socket end of pipe (groove-end)</u>	<u>0.2</u>
<u>Square-edge</u>	<u>0.5</u>
<u>Rounded (radius = $1/12D$)</u>	<u>0.2</u>
<u>Mitered to conform to fill slope</u>	<u>0.7</u>
<u>End section conforming to fill slope*</u>	<u>0.5</u>
<u>Beveled edges, 33.7° or 45° bevels</u>	<u>0.2</u>
<u>Side- or slope-tapered inlet</u>	<u>0.2</u>
<u>Pipe, or Pipe-Arch, Corrugated Metal and Other Non-Concrete or D.I.</u>	
<u>Projecting from fill (no headwall)</u>	<u>0.9</u>
<u>Headwall, or headwall and wingwalls (square-edge)</u>	<u>0.5</u>
<u>Mitered to conform to fill slope (paved or unpaved slope)</u>	<u>0.7</u>
<u>End section conforming to fill slope*</u>	<u>0.5</u>
<u>Beveled edges, 33.7° or 45° bevels</u>	<u>0.2</u>
<u>Side- or slope-tapered inlet</u>	<u>0.2</u>
<u>Box, Reinforced Concrete</u>	
<u>Headwall parallel to embankment (no wingwalls)</u>	
<u>Square-edged on 3 edges</u>	<u>0.5</u>
<u>Rounded on 3 edges to radius of $1/12$ barrel dimension or beveled edges on 3 sides</u>	<u>0.2</u>
<u>Wingwalls at 30° to 75° to barrel</u>	
<u>Square-edged at crown</u>	<u>0.4</u>
<u>Crown edge rounded to radius of $1/12$ barrel dimension or beveled top edge</u>	<u>0.2</u>
<u>Wingwall at 10° to 25° to barrel</u>	
<u>Square-edged at crown</u>	<u>0.5</u>
<u>Wingwalls parallel (extension of sides)</u>	
<u>Square-edged at crown</u>	<u>0.7</u>
<u>Side- or slope-tapered inlet</u>	<u>0.2</u>
* Note: "End section conforming to fill slope" are the sections commonly available from manufacturers. From limited hydraulic tests they are equivalent in operation to a headwall in both inlet and outlet control. Some end sections incorporating a closed taper in their design have a superior hydraulic performance.	

F.2.3 Open Channels

As discussed in [Volume II, Section 4.6.2](#) of [Volume II of this manual](#), there are three acceptable methods of analysis for sizing and analyzing the capacity of open channels:

1. Manning's equation for preliminary sizing;
2. Direct Step backwater method; and
3. Standard Step backwater method.

Each of these methods are detailed in the sections below.

F.2.3.1 Manning's Equation for Preliminary Sizing

Manning's equation is used for preliminary sizing of open channel reaches of uniform cross-section and slope (i.e., prismatic channels) and uniform roughness. This method assumes the flow depth (or normal depth) and flow velocity remain constant throughout the channel reach for a given flow.

The charts in Figure 4.11 and Figure 4.12 may be used to obtain graphic solutions of Manning's equation for common ditch sections. For conditions outside the range of these charts or for more precise results, Manning's equation can be solved directly from its classic forms shown in Equations F-2 and F-3.

Table F.5 provides a reference for selecting the appropriate "*n*" values for open channels. A number of engineering reference books, such as *Open-Channel Hydraulics* by V.T. Chow, may also be used as guides to select "*n*" values. Figure 4.13 contains the geometric elements of common channel sections useful in determining area *A*, wetted perimeter *WP*, and hydraulic radius ($R = A/WP$).

If flow restrictions occur that raise the water level above normal depth within a given channel reach, a backwater condition (or subcritical flow) is said to exist. This condition can result from flow restrictions created by a downstream culvert, bridge, dam, pond, lake, etc., and even a downstream channel reach having a higher flow depth. If backwater conditions are found to exist for the design flow, a backwater profile shall be computed to verify that the channel's capacity is still adequate as designed. The Direct Step or Standard Step backwater methods presented in this section may be used for this purpose.

Table F.5 – Values of Roughness Coefficient “n” for Open Channels.

<u>Type of Channel and Description</u>	<u>Manning's “n”* (normal)</u>
A. Constructed Channels	
<u>a. Earth, straight and uniform</u>	
<u>1. Clean, recently completed</u>	<u>0.018</u>
<u>2. Gravel, uniform section, clean</u>	<u>0.025</u>
<u>3. With short grass, few weeds</u>	<u>0.027</u>
<u>b. Earth, winding and sluggish</u>	
<u>1. No vegetation</u>	<u>0.025</u>
<u>2. Grass, some weeds</u>	<u>0.030</u>
<u>3. Dense weeds or aquatic plants in deep channels</u>	<u>0.035</u>
<u>4. Earth bottom and rubble sides</u>	<u>0.030</u>
<u>5. Stony bottom and weedy banks</u>	<u>0.035</u>
<u>6. Cobble bottom and clean sides</u>	<u>0.040</u>
<u>c. Rock lined</u>	
<u>1. Smooth and uniform</u>	<u>0.035</u>
<u>2. Jagged and irregular</u>	<u>0.040</u>
<u>d. Channels not maintained, weeds and brush uncut</u>	
<u>1. Dense weeds, high as flow depth</u>	<u>0.080</u>
<u>2. Clean bottom, brush on sides</u>	<u>0.050</u>
<u>3. Same as #2, highest stage of flow</u>	<u>0.070</u>
<u>4. Dense brush, high stage</u>	<u>0.100</u>
B. Natural Streams	
<u>B-1 Minor streams (top width at flood stage < 100 feet.)</u>	
<u>a. Streams on plain</u>	
<u>1. Clean, straight, full stage no rifts or deep pools</u>	<u>0.030</u>
<u>2. Same as #1, but more stones and weeds</u>	<u>0.035</u>
<u>3. Clean, winding, some pools and shoals</u>	<u>0.040</u>
<u>4. Same as #3, but some weeds</u>	<u>0.040</u>
<u>5. Same as #4, but more stones</u>	<u>0.050</u>
<u>6. Sluggish reaches, weedy deep pools</u>	<u>0.070</u>
<u>7. Very weedy reaches, deep pools, or floodways with heavy stand of timber and underbrush</u>	<u>0.100</u>
<u>b. Mountain streams, no vegetation in channel, banks usually steep, trees and brush along banks submerged at high stages</u>	
<u>1. Bottom: gravel, cobbles, and few boulders</u>	<u>0.040</u>
<u>2. Bottom: cobbles with large boulders</u>	<u>0.050</u>

Table F.5 (continued) – Values of Roughness Coefficient “n” for Open Channels.

<u>Type of Channel and Description (continued)</u>	<u>Manning's “n”* (normal)</u>
B-2 Floodplains	
<u>a. Pasture, no brush</u>	
<u>1. Short grass</u>	<u>0.030</u>
<u>2. High grass</u>	<u>0.035</u>
<u>b. Cultivated areas</u>	
<u>1. No crop</u>	<u>0.030</u>
<u>2. Mature row crops</u>	<u>0.035</u>
<u>3. Mature field crops</u>	<u>0.040</u>
<u>c. Brush</u>	
<u>1. Scattered brush, heavy weeds</u>	<u>0.050</u>
<u>2. Light brush and trees</u>	<u>0.060</u>
<u>3. Medium to dense brush</u>	<u>0.070</u>
<u>4. Heavy, dense brush</u>	<u>0.100</u>
<u>d. Trees</u>	
<u>1. Dense willows, straight</u>	<u>0.150</u>
<u>2. Cleared land with tree stumps, no sprouts</u>	<u>0.040</u>
<u>3. Same as #2, but with heavy growth of sprouts</u>	<u>0.060</u>
<u>4. Heavy stand of timber, a few down trees, little undergrowth, flood stage below branches</u>	<u>0.100</u>
<u>5. Same as #4, but with flood stage reaching branches</u>	<u>0.120</u>

* *Note: These “n” values are “normal” values for use in analysis of channels. For conservative design of channel capacity, the maximum values listed in other references should be considered. For channel bank stability, the minimum values should be considered.*

F.2.3.2 Direct Step Backwater Method

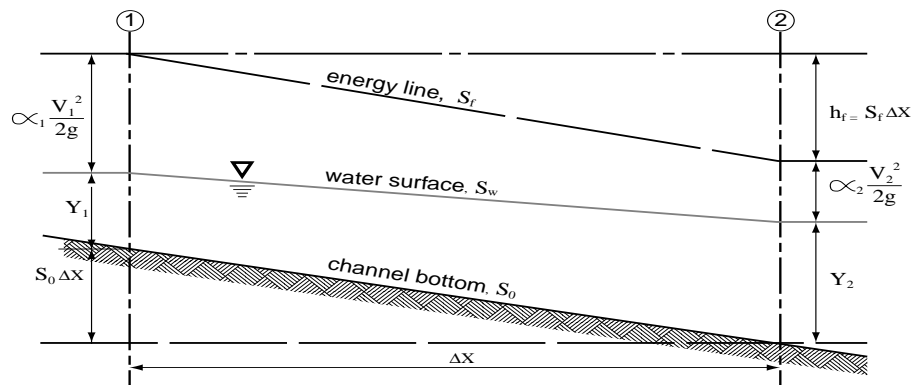
The Direct Step backwater method may be used to compute backwater profiles on prismatic channel reaches (i.e., reaches having uniform cross-section and slope) where a backwater condition or restriction to normal flow is known to exist. The method may be applied to a series of prismatic channel reaches in secession beginning at the downstream end of the channel and computing the profile upstream.

Calculating the coordinates of the water surface profile using this method is an iterative process achieved by choosing a range of flow depths, beginning at the downstream end, and proceeding incrementally up to the point of interest or to the point of normal flow depth. This is best accomplished by the use of a table (see Figure F.15 [and the accompanying example in Figure F.16](#)) or computer programs.

[Figure F.15 – Open Channel Flow Profile Computation.](#)

[Figure F.16 – Open Channel Flow Profile Computation \(Example\).](#)

To illustrate analysis of a single reach, consider the following diagram:



[Use Equation F-9 to calculate Equating](#) the total head at cross-sections 1 and 2, [the Equation F-9 may be written:](#)

[Equation F-9: Total head for a single reach \(Direct Step Analysis Method\)](#)

$$S_0 \Delta x + y_1 + \alpha_1 \frac{V_1^2}{2g} = y_2 + \alpha_2 \frac{V_2^2}{2g} + S_f \Delta x \quad (F-9)$$

where: Δx = distance between cross-sections (ft)
 y_1, y_2 = depth of flow (ft) at cross-sections 1 and 2

V_1, V_2	=	velocity (fps) at cross-sections 1 and 2
α_1, α_2	=	energy coefficient at cross-sections 1 and 2
S_o	=	bottom slope (ft/ft)
S_f	=	friction slope = $(n^2 V^2)/(2.21 R^{1.33})$
g	=	acceleration due to gravity, (32.2 ft/sec ²)

If the specific energy E at any one cross-section is defined [in Equation F-10 as follows:](#)

[Equation F-10: Specific energy for a single reach \(Direct Step Analysis Method\)](#)

$$E = y + \alpha \frac{V^2}{2g} \quad (\text{F-10})$$

and assuming $\alpha = \alpha_1 = \alpha_2$ where α is the energy coefficient that corrects for the non-uniform distribution of velocity over the channel cross-section, Equations F-9 and F-10 can be combined and rearranged to solve for Δx as shown in Equation F-11:

[Equation F-11: Distance between cross-sections \(Direct Step Analysis Method\)](#)

$$\Delta x = (E_2 - E_1)/(S_o - S_f) = \Delta E/(S_o - S_f) \quad (\text{F-11})$$

Typical values of the energy coefficient α are as follows:

Channels, regular section	1.15
Natural streams	1.3
Shallow vegetated flood fringes (includes channel)	1.75

For a given flow, channel slope, Manning's "n," and energy coefficient α , together with a beginning water surface elevation y_2 , the values of Δx may be calculated for arbitrarily chosen values of y_1 . The coordinates defining the water surface profile are obtained from the cumulative sum of Δx and corresponding values of y .

The normal flow depth, y_n , should first be calculated from Manning's equation to establish the upper limit of the backwater effect.

F.2.3.3 Standard Step Backwater Method

The Standard Step backwater method is a variation of the Direct Step backwater method and may be used to compute backwater profiles on both prismatic and non-prismatic channels. In this method, stations are established along the channel where cross-section data is known or has been determined through field survey. The computation is carried out in steps from station to station rather than throughout a given channel reach as is done in the Direct Step [backwater](#) method. As a result, the analysis involves significantly more trial-and-error calculation in order to determine the flow depth at each station.

Computer Applications

There are a number of commercial software programs for use on personal computers that use variations of the Standard Step backwater method for determining water surface profiles. The most common and widely accepted programs include HEC-RAS, published and supported by the United States (US) Army Corps of Engineers Hydraulic Engineering Center, and SWMM, originally published by US Environmental Protection Agency.

F.3 Riprap Design Standards

Design standards for riprap and riprap filter systems are presented below.

F.3.1 Riprap

Research by the US Army Corps of Engineers has provided criteria for selecting the median stone weight, W_{50} (see Figure F.17). If the riprap is to be used in a highly turbulent zone (such as at a culvert outfall, downstream of a stilling basin, at sharp changes in channel geometry, etc.), the median stone W_{50} should be increased from 200 percent to 600 percent depending on the severity of the locally high turbulence. The thickness of the riprap layer should generally be twice the median stone diameter (D_{50}) or at least that of the maximum stone. The riprap should have a reasonably well graded assortment of stone sizes within the following gradation:

$$1.25 \leq D_{max}/D_{50} \leq 1.50$$

$$D_{15}/D_{50} = 0.50$$

$$D_{min}/D_{50} = 0.25$$

Detailed design methodology may be found in [the Corps publication EM 1110-02-1601, Engineering and Design—Hydraulic Design of Flood Control Channels \(Army Corps 1991\)](#). For a more detailed analysis and design procedure for riprap requiring water surface profiles and estimates of tractive force, refer to [the paper by Maynard et al. in Journal of Hydraulic Engineering \(A.S.C.E.\), July \(1989\)](#).

Figure F.17 – Mean Channel Velocity vs. Medium Stone Weight and Equivalent Stone Diameter.

F.3.2 Riprap Filter Systems

Riprap should be underlain by a sand and gravel filter (or filter fabric) to keep the fine materials in the underlying channel bed from being washed through the voids in the riprap. Likewise, the filter material shall be selected so that it is not washed through the voids in the riprap. Adequate filters can usually be provided by a reasonably well graded sand and gravel material where:

$$D_{15} < 5 * d_{85}$$

The variable d_{85} refers to the sieve opening through which 85 percent of the material being protected will pass, and D_{15} has the same interpretation for the filter material. A filter material with a D_{50} of 0.5 mm will protect any finer material including clay. Where very large riprap is used, it is sometimes necessary to use two filter layers between the material being protected and the riprap.

Example

Problem:

What embedded riprap design should be used to protect a streambank at a level culvert outfall where the outfall velocities in the vicinity of the downstream toe are expected to be about 8 fps?

Solution:

From Figure F.17, $W_{50} = 6.5$ lbs, but since the downstream area below the outfall will be subjected to severe turbulence, increase W_{50} by 400 percent so that:

$$W_{50} = 26 \text{ lbs, } D_{50} = 8.0 \text{ inches}$$

The gradation of the riprap is shown in Figure F.16, and the minimum thickness would be 1 foot (from Table 4.5); however, 16 inches to 24 inches of riprap thickness would provide some additional insurance that the riprap will function properly in this highly turbulent area.

Figure F.18 shows that the gradation curve for ASTM C33, size number 57 coarse aggregate (used in concrete mixes), would meet the filter criteria. Applying the filter criteria to the coarse aggregate demonstrates that any underlying material whose gradation was coarser than that of a concrete sand would be protected.

[Figure F.18 – Riprap/Filter Example Gradation Curve.](#)

Appendix G – Subsurface Investigation and Infiltration Testing for Infiltration BMPs

Appendix G: Subsurface Investigation and Infiltration Testing for Infiltration BMPs

G.1 Roles and Responsibilities of Licensed Professionals

This appendix provides the minimum investigation requirements for infiltration Best Management Practices (BMPs). This information does not preclude the use of professional judgment to evaluate and manage risk associated with design, construction, and operation of infiltration BMPs.

Recommendations that deviate from the minimum investigation requirements specified in this appendix shall be contained in a stamped and signed letter from a State of Washington licensed professional engineer, engineering geologist, geologist, or hydrogeologist, herein referred to as licensed professional, who has experience in infiltration and groundwater testing and infiltration [facility-BMP](#) design, and must provide rationale and specific data supporting their professional judgment.

G.2 Subsurface Investigation

G.2.1 Description

Subsurface investigations consist of any type of excavation that allows for the collection of soil samples and the observation of subsurface materials and groundwater conditions, including hand-auger holes, test pits, and drilled boreholes.

This section includes general subsurface investigation requirements followed by specific information regarding four types of subsurface investigations:

- Simple subsurface investigation
- Standard subsurface investigation
- Comprehensive subsurface investigation
- Deep infiltration subsurface investigation

Underground Injection Control (UIC) wells ~~should~~[shall](#) demonstrate compliance with the UIC Program per [Volume I, Section 4.13 in the Ecology Manual](#).

G.2.2 General Subsurface Investigation Requirements

This section includes requirements for subsurface investigation locations, timing, alternatives, investigation depth and vertical separation requirements, and subsurface reports.

G.2.2.1 Subsurface Investigation Locations

Subsurface investigations shall be performed at the site of the infiltration [facility-BMP](#), unless demonstrated to be infeasible. In such case, the subsurface investigation shall be performed as close as possible, but no more than 50 feet away, to obtain relevant subsurface information. Subsurface investigations can be conducted at the same location as the infiltration tests ([Appendix G](#), Section Appendix :).

G.2.2.2 Subsurface Investigation Timing

Subsurface investigations should be performed in the wet season (November through March) if possible, when soils may contain a higher water content and groundwater levels are typically higher. Refer to [Appendix G](#), Sections Appendix : through 0 for wet season and dry season requirements for the different types of subsurface investigations.

G.2.2.3 Alternatives to Subsurface Investigation

In some cases, available data and the licensed professional's interpretation of subsurface material characteristics can be used to demonstrate that infiltration is infeasible on a site and precludes the need for all of the subsurface investigation or infiltration testing. Examples of these instances include, but are not limited to:

- Groundwater monitoring data that meets the requirements of the groundwater monitoring section ([Appendix G](#), Section Appendix :), at the site of the proposed [facility-BMP](#) showing groundwater elevations not meeting the vertical separation requirements ([Appendix G](#), Section 0).
- Identification by the licensed professional of hydraulically-restrictive materials beneath the proposed [facility-BMP](#) and within the vertical separation requirements ([Appendix G](#), Section 0).

To support these instances, the licensed professional must submit a stamped and signed letter that provides rationale and specific data supporting their professional judgment for each area deemed infeasible for infiltration.

G.2.2.4 Investigation Depth and Vertical Separation Requirements

Investigation depth is measured below the bottom of the proposed infiltration BMP. The bottom of the infiltration [facility-BMP](#) is defined as the deepest portion of the proposed [BMPfacility](#) where infiltrating water is expected to move into the underlying soil.

The vertical separation requirements depend upon the type of subsurface investigation required and the seasonal timing of the geotechnical exploration conducted to evaluate clearance and are typically 1 foot less than the minimum investigation depths summarized in [Appendix G](#), Sections Appendix : through 0. If groundwater or a hydraulically-restrictive material is encountered within the vertical separation depth, then no further investigation is required.

Examples of materials that may be interpreted as hydraulically-restrictive include:

- Glacially consolidated soils that have greater than 50 percent fines
- Glacially unconsolidated soils that have greater than 70 percent fines
- Bedrock

G.2.2.5 Subsurface Report

Projects that are required to perform subsurface investigations per [Volume II](#), Section 5.3 shall prepare a report documenting results of the subsurface investigations described in [Appendix G](#), Sections Appendix : through 0 and infiltration tests described in [Appendix G](#), Section Appendix :. Refer to report submittal requirements in Volume II, Chapter 1 [of this manual](#).

G.2.3 Simple Subsurface Investigation

Refer to Table 5.4 in [Volume II](#), Chapter 5 to determine the minimum subsurface investigation requirements for a project. The Simple Subsurface Investigation is conducted approximately 5 feet from the test hole.

A simple subsurface investigation report can be used to document the investigation and testing results. This report should include the following:

- Map of investigation and testing.
- Soil characteristics.
- Depth to groundwater (if encountered).

Table G.1. Simple Subsurface Investigation Elements

Minimum Investigation Depth and Vertical Separation Requirements			
All BMPs			
Season	Minimum Investigation Depth (feet) ^a	Minimum Vertical Separation, ft ^a	
		Groundwater	Hydraulically-Restrictive Layer
Wet Season (November – March)	2	1	1
Dry Season (April – October)	3	2	1
<u>Soil Characteristics</u> Type and texture of soil			

Notes:

^a The minimum investigation depth and vertical separation shall be measured from the bottom of the [facilityBMP](#). The bottom of the [facility-BMP](#) is defined as the deepest portion of proposed [facility-BMP](#) where infiltrating water is expected to move into the underlying soil.

G.2.4 Standard Subsurface Investigation

This section summarizes the minimum requirements of a Standard Subsurface Investigation. Refer to Table 5.4 in Volume II, Chapter 5 to determine the minimum subsurface investigation requirements for a project.

Table G-2. Standard Subsurface Investigation Elements

<u>Minimum Investigation Depth and Vertical Separation Requirements</u>			
Season	Minimum Investigation Depth (feet) ^a	Minimum Vertical Separation (feet) ^a	
		Groundwater	Hydraulically-Restrictive Layer
Infiltration Basins			
Wet Season (November – March)	6	5	5
Dry Season (April – October)	7	6	5
All Other Infiltration BMPs			
Wet Season (November – March)	2	1	1
Dry Season (April – October)	4	3	1
<u>Characterization for each soil and/or rock unit (strata with the same texture, color/mottling, density, and type)</u> <ul style="list-style-type: none"> • Unified Soil Classification System (USCS) classification or textural class • Material texture, color/mottling, density and type • Relative moisture content • Grain size distribution, including fines content determination • Presence of stratification or layering • Presence of groundwater • Iron oxide staining or mottling that may provide an indication of high-water level • Cation exchange capacity (refer to Volume V, Section 5.6 of the Ecology Manual) 			
<u>Detailed logs for each investigation</u> <ul style="list-style-type: none"> • Map showing the location of the test pits or borings • Depth of investigations • Investigation methods (hand augers, test pits, or drilled borings), material descriptions • Depth to water (if present) • Presence of stratification • Existing boring or groundwater information 			
<p>The report shall document how the information collected relates to the infiltration feasibility of the site based on the setbacks provided in Volume II, Section 5.3.2 and Appendix G. If more than 2,000 square feet of the site infiltration will occur within a single BMP, the Standard Subsurface Investigation report shall be prepared by a licensed professional in accordance with Volume II, Chapter 1.</p>			

Notes:

^a The minimum investigation depth and vertical separation shall be measured from the bottom of the BMP. The bottom of the BMP is defined as the deepest portion of proposed BMP where infiltrating water is expected to move into the underlying soil. For Small PITs, sampling of distinct materials below the bottom of the BMP and within the vertical separation depth is required. Beyond this depth, samples should be collected every 2.5 feet.

G.2.5 Comprehensive Subsurface Investigation

Refer to Table 5.4 in [Volume II](#), Chapter 5 to determine the minimum subsurface investigation requirements for a project. The comprehensive subsurface investigation report shall be prepared by a licensed professional. Refer to report submittal requirements in Volume II, Chapter 1 ~~of this manual~~.

Table G-3. Comprehensive Subsurface Investigation Elements

Minimum Investigation Depth and Vertical Separation Requirements			
Season	Minimum Investigation Depth (feet) ^{a, b}	Minimum Vertical Separation (feet) ^a	
		Groundwater	Hydraulically-Restrictive Layer
Infiltration Basins			
Wet Season (November – March)	6	5	5
Dry Season (April – October)	10	8	5
Permeable Pavement			
Wet Season (November – March)	2	1	1
Dry Season (April – October)	4	3	1
All Other Infiltration BMPs			
Wet Season (November – March)	4	3	3
Dry Season (April – October)	10	8	3
Characterization for each soil and/or rock unit (strata with the same texture, color/mottling, density, and type)			
Same as Standard Subsurface Investigation (Appendix G , Section Appendix :)			
Detailed logs for each investigation			
Same as Standard Subsurface Investigation (Appendix G , Section Appendix :)			

Notes:

- ^a The minimum investigation depth and vertical separation shall be measured from the bottom of the [facility-BMP](#). The bottom of the [facility-BMP](#) is defined as the deepest portion of proposed [facility-BMP](#) where infiltrating water is expected to move into the underlying soil. For Small PITs, sampling of distinct materials below the bottom of the [facility-BMP](#) and within the vertical separation depth is required. Beyond this depth, samples should be collected every 2.5 feet.
- ^b If the bottom of the [facility-BMP](#) is not known, the minimum investigation depth shall be 16 feet below grade. Investigations that will also serve as groundwater monitoring wells shall not be less than 20 feet below the bottom of proposed [facility-BMP](#) and the criteria for vertical separation to groundwater or hydraulically-restrictive materials listed above shall apply.

G2.6 Deep Infiltration Subsurface Investigation

Refer to Table [5-35.4](#) in [Volume II](#), Chapter 5 to determine the minimum subsurface investigation requirements for a project. The deep infiltration subsurface investigation report shall be prepared by a licensed professional. Refer to report submittal requirements in Volume II, Chapter 1 ~~of this manual~~.

Table G-4. Deep Infiltration Subsurface Investigation Elements

<p><u>Minimum Investigation Depth</u> At least 10 feet below regional groundwater table or into aquitard underlying target soil</p> <p><u>Characterization for each soil and/or rock unit (strata with the same texture, color/mottling, density, and type)</u> Same as Standard Subsurface Investigation (Appendix G, Section Appendix :)</p> <p><u>Detailed logs for each investigation</u> Same as Standard Subsurface Investigation (Appendix G, Section Appendix :)</p>
--

G.3 Determining the Measured (Initial) K_{sat} Infiltration Tests

G.3.1 Description

A crucial element of BMP design is the long term (design) infiltration rate of the native soils. In order to determine the design infiltration rate, the designer must first determine the measured (initial) saturated hydraulic conductivity (K_{sat}).

This section provides procedures for the following infiltration testing methods to determine the measured (initial) K_{sat} , as required in [Volume II](#), Section 5.3.2 in Volume II of this manual:

- Simple Infiltration Test (SIT)
- Small Pilot Infiltration Test (PIT)
- Large PIT
- Deep infiltration test
- Grain Size Analysis

To determine which infiltration test method is required for a project, refer to [Table 5-35.4](#) in [Volume II](#), Chapter 5.

If possible, perform infiltration testing at the location of the proposed infiltration [BMP facility](#). Infiltration testing results from a nearby location within 50 feet of the proposed infiltration [BMP facility](#) may be approved at the discretion of the licensed professional. If the infiltration testing is performed more than 50 feet from the final infiltration [BMP facility](#) location due to existing site conditions (e.g., existing structure at location of proposed [BMP facility](#)) and greater than 5,000 sf is infiltrated on the site, then acceptance testing is required (see refer to [Volume II](#), Section 5.3.2).

If variable soil conditions are observed at the site, multiple infiltration tests are recommended in the different soil types.

~~A simplified and detailed approach are presented to use the initial K_{sat} to determine the design infiltration rate of the native soils (Appendix G, Section G.4). The design infiltration rate is used to size the infiltration BMP, including verification of compliance with the maximum drawdown time of 48 hours. After the measured infiltration rates are determined using the procedures provided in this section, correction factors must be applied to calculate the design infiltration rate used for BMP sizing (refer to Section G.4).~~

The test method may be modified due to site conditions if recommended by the licensed professional and the reasoning is documented in the report. Any modifications to the proposed test method should be approved by Kitsap County.

G.3.2 Simple Infiltration Test (SIT)

The Simple Infiltration Test is a small-scale infiltration test procedure adapted from the ~~Washington State Department of Ecology (Ecology)~~ Rain Garden Handbook for Western Washington (Hinman et al. 2013 <https://fortress.wa.gov/ecy/publications/SummaryPages/1310027.html>).

The Simple Infiltration Test does not require a licensed ~~professional, and professional and~~ may only be applied for project sites located in rural areas, outside the UGA and UAs in accordance with Table [5.45-3 in Volume II, Chapter 5](#).

The Simple Infiltration Test is not allowed for projects with no offsite point of discharge. These projects shall use a Small PIT ([Appendix G](#), Section Appendix :).

Procedure

If testing is performed during the wet season (November through March), only one test is required. If the test is performed during the dry season (April through October), two tests must be performed in same hole within 2 days, with the beginning of each test spaced 24 hours apart.

1. Dig a hole a minimum of 2 feet deep. Preferably, the depth of the hole should be measured from the bottom of the ~~facility BMP~~ but at a minimum shall be measured from the proposed site finished grade. The hole shall be at least 2 feet in diameter.
2. Record the type and texture of the soil. If the soil is primarily fine-grained such as silt or clay, or is glacial till, infiltration may not be feasible.
3. At the same time that you dig your test hole, check for high groundwater by using a post hole digger to excavate a hole to the minimum subsurface investigation depth, as provided in [Appendix G](#), Section Appendix :, approximately 5 feet from the test hole. If standing water or seeping water is observed in the hole, measure the depth to the standing water or seepage.
4. Pre-soak period: Add 12 inches of water to the hole. This can be measured using a ruler, scale, or tape measure. Be careful to avoid splashing, which could erode the sides of the hole or disturb the soil at the base of the hole.
5. Record the depth of water in the hole in inches.
6. Record the time water was added to the hole.

7. Check and record the time and depth of water in the hole on an hourly basis for up to 2 hours. Estimate the infiltration rate in inches per hour by calculating the drop in water level in inches for each hour. Based on the lowest of these measurements, determine which time interval to use for the infiltration test by following these guidelines:
 - 3 inch per hour fall, check at 15-minute intervals.
 - 3 inch to 1 inch per hour fall, check at 30-minute intervals.
 - <1 inch per hour fall, check at hourly intervals.
8. Infiltration Test: Fill the hole back up to a depth of 12 inches. Check and record the time and depth of water in the hole at regular intervals based on the time interval determined during the presoak period for a total of six measurements. If the hole empties prior to the six measurements, refill and continue recording until you have recorded six measurements.
9. Calculate measured infiltration rate. Refer to Table [5.55-4](#) in [Volume II](#), Chapter 5 for minimum infiltration rates for each type of infiltration BMP. Using the collected data, estimate the measured infiltration rate in inches per hour by calculating the drop in water level in inches for each hour data was collected during the infiltration test. There should be a total of six values. The lowest calculated value is the measured infiltration rate in inches per hour
10. Mark test locations on site map.

G.3.3 Small Pilot Infiltration Test (Small PIT)

The testing procedure and data analysis requirements for the Small PIT are provided below. The report for this test shall include documentation of the testing procedure, analysis and results to assess infiltration feasibility and an explanation of the correction factor used to determine the design infiltration rate.

The Small PIT report shall be prepared by a licensed professional. The test method may be modified due to site conditions if recommended by the licensed professional and the reasoning is documented in the report. Refer to report submittal requirements in [Volume II, Chapter 1](#) of [this manual](#).

Procedure

1. Excavate the test pit to the depth of the bottom of the proposed infiltration [facility](#)[BMP](#). In the case of bioretention, excavate to the lowest estimated elevation at which the imported soil mix will contact the underlying soil. For permeable pavement, excavate to the elevation at which the imported subgrade materials, or the pavement itself, will contact the underlying soil. If the underlying soils (road subgrade) will be compacted, compact the underlying soils prior to testing. Note that the permeable pavement design guidance recommends compaction not exceed 90 to 92 percent.

2. Lay back the slopes sufficiently to avoid caving and erosion during the test. Alternatively, consider shoring the sides of the test pit.
3. The size of the bottom of the test pit ~~should be 12 to 32 square feet~~~~shall be a minimum of 12 square feet~~. Accurately document the size and geometry of the test pit.
4. Install a device capable of measuring the water level in the pit during the test. This may be a pressure transducer (automatic measurements) or a vertical measuring rod (minimum 5 feet long) marked in half-inch increments in the center of the pit bottom (manual measurements).
5. Use a rigid pipe with a splash plate or some other device on the bottom to convey water to the bottom of the pit and reduce side-wall erosion and excessive disturbance of the pit bottom. Excessive erosion and bottom disturbance may result in clogging of the infiltration receptor and yield lower than actual infiltration rates. The rigid pipe may be a 3-inch diameter pipe for pits on the smaller end of the recommended surface area, or a 4-inch pipe for pits on the larger end of the recommended surface area.
6. Pre-soak period: Add water to the pit so that there is standing water for at least 6 hours. Maintain the pre-soak water level at least 12 inches above the bottom of the pit.
7. Steady state period:
 - a. At the end of the pre-soak period, add water to the pit at a rate that will maintain a depth of 6–12 inches above the bottom of the pit over a full hour. A rotameter can be used to measure the flow rate into the pit. The depth should not exceed the proposed maximum depth of water expected in the completed BMP.
 - b. Every 15 minutes during the steady state period, record the cumulative volume and instantaneous flow rate (in gallons per minute) necessary to maintain the water level at the same point (between 6-inches and 1-foot)~~the design ponding depth~~ on the measuring rod or pressure transducer readout. The specific depth should be the same as the maximum designed ponding depth (usually 6-12 inches).
8. Falling head period: After 1 hour, turn off the water and record the rate of infiltration (the drop rate of the standing water) in inches per hour every 15 minutes using the pressure transducer or measuring rod data, for a minimum of 1 hour or until the pit is empty. A self-logging pressure sensor may also be used to determine water depth and drain-down.
9. At the conclusion of testing, over-excavate the pit to determine if the test water is mounded on shallow restrictive layers or if it has continued to flow deep into the subsurface. The depth of excavation varies depending on soil type and depth to the hydraulic restricting layer and is determined by the engineer or certified soils professional (refer to Table 5.4 in Volume II, Chapter 5). The soils professional should judge whether a mounding analysis is necessary. The investigation depth varies depending on the type of subsurface investigation required (refer to Table 5.3 in Chapter 5) and the seasonal timing of the geotechnical exploration conducted to evaluate

~~clearance.~~ Minimum investigation depths are provided in [Appendix G](#), Section Appendix
:.

Data Analysis

~~Calculate and record the initial K_{sat} rate in inches per hour in 30-minute or 1-hour increments until 1 hour after the flow has stabilized. Using the established steady state flow rate, calculate and record the measured infiltration rate in inches per hour. Use statistical/trend analysis to obtain the hourly flow rate when the flow stabilizes. This would be the lowest hourly flow rate. the falling head data to confirm the measured infiltration rate calculated from the steady state data.~~

Adjust the measured infiltration rate using the correction factor (CF) described in [Appendix G](#), Section Appendix : to estimate the design infiltration rate.

G.3.4 Large Pilot Infiltration Test (Large PIT)

A Large PIT will more closely simulate actual conditions for the infiltration ~~facility~~[BMP](#) than a Small PIT and may be preferred at the discretion of the licensed professional if not already required per Table [5.45-3](#) in [Volume II](#), Chapter 5. The testing procedure and data analysis requirements for the Large PIT are provided below. The report for this test shall include documentation of the testing procedure, analysis and results to assess infiltration feasibility and an explanation of the correction factor used to determine the design infiltration rate.

The Large PIT report shall be prepared by a licensed professional. The test method may be modified due to site conditions if recommended by the licensed professional and the reasoning is documented in the report. Refer to report submittal requirements in [Volume II](#), Chapter 1 ~~of this manual.~~

Procedure

- [1. Testing should occur between December 1 and April 1.](#)
- [2. The horizontal and vertical locations of the PIT shall be surveyed by a licensed land surveyor and accurately shown on the design drawings.](#)
- ~~10-3.~~ [Excavate the test pit to the depth of the bottom of the proposed infiltration facility](#)~~BMP into the native soil. Note that for some proposed BMPs, such as bioretention and permeable pavement, this will be below the finished grade. If native soils will have to meet the minimum subgrade compaction requirement (for example, the road subgrade using permeable pavement), compact the native soil to that requirement prior to testing.~~
- ~~11-4.~~ [Lay back the slopes sufficiently to avoid caving and erosion during the test. Alternatively, consider shoring the sides of the test pit.](#)
- ~~12-5.~~ [The size of the bottom of the test pit should be approximately 100 square feet, as close to the size of the planned infiltration facility as possible, but not less than 32 square feet in area \(100 square feet is recommended\).](#) Where water availability is an issue, smaller areas may be considered, as determined by the licensed professional. Accurately document the size and geometry of the test pit.

Refer to Steps 4 through ~~9~~40 as described in the Small PIT procedure ([Appendix G, Section G.3.3](#))~~above~~ with the following modifications:

- [Step 5: Use a rigid 6-inch diameter pipe with a splash plate.](#)
- [Step 7b: Data may be recorded every 15–30 minutes](#)
- [Step 7c: The flow rate should be maintained at a constant rate of 5 percent or less variation in the total flow while maintaining the same pond water level. The total of the pre-soak time plus 1 hour after the flow rate has stabilized should be no less than 6 hours.](#)
- [Step 8: After the flow rate has stabilized for at least 1 hour, turn off the water and record the rate of infiltration \(the drop rate of the standing water\) in inches per hour from the measuring rod data, until the pit is empty. Consider running this falling head phase of the test several times to estimate the dependency of infiltration rate with head.](#)
- [Step 9: Mounding is an indication that a mounding analysis is necessary.](#)

Data Analysis

Refer to the data analysis guidance for small PITs in [Appendix G, Section Appendix](#) .:

G.3.5 Deep Infiltration Test

The design infiltration rate for deep infiltration shall be determined by performing a constant-rate infiltration test followed by a falling-head infiltration test. The Deep Infiltration Test report shall include documentation of the testing procedure, analysis and results to assess infiltration feasibility and an explanation of the correction factor used to determine the design infiltration rate.

The Deep Infiltration Test report shall be prepared by a licensed professional. The test method may be modified due to site conditions if recommended by the licensed professional and the reasoning is documented in the report. Refer to report submittal requirements in Volume II, Chapter 1 [of this manual](#).

Procedure

1. Perform the test by adding water (obtained from a potable water source) to the test well to maintain a hydraulic head in the well equal to approximately half the thickness of the unsaturated infiltration receptor soil layer.
2. Monitor the flow rate with a flow meter or other method that is capable of measuring flow to within 5 percent of the total flow rate.
3. Monitor water levels in the test well with a pressure transducer and datalogger on a maximum of 5-minute intervals.

4. Add water until the rate of water added is constant, or for a minimum of 4 hours.
5. Once a constant rate is achieved, the test is complete. Begin the falling head portion of the test. Monitor water levels during the falling until the water level has fallen to a minimum of 5 percent of the total head targeted during the constant rate portion of the test.
6. In addition to the required wells, monitor groundwater elevations in nearby monitoring wells as available.

Data Analysis

The test data shall be evaluated by a licensed professional experienced in the analysis of well hydraulics and well testing data. As a result of the likely variability in soil conditions, specific methods for analysis of the data are not provided. It is the responsibility of the professional analyzing the data to select the appropriate methodology.

G.3.6 Grain Size Analysis

The design infiltration rate for grain size analysis shall be determined by a correlation to grain size distribution from soil samples. This method uses the ASTM soil size distribution test procedure (ASTM D422), which considers the full range of soil particle sizes, to develop soil size distribution curves. The following grain size analysis may be used to determine initial K_{sat} if the site has soils unconsolidated by glacial advance and is allowed for rural (outside the UA and UGA) residential project sites only. approved

The Grain Size Analysis report shall be prepared by a licensed professional. The test method may be modified due to site conditions if recommended by the licensed professional and the reasoning is documented in the report. Refer to report submittal requirements in Volume II, Chapter 1.

Procedure

1. For each defined layer below an infiltration pond to a depth below the pond bottom of 2.5 times the maximum depth of water in the pond, but not less than 10 feet, estimate the initial K_{sat} in cm/sec using Equation G-1. For large infiltration BMPs serving drainage areas of 10 acres or more, soil grain size analyses should be performed on layers up to 50 feet deep (or no more than 10 feet below the water table).

Equation G-1: Estimate Initial Saturated Hydraulic Conductivity

$$\log_{10}(K_{sat}) = -1.57 + 1.90D_{10} + 0.015D_{60} - 0.013D_{90} - 2.08f_{fines}$$

where:

K_{sat} = saturated hydraulic conductivity (cm/s) (1 cm/sec = 1417 in/hr)

D_{10} = grain size in mm for which 10 percent of the sample is more fine

D_{60} = grain size in mm for which 60 percent of the sample is more fine

D_{90} = grain size in mm for which 90 percent of the sample is more fine

f_{fines} = fraction of the soil (by weight) that passes the number-200 sieve

For BMP T7.30: Bioretention, analyze each defined layer below the top of the final bioretention area subgrade to a depth of at least 3 times the maximum ponding depth, but not less than 3 feet (1 meter).

For BMP T5.15: Permeable Pavements, analyze for each defined layer below the top of the final subgrade to a depth of at least 3 times the maximum ponding depth within the base course, but not less than 3 feet (1 meter).

If the licensed professional conducting the investigation determines that deeper layers will influence the rate of infiltration for the facility, soil layers at greater depths must be considered when assessing the site's initial K_{sat} . Massman (2003) indicates that where the water table is deep, soil or rock strata up to 100 feet below an infiltration BMP can influence the rate of infiltration. Note that only the layers near and above the water table or low permeability zone (e.g., a clay, dense glacial till, or rock layer) need to be considered, as the layers below the ground water table or low permeability zone do not significantly influence the rate of infiltration. Also note that this equation for estimating K_{sat} assumes minimal compaction consistent with the use of tracked (i.e., low to moderate ground pressure) excavation equipment.

If the soil layer being characterized has been exposed to heavy compaction (e.g., due to heavy equipment with narrow tracks, narrow tires, or large lugged, high pressure tires) the K_{sat} for the layer could be approximately an order of magnitude less than what would be estimated based on grain size characteristics alone. In such cases, compaction effects must be taken into account when estimating K_{sat} .

For clean, uniformly graded sands and gravels, the reduction in K_{sat} due to compaction will be much less than an order of magnitude. For well graded sands and gravels with moderate to high silt content, the reduction in K_{sat} will be close to an order of magnitude. For soils that contain clay, the reduction in K_{sat} could be greater than an order of magnitude.

If greater certainty is desired, the in-situ saturated hydraulic conductivity of a specific layer can be obtained through the use of a PIT, as described above.

2. Once the K_{sat} for each layer has been identified, determine the effective average K_{sat} of the native soils. K_{sat} estimates from different layers can be combined using the harmonic mean (Equation G-2).

Equation G-2: Saturated Hydraulic Conductivity Using the Harmonic Mean

$$K_{\text{equiv}} = \frac{d}{\sum \frac{d_i}{K_i}}$$

where:

d = total depth of the soil column.

d_i = thickness of layer "i" in the soil column

K_i = saturated hydraulic conductivity of layer "i" in the soil column

The depth of the soil column, d , typically would include all layers between the infiltration pond bottom and the water table. However, for sites with very deep water tables (>100 feet) where ground water mounding to the base of the infiltration pond is not likely to occur, it is recommended that the total depth of the soil column in Equation G-2 be limited to approximately 20 times the depth of infiltration pond, but not more than 50 feet. This is to ensure that the most important and relevant layers are included in the hydraulic conductivity calculations. Deep layers that are not likely to affect the infiltration rate near the infiltration pond bottom should not be included in Equation G-2.

Equation G-2 may over-estimate the effective K_{sat} value at sites with low conductivity layers immediately beneath the infiltration BMP. For sites where the lowest conductivity layer is within five feet of the base of the BMP, it is suggested that this lowest K_{sat} value be used as the equivalent hydraulic conductivity rather than the value from Equation G-2. Using the layer with the lowest K_{sat} is advised for designing bioretention (see Volume II, Section 5.4.6) and permeable pavement (see Volume II, Section 5.4.8). The harmonic mean given by Equation G-2 is the appropriate effective hydraulic conductivity for flow that is perpendicular to stratigraphic layers, and will produce conservative results when flow has a significant horizontal component such as could occur due to ground water mounding.

If using the soil Grain Size Analysis Method for estimating infiltration rates: Complete laboratory testing as necessary to establish the soil gradation characteristics and other properties, to complete the infiltration facility design. At a minimum, conduct one-grain size analysis per soil stratum in each test hole within 2.5 times the maximum design water depth, but not less than 10 feet. When assessing the hydraulic conductivity characteristics of the site, soil layers at greater depths must be considered if the licensed professional conducting the investigation determines that deeper layers will influence the rate of infiltration for the BMP, requiring soil gradation/classification testing for layers deeper than indicated above.

G.4 Infiltration Rate Correction Factor Calculation of Design Infiltration Rate of the Native Soils

G.4.1 The Simplified Approach to Calculating the Design Infiltration Rate of the Native Soils

The simplified approach was derived from high ground water and shallow pond sites in western Washington, and in general will produce conservative designs. This approach can be used when determining the trial geometry of the infiltration BMP and for small BMPs serving short plats or commercial developments less than 1 acre of contributing area. Designs of infiltration BMPs for larger projects should use the detailed approach (described below) and may have to

incorporate the results of a ground water mounding analysis as described in Appendix G, Section G.7. Note: A ground water mounding analysis is advisable for BMPs with drainage areas smaller than 1 acre if the depth to a low permeability layer (e.g., less than 0.1 inch per hour) is less than 10 feet.

Using the simplified approach, estimate the design (long-term) infiltration rate as follows:

- Use any of the options detailed in Appendix G, Section G.3 to estimate the initial K_{sat}
- Assume that the K_{sat} is the measured (initial) infiltration rate for the native soils
- Determine the design infiltration rate by adjusting the initial infiltration using the appropriate correction factors, as detailed below.

~~Measured infiltration rates described in Section G.3 shall be reduced using correction factors to determine the design infiltration rates. The determination of a design infiltration rate from in-situ infiltration test data involves a considerable amount of engineering judgment. Therefore, when determining the final design infiltration rate, the licensed professional shall consider the results of both soil subsurface material conditions and in-situ infiltration tests results. In no case shall the design infiltration rate exceed 10 inches per hour.~~

$$Design\ Infiltration\ Rate = Measured\ Infiltration\ Rate \times CF$$

A correction factor (CF) is applied to the measured infiltration rate to calculate the design infiltration rate. The design infiltration rate shall be used when sizing infiltration BMPs using the design criteria outlined in Volume II, Section 5.4 of this chapter.

Correction factors account for site variability, number of tests conducted, uncertainty of the test method, and the potential for long-term clogging due to siltation and bio-buildup. The specific correction factors used shall be determined based on the professional judgement of the licensed engineer in the state of Washington or other professional, considering all issues that may affect the infiltration rate over the long term, subject to the approval of Kitsap County.

Site variability and number of locations tested (CF_V)

The number of locations tested must be capable of producing a picture of the subsurface conditions that fully represents the conditions throughout the proposed location of the infiltration BMP. The partial correction factor used for this issue depends on the level of uncertainty that adverse subsurface conditions may occur. If the range of uncertainty is low—for example, conditions are known to be uniform through previous exploration and site geological factors—one pilot infiltration test may be adequate to justify a partial correction factor at the high end of the range.

If the level of uncertainty is high, a partial correction factor near the low end of the range may be appropriate. This might be the case where the site conditions are highly variable due to conditions such as a deposit of ancient landslide debris, or buried stream channels. In these cases, even with many explorations and several pilot infiltration tests, the level of uncertainty may still be high.

A partial correction factor near the low end of the range could be assigned where conditions have a more typical variability, but few explorations and only one pilot infiltration test is

conducted. That is, the number of explorations and tests conducted do not match the degree of site variability anticipated.

Uncertainty of test method (CF_t)

This criterion represents the accuracy of the infiltration test method used. Larger scale tests are assumed to produce more reliable results (i.e., the Large PIT is more certain than the Small PIT).

Degree of influent control to prevent siltation and bio-buildup (CF_m)

High uncertainty for this criterion may be justified under the following circumstances:

- If the infiltration BMP is located in a shady area where moss buildup or litter fall buildup from the surrounding vegetation is likely and cannot be easily controlled through long-term maintenance.
- If there is minimal pre-treatment, and the influent is likely to contain moderately high Total Suspended Solids (TSS) levels.
- If influent into the BMP can be well controlled such that the planned long-term maintenance can easily control siltation and biomass buildup, then low uncertainty may be justified for this criterion.

For design of bioretention and permeable pavement facilities, the design guidance provided in [Volume II, Section 5.4](#) shall be used to determine correction factors.

The overlying bioretention soil mix provides excellent protection for the underlying native soil from sedimentation. Accordingly, the correction factor for the sub-grade soil does not have to take into consideration the extent of influent control and clogging over time. The correction factor to be applied to in-situ, small-scale infiltration test results is determined by the number of tests in relation to the number of bioretention areas and site variability. Refer to [Table G-5 3.4.4 in the above referenced section of the Ecology Manual](#). Correction factors range from 0.33 to 1 (no correction) and are determined by the licensed professional that performed the infiltration testing.

Table G-5. Correction Factors to be Used with In-Situ Saturated Hydraulic Conductivity Measurements to Estimate Design Rates

<u>Issue</u>	<u>Partial Correction Factor</u>
<u>Site Variability and number of locations tested</u>	CF _v = 0.33 to 1.0
<u>Uncertainty of test method</u>	
<u>Simple Infiltration Test</u>	CF _t = 0.40
<u>Small-scale PIT</u>	= 0.50
<u>Large-scale PIT</u>	= 0.75
<u>Grain Size Method</u>	= 0.40
<u>Degree of influent control to prevent siltation and bio-buildup</u>	CF _m = 0.9

The Total Correction Factor shall then be calculated as follows:

$$\underline{CF_T = CF_V \times CF_t \times CF_m}$$

Simple Infiltration Test

~~A CF of 0.5 shall be applied to the measured infiltration rate to calculate the design infiltration rate.~~
The design infiltration rate (K_{sat} design) is calculated by multiplying the initial K_{sat} by the total correction factor:

$$\underline{K_{sat}design = K_{sat}initial \times CF_T}$$

G.4.2 The Detailed Approach to Calculating the Design Infiltration Rate of the Native Soils

For BMPs where the simplified approach is not applicable, refer to Volume V, Section 5.4 of the Ecology Manual for the detailed approach.

Small and Large PITs

A CF of 0.5 must be used for all projects unless a lower value is warranted by site conditions, as recommended and documented by a licensed professional, and shall not be less than 0.2. In determining an appropriate CF, the following criteria shall be considered and are described below:

- Site variability and number of locations tested.
- Uncertainty of test method.
- Degree of influent control to prevent siltation and bio-buildup.

Site variability and number of locations tested—This criterion depends on the level of uncertainty that adverse subsurface conditions may exist. The number of locations tested must be sufficient to represent the conditions throughout the facility site. If the subsurface conditions are known to be uniform based on previous exploration and site geological factors, one PIT may be adequate to justify that the uncertainty for that site is low.

Uncertainty of test method—This criterion represents the accuracy of the infiltration test method used. Larger scale tests are assumed to produce more reliable results (i.e., the Large PIT is more certain than the Small PIT).

Degree of influent control to prevent siltation and bio-buildup—High uncertainty for this criterion may be justified under the following circumstances:

- If the infiltration facility is located in a shady area where moss buildup or litter fall buildup from the surrounding vegetation is likely and cannot be easily controlled through long-term maintenance.
- If there is minimal pre-treatment, and the influent is likely to contain moderately high Total Suspended Solids (TSS) levels.
- If influent into the facility can be well controlled such that the planned long-term maintenance can easily control siltation and biomass buildup, then low uncertainty may be justified for this criterion.

G.5 Groundwater Monitoring

Groundwater monitoring wells (including the minimum subsurface investigation depth) shall be installed as determined in [Appendix G](#), Sections Appendix : through 0 under the direct supervision of a licensed professional. The minimum number of groundwater monitoring wells, duration of monitoring, and frequency of monitoring are summarized in Table [5.45-3](#) in

[Volume II](#), Chapter 5. A report shall be developed that is prepared by a licensed professional and includes a map detailing the locations of the monitoring wells relative to the project site and a description of the groundwater levels relative to the investigation depth and vertical separation requirements provided in [Appendix G](#), Section Appendix .: Refer to report submittal requirements in Volume II, Chapter 1 ~~of this manual~~.

Groundwater monitoring is not required in the following situations:

- Elevation data measured at project monitoring wells shows groundwater levels within the investigation depth and vertical separation requirements summarized in [Appendix G](#), Section Appendix .:
- Available groundwater elevation data within 50 feet of the proposed infiltration [facilityBMP](#) shows the highest measured groundwater level to be at least 10 feet below the bottom of the proposed infiltration [facilityBMP](#) or if the initial groundwater measurement is more than 15 feet below the bottom of the proposed infiltration [facilityBMP](#).

In these situations, no further investigation is required to meet onsite, flow control, or runoff treatment requirements. These exceptions do not apply to deep infiltration BMPs.

G.6 Characterization of Infiltration Receptor

The infiltration receptor is the unsaturated and saturated soil receiving stormwater from an infiltration [facilityBMP](#). Thresholds for triggering characterization of the infiltration receptor are summarized in Table [5.45-3](#) in [Volume II](#), Chapter 5.

Assessment and documentation by a licensed professional characterizing the infiltration receptor shall include the following elements:

- Depth to groundwater and to hydraulically-restrictive material.
- Seasonal variation of groundwater table based on well water levels and observed mottling of soils.
- Existing groundwater flow direction and gradient.
- Approximation of the lateral extent of infiltration receptor.
- Volumetric water holding capacity of the infiltration receptor soils. The volumetric water holding capacity is the storage volume in the soil layer directly below the infiltration [facilityBMP](#) and above the seasonal high groundwater mark, or hydraulically-restrictive material.
- Horizontal hydraulic conductivity of the saturated zone to assess the aquifer's ability to laterally transport the infiltrated water.

- [Impact of the infiltration rate and volume at the BMP site on groundwater mounding, flow direction, and water table; and discharge point or area of the infiltrating water. Conduct a groundwater mounding analysis at all sites where the depth to seasonal groundwater table or low permeability stratum is less than 15 feet from the estimated bottom elevation of the infiltration BMP, and the contributing basin to the infiltration BMP is more than 1 acre.](#)

Note: As part of the infiltration receptor characterization for deep infiltration wells, the pre-treatment requirements shall be evaluated [per Volume V, Section 5.3 in the Ecology Manualas in the ~~Guidance for Underground Injection Control Wells that Manage Stormwater~~ \(Ecology 2006\)](#).

G.7 Groundwater Mounding and Seepage Analysis

Infiltration of large volumes of water may result in a rise in the water table or development of a shallow water table on hydraulically-restrictive materials that slow the downward percolation of water. If this mounding of water is excessive, the infiltration [facilityBMP](#) may become less effective and/or adjacent structures or facilities may be impacted by the rising water table. In addition, if the infiltration [facilityBMP](#) is adjacent to a slope, slope stability may be decreased.

Thresholds for triggering groundwater mounding and seepage analysis are summarized in Table 5.4 of [Volume II, Chapter 5](#).

The mounding analysis shall evaluate the impact of the infiltration [facilityBMP](#) on local groundwater flow direction and water table elevations and determine whether there would be any adverse effects caused by seepage zones on nearby building foundations, basements, roads, parking lots or sloping sites. If the results of the mounding analysis indicate that adverse conditions could occur, as determined by a licensed professional, the infiltration [facilityBMP](#) shall not be built.

If infiltration on the site may result in shallow lateral flow (interflow), the conveyance and possible locations where that interflow may re-emerge should be assessed by a licensed hydrogeologist.

For deep infiltration BMPs, the following shall also be evaluated:

- Extent of groundwater mounding under the design flow rate.
- Potential impacts from the groundwater mounding to:
 - Deep infiltration BMP performance.
 - Surrounding infrastructure, including, but not limited to, infiltration [facilitiesBMPs](#), drainage facilities, foundations, basements, utility corridors, or retaining walls.
 - Offsite slope stability.
 - Down-gradient existing contamination plumes.

Several analytical tools are available to evaluate potential groundwater mounding beneath infiltration [facilitiesBMPs](#). These include both analytical and numerical groundwater flow software. In general, public domain software programs shall be used (such those initially authored by the United States Geological Survey (USGS) or the Environmental Protection Agency).

The software program MODRET is considered a standard tool for evaluating infiltration [BMPsfacilities](#), and is recommended in [the Ecology's Stormwater Management Manual for Western Washington](#). Although MODRET is a proprietary computer program, it is readily available for purchase and is based on USGS software. However, MODRET is limited to evaluation of a single [BMPfacility](#) at a time, and generally will not be suitable for evaluating clustered [facilitiesBMPs](#).

The preferred program for simulating groundwater mounding beneath infiltration [facilities-BMPs](#) is the USGS-based program MODFLOW. MODFLOW can be used to simulate a wide range of aquifer conditions and geometries. The primary limitation with MODFLOW is that most versions of the program do not simulate the movement of water through the unsaturated zone, which would normally be expected to slow the downward movement of water and allow for lateral spreading of water before reaching the water table. Instead, infiltrating water is input directly to the water table. For a shallow water table or perching layer this limitation should not greatly influence the overall results of the mounding simulation and represents a more conservative approach to simulating mounding.

Licensed hydrogeologists with formal training and experience in developing groundwater flow models should conduct these analyses. It should also be noted that groundwater models do not provide specific [answers, but answers but](#) are tools to help understand the behavior of groundwater systems under a variety of conditions. The results of any model should be used in the context of the overall goal of the project and be applied as warranted by the risk tolerance of the owner.

G.7.1 Data Requirements

Data requirements for development of a groundwater mounding model include:

- Soil and groundwater conditions.
- Aquifer parameters (e.g., hydraulic conductivity and specific yield).
- Aquifer geometry.
- Pre-infiltration hydraulic gradient.
- Flow rate from infiltration [facilitiesBMPs](#).

Many of the data inputs for the groundwater mounding model should be available in the vicinity of the infiltration [facilities-BMPs](#) from the subsurface investigation and infiltration testing performed for design of the [facilitiesBMPs](#). Outside the area of the infiltration [facilitiesBMPs](#), data may be sparse and may need to be interpolated from regional data. The extent of the

modeled area should be such that the edges of the model do not influence the data unless an actual boundary exists, such as Puget Sound.

In the absence of local information regarding the groundwater gradient and/or the distribution of hydraulic restrictive layers, mounding analyses should consider the general slope of the site and surrounding sites, as the general slope is likely indicative of the direction of interflow originating from infiltration [facilities-BMPs](#) and the regional hydraulic gradient.

Aquifer parameters shall be estimated based on knowledge of local soil types and from grain size distribution of the soil samples collected as part of the subsurface investigation and testing program. In general, groundwater flow models tend to be most sensitive to variations in hydraulic conductivity values. Obtain hydraulic conductivity values from field testing of the infiltration receptor soils using standard industry methods.

G.7.2 Analysis Procedures

The initial step for any groundwater modeling analysis is the development of a conceptual model of the groundwater system. The conceptual model should describe the anticipated groundwater flow system including the data requirements described above, direction and rate of groundwater flow, potential model boundaries, and approach for simulating infiltration. The conceptual model provides the basis for constructing the computer model.

Because of the limited available data necessary for model inputs, a parametric analysis shall be performed whereby model inputs, especially aquifer parameters, are varied over a range of values to evaluate the potential impact on the mounding results. The range values shall be based on known variability in the parameter and experience with similar soils in the area by the licensed professional developing the model.

The following ranges of aquifer parameters shall be used in the parametric analysis:

- Hydraulic conductivity: one order of magnitude (e.g., + and - a power of 10) for each receptor soil.
- Aquifer thickness: plus or minus 50 percent of the known values.
- Specific yield: minimum range of 0.05 to 0.2.

If known field conditions warrant, increase the above ranges as necessary.

In general, multiple infiltration scenarios will need to be simulated to evaluate potential mounding below the infiltration [BMPsfacilities](#). For example, both short-term peak storm events and long-term seasonal precipitation should be evaluated. Additional scenarios may include a series of short-term high precipitation events. Although the actual events that need to be simulated will depend on subsurface conditions, number and types of infiltration [facilitiesBMPs](#), and potential risk factors, as a minimum the following scenario is required:

- A typical wet season (November through April) based on average monthly precipitation followed by a single-event rainfall modeling of the back-loaded long-duration storm for the 100-year recurrence interval, using data from the closest rain gage.

The licensed hydrogeologist performing the mounding analysis should use professional judgment and experience to potentially modify the above scenario or add additional scenarios on a project specific basis, as needed.

As additional soil and groundwater information is collected during construction, testing, and operation of the infiltration [facilityBMP](#), the mounding analysis should be revised and refined to incorporate any new information. If groundwater monitoring indicates results inconsistent with the findings of the mounding analysis, in the opinion of a licensed hydrogeologist, the model should be re-evaluated. The re-evaluation should include simulation of the precipitation events prior to the observed groundwater monitoring data.

Appendix H – LID BMP Infeasibility Criteria

Appendix H: LID BMP Infeasibility Criteria

Table H.1 – Onsite Requirement Infeasibility Criteria Checklist: All Dispersion BMPs and All Infiltration BMPs.

BMP	Infeasibility Criteria	Additional Information from Applicant
All Dispersion BMPs	<ul style="list-style-type: none"> • Where A licensed professional geotechnical evaluation recommends dispersion not be used anywhere within project site due to reasonable concerns of erosion, slope failure, or flooding (requires a signed and stamped written determination based on site-specific conditions from an appropriately licensed professional). • The dispersion flow path does not provide positive drainage. • Only available dispersion flow path area is within an erosion hazard or a landslide hazard area (Title 19 KCC). • Only available dispersion flow path area is in or within 100 feet up-gradient of a known contaminated site or abandoned landfill (active or closed). • Only available dispersion flow path area is in a critical area (Title 19 KCC), steep slope (as defined in Section 5.3.1) >15%), or on or above slopes greater than 20%, or above erosion hazard areas setback to steep slope (calculated as 10 times the height of the steep slope to a 500-foot maximum setback). • Only available dispersion flow path area is within the minimum horizontal setback requirements between stormwater control device and onsite sewage system components per Table 5.2 up-gradient and within 10 feet of proposed or existing septic system or drain field. 	
All Infiltration BMPs	<p>The following criteria each establish that the BMP is infeasible but only if based on an evaluation of site-specific conditions and documented within a signed and stamped written determination from an appropriately licensed professional (e.g., engineer, geologist, hydrogeologist):</p> <ul style="list-style-type: none"> • Where professional geotechnical evaluation infiltration is not recommended recommends infiltration not be used due to reasonable concerns about erosion, slope failure, or flooding. • Where the only area available for siting would threaten the safety or reliability of pre-existing underground utilities, pre-existing underground storage tanks, pre-existing structures, or pre-existing road or parking lot surfaces or subgrades. • Where the only area available for siting does not allow for a safe overflow pathway. 	

BMP	Infeasibility Criteria	Additional Information from Applicant
	<ul style="list-style-type: none"> • Where The area available for siting infiltrating water would threaten shoreline structures such as bulkheads. <p>The following criteria each establish that the BMP is infeasible, without further justification, though some criteria require professional services:</p> <ul style="list-style-type: none"> • TWhere the horizontal setback criteria listed in Volume II, Section 5.3.2 cannot be met. Note: For most infiltration BMPs, setbacks are measured from the vertical extent of maximum ponding before overflow. For bioretention and rain gardens, setback distances are as measured from the bottom edge of the bioretention or rain garden soil mix (i.e., bioretention cell bottom at the toe of the side slope). • TWhere the following minimum vertical separation to the seasonal high water table or hydraulically-restrictive layer would not be achieved below the infiltration BMP: <ul style="list-style-type: none"> ○ 1-foot separation for a BMP that would serve a drainage area that is: 1) less than 5,000 square feet of pollution-generating hard surface (PGHS), and 2) less than 10,000 square feet of impervious surface; and, 3) less than three-quarter (3/4) acres of pervious surface. This clearance also applies to permeable pavement facilities regardless of size. Vertical separation requirements are larger if explorations are conducted during the dry season (seerefer to Volume II, Section 5.3.2). ○ 3-foot separation for a BMP that would serve a drainage area that meets or exceeds: <ul style="list-style-type: none"> 1) 5,000 square feet of PGHS, or 2) 10,000 square feet of impervious surface, or 3) three-quarter (3/4) acres of pervious surfaces. To use the 3-foot separation criterion, it must be demonstrated that the drainage areas cannot reasonably be broken down into amounts smaller than the drainage thresholds listed above. Vertical separation requirements are larger if explorations are conducted during the dry season (seerefer to Volume II, Section 5.3.2). • Site-specific infiltration rates are below minimum allowable rates in Table 5.5. • The area available for siting is within a steep slope area or landslide prone area (or setback) (see Volume II, Section 5.3.2) • The only area available for siting does not allow for a safe overflow pathway. 	

BMP	Infeasibility Criteria	Additional Information from Applicant
	<ul style="list-style-type: none"> Infiltration is restricted due to known contaminated soil or groundwater 	

Table H.2 – Onsite Requirement Infeasibility Checklist.

BMP	Infeasibility Criteria	Additional Information from Applicant
Post Construction Soil Quality and Depth	<ul style="list-style-type: none"> Portions of the site comprised of till soils with slopes greater than 33% can be considered infeasible for this BMP. 	
Full Dispersion	<ul style="list-style-type: none"> One or more of tThe infeasibility criteria for “All Dispersion BMPs” (Appendix H, Table H.1) apply. The design criteria for full dispersion (Volume II, Section 5.4.4) cannot be met. The dispersion area cannot meet the requirement to have a minimum area 6.5 times the area of the impervious surface draining to it. A 65 to 10 ratio of the native vegetation area to the impervious area is unachievable. Minimum dispersion flow path area and length requirements per Table 5.1 are unachievable. A minimum native vegetation flow path length of 100 feet (25 feet for sheet flow from a non-native pervious surface) is unachievable. 	
Downspout Dispersion	<ul style="list-style-type: none"> One or more of tThe infeasibility criteria for “All Dispersion BMPs” (Appendix H, Table H.1) apply. The design criteria for splashblock or trench downspout dispersion (Volume II, Section 5.4.4) cannot be met. There are no downspouts. The flow path setbacks to property lines, structures and other flow paths (Volume II, Section 5.4.4) cannot be achieved. <p>Splashblock Dispersion</p> <ul style="list-style-type: none"> The vegetated flow path is less than 50 feet. Greater than 700 square feet of surface area drains to the BMP. The flow path does not meet the minimum horizontal setback requirements to property lines, structures, and other flow paths (Volume II, Section 5.4.4). A minimum 10 foot length of dispersion trench for every 700 square feet of drainage area followed by 25 foot minimum flow path is unachievable. 	

BMP	Infeasibility Criteria	Additional Information from Applicant
	<ul style="list-style-type: none"> • A 50-foot minimum flow path for the dispersion area or a maximum of 700 square feet of drainage area to any splashblock is unachievable. <p>Trench Dispersion</p> <ul style="list-style-type: none"> • The minimum dispersion trench length of 10 feet for every 700 square foot of drainage area cannot be met. • The vegetated flow path is less than 25 feet. • The flow path is within the setbacks to property lines, structures, and other flow paths (Volume II, Section 5.4.4) • A 50-foot minimum flow path for the dispersion area or a maximum of 700 square feet of drainage area to any splashblock is unachievable. 	
Sheet Flow Dispersion	<ul style="list-style-type: none"> • One or more of the infeasibility criteria for “All Dispersion BMPs” (Appendix H, Table H.1) apply. • The design criteria for sheet flow dispersion (Volume II, Section 5.4.4) cannot be met. • Positive drainage for sheet flow runoff is unachievable. • Area to be dispersed (e.g., driveway, patio) cannot be graded to have less than a 15% slope. • The flow path does not meet the minimum horizontal setbacks to property lines, structures, and other flow paths (see refer to Volume II, Section 5.4.4). cannot be achieved. 	
Concentrated Flow Dispersion	<ul style="list-style-type: none"> • One or more of the infeasibility criteria for “All Dispersion BMPs” (Appendix H, Table H.1) apply. • The design criteria for concentrated flow dispersion (Volume II, Section 5.4.4) cannot be met. • There are no concentrated flows to disperse. • The dispersion device and flow path requirements are unachievable: <ul style="list-style-type: none"> ○ A minimum 10-foot length of dispersion trench followed by a 25-foot minimum flow path or a rock pad with a 50-foot minimum flow path. ○ A maximum of 700 square feet of drainage area to any dispersion device. • The flow path does not meet the minimum horizontal setbacks to property lines, structures, and other flow paths (see refer to Volume II, Section 5.4.4). cannot be achieved. 	
Bioretention	<ul style="list-style-type: none"> • The design criteria for bioretention (Volume II, Section 5.4.6) cannot be met. • Refer to the additional bioretention Infeasibility Criteria in the BMP T7.30 of the Ecology Manual. Ecology Manual, Volume V, Chapter 7. 	

BMP	Infeasibility Criteria	Additional Information from Applicant
Rain Garden	<ul style="list-style-type: none"> The design criteria for rain gardens (Volume II, Section 5.4.45) cannot be met. Refer to the additional rain garden Infeasibility Criteria in the Ecology Manual, Volume V, Chapter 7. 	
Perforated Stub-out Connection	<ul style="list-style-type: none"> <u>One or more of the</u> infeasibility criteria for “All Infiltration BMPs” (<u>Appendix H, Table H.1</u>) apply. The design criteria for perforated stub-out connections (Volume II, Section 5.4.7) cannot be met. The only location for the perforated pipe portion of the system is under impervious or heavily compacted (e.g., driveways and parking areas) surfaces. A minimum of 10 feet of perforated pipe per 5,000 square feet of contributing roof area is unachievable. <u>The seasonal water table is less than 1 foot below the trench bottom.</u> <u>The site cannot be reasonably designed to locate a catch basin between the perforated stub-out and point of connection to the public system.</u> 	
Permeable Pavement	<ul style="list-style-type: none"> <u>The Design Criteria for Permeable Pavement (Volume II, Section Ch. 5.4.8) cannot be met.</u> <u>Refer to additional permeable pavement Infeasibility Criteria in BMP T5.15 of the Ecology Manual.</u> Note that the infeasibility criteria for “All Infiltration BMPs” are not applicable and the minimum native soil infiltration rate differs, as described <u>in BMP T5.15 of the Ecology Manual</u> below). <p><u>The following criteria each establish that the BMP is infeasible but only if based on an evaluation of site-specific conditions and a written recommendation from an appropriate licensed professional (e.g., engineer, geologist, hydrogeologist):</u></p> <p><u>Where infiltrating and ponded water below permeable pavement area would compromise adjacent impervious pavements:</u></p> <ul style="list-style-type: none"> <u>Where fill soils are used that can become unstable when saturated.</u> <u>Where permeable pavements cannot provide sufficient strength to support heavy loads in areas with “industrial activity” as identified in 40 CFR 122.26(b)(14).</u> <u>Excessively steep slopes where water within the aggregate base layer or at the sub-grade surface cannot be controlled by detention structures and may cause erosion and structural failure, or where surface runoff velocities may preclude adequate infiltration at the pavement surface.</u> 	

BMP	Infeasibility Criteria	Additional Information from Applicant
	<p>The following criteria each establish that the BMP is infeasible, without further justification, though some criteria require professional services:</p> <ul style="list-style-type: none"> ● Where subgrade slopes exceed 5%. ● Within 50 feet from the top of slopes that are steeper than 20% gradient. ● At multi-level parking garages, and over culverts and bridges. ● For properties with known soil or ground water contamination (typically federal Superfund sites or state cleanup sites under the Model Toxics Control Act (MTCA)): <ul style="list-style-type: none"> ● Within 100 feet of an area known to have deep soil contamination; ● Where ground water modeling indicates infiltration will likely increase or change the direction of the migration of pollutants in the ground water; <ul style="list-style-type: none"> ○ Wherever surface soils have been found to be contaminated unless those soils are removed within 10 horizontal feet from the infiltration area; ○ Any area where these facilities are prohibited by an approved cleanup plan under the state Model Toxics Control Act or Federal Superfund Law, or an environmental covenant under. ○ Where the site design cannot avoid putting pavement in areas likely to have long-term excessive sediment deposition after construction (e.g., construction and landscaping material yards).* ○ Where the site cannot reasonably be designed to have a porous asphalt surface at less than 5% slope, or a pervious concrete surface at less than 40% slope, or a permeable interlocking concrete pavement surface (where appropriate) at less than 12% slope. Note: grid systems upper slope limit can range from 6 to 12%; check with manufacturer and local supplier. ○ Where the native soils below a pollution-generating permeable pavement (e.g., road or parking lot) do not meet the soil suitability criteria for providing treatment. Refer to the Ecology Manual, Chapter 3 of Volume III. ○ Where underlying soils are unsuitable for supporting traffic loads when saturated. Soils meeting a California Bearing Ratio of 5% are considered suitable for residential access roads. ○ Where field testing indicates soils have a measured (a.k.a., initial) native soil infiltration rate 	

BMP	Infeasibility Criteria	Additional Information from Applicant
	<p>less than 0.3 inches per hour, permeable pavement facilities without underdrains are not considered feasible.</p> <ul style="list-style-type: none"> ○ Where road has ADT exceeding 400 vehicles per day (very low volume road) or exceeding very low truck traffic. Areas with very low truck traffic volumes are roads and other areas not subject to through truck traffic but may receive up to weekly use by utility trucks (e.g., garbage, recycling), daily school bus use, and multiple daily use by pick-up trucks, mail/parcel delivery trucks, and maintenance vehicles. ● Where replacing existing impervious surfaces unless the existing surface is a non-pollution-generating surface over an outwash soil with an infiltration rate of four inches per hour or greater. ● At sites defined as “high use sites” in Volume I, Appendix A. ● In areas with “industrial activity” as identified in *. ● Where the risk of concentrated pollutant spills is more likely, including, but not limited to, gas stations, truck stops, and industrial chemical storage sites.* ● Where routine, heavy applications of sand occur in frequent snow zones to maintain traction during weeks of snow and ice accumulation.* ● * These criteria also apply to impervious pavements that would employ stormwater collection from the surface of impervious pavement with redistribution below the pavement. ● Where it is infeasible to prevent stormwater run-on to the permeable pavement from unstabilized, erodible areas without adequate pre-settling to prevent clogging of the permeable pavement surface. ● Where field testing indicates soils have a measured (a.k.a., initial) native soil infiltration rate less than 0.3 inches per hour permeable pavement are not considered feasible. (Note: field infiltration tests are not required, but may be used to demonstrate infeasibility). ● Where the site is a contaminated site or abandoned landfill. ● Within 10 feet of an underground storage tank or connecting underground pipes. (Applicable to tanks used to store petroleum products, chemicals, or liquid hazardous wastes). ● Where professional geotechnical evaluation recommends permeable pavement not be used anywhere within the project site due to reasonable concerns of erosion, slope failure, or flooding 	

BMP	Infeasibility Criteria	Additional Information from Applicant
	(requires a signed and stamped written determination based on site specific conditions from an appropriately licensed professional).	
Tree Retention and Tree Planting	<ul style="list-style-type: none"> • Space necessary for the mature height, size, and/or rooting depth for tree planting per Title 17 KCC is unachievable. • No existing trees with diameter equal to or greater than 6-inches diameter at breast height (DBH) on project site. DBH is defined as the outside bark diameter at 4.5 feet above the ground on the uphill side of a tree. • New and/or replaced ground level impervious surface not proposed within 20 feet of existing tree. • For tree(s) with a diameter greater than or equal to 6 inches, significant grading is unavoidable within the dripline. • For tree(s) with a diameter of 4–6 inches, significant grading is unavoidable within 5 feet of tree trunk. • Trees are considered danger trees according to KCC Section 19.150.230. 	

References

References

- ~~AHBL and HDR. *Eastern Washington Low Impact Development Guidance Manual*. Prepared for Washington State Department of Ecology. June 2013.~~
- ~~Army Corps. 1991. *Hydraulic Design of Flood Control Channels*. EM 1110-2-1601. Prepared by the United States Army Corps of Engineers. July.~~
- ~~Chow, V.T. 1959. *Open Channel Hydraulics*. McGraw Hill Book Company, Inc.~~
- EPA. Section 519 of the United States Federal Water Pollution Control Act (commonly referred to as Clean Water Act of 1977). 33 United States Code §1251 et seq.
- ~~Florida Department of Agriculture and Consumer Services (FDACS). 2014. *Water Quality/Quantity Best Management Practices for Florida Nurseries*. DACS-P-1267. April.~~
- ~~FHWA. 2012. *Hydraulic Design of Highway Culverts*. Hydraulic Design Series No. 5, Third Edition. FHWA-HIF-12-026. Prepared by the United States Department of Transportation Federal Highway Administration. April.~~
- ~~FHWA. 2006. *Hydraulic Design of Energy Dissipators for Culverts and Channels*. Hydraulic Engineering Circular No. 14, Third Edition. FHWA-NHI-06-086. Prepared by the United States Department of Transportation Federal Highway Administration. July.~~
- ~~Haver, D. 2014. *Best Management Practices: A Water Quality Field Guide for Nurseries, Southern California Edition*. The Regents of the University of California.~~
- ~~Herrera and WSC. *Washington State Department of Ecology (Ecology). Western Washington Low Impact Development (LID) Operations and Maintenance Manual (O&M)*, Prepared for the Washington State Department of Ecology by Herrera Environmental Consultants and the Washington Stormwater Center. May.~~
- ~~Hinman, C., Washington State Department of Ecology, Washington State University Extension, and Kitsap County. *Rain Garden Handbook for Western Washington: A Guide for Design, Installation, and Maintenance*. June.~~
- ~~Hinman, C. and B. Wulkan. *Puget Sound Partnership and WSU Extension. Low Impact Development Technical Guidance Manual for Puget Sound*, Washington State University Extension and Puget Sound Partnership. December.~~
- ~~Kitsap County. Resolution ~~134-2016-109-2009~~ “Reaffirming Kitsap County’s Water as a Resource” Policy. August 2016. Accessed at www.kitsapgov.com/dcd/PEP%20Documents/Water%20Policy%20Update%20134-2016.pdf#search=134%2D2016 http://www.kitsapgov.com/sswm/pdf/Water_resource_policy.pdf on September 28, 2015.~~
- ~~Kitsap Home Builders. 2009. *Low Impact Development (LID) Guidance Manual. A Practical Guide to LID Implementation in Kitsap County. Version 1.2*. Published by the Kitsap Home Builders Association and prepared by O’Brien & Company. June.~~

[Massman, J. 2003. *A Design Manual for Sizing Infiltration Ponds*. Washington State Department of Transportation. October.](#)

[Maynard, S.T., J.F. Ruff, and S.R. Abt. 1989. Riprap Design. *Journal of Hydraulic Engineering \(American Society of Civil Engineers\)*. 115: 7. July.](#)

[Peterka, A.J. 1984. *Hydraulic Design of Stilling Basins and Energy Dissipators*. Engineering Monograph No. 25. Prepared by the United State Department of the Interior Bureau of Reclamation. May.](#)

Washington State Department of Ecology (Ecology). [2019. *Stormwater Management Manual for Western Washington, Volumes I—V, Final*, July Amended December 2014.](#)

Washington State Department of Ecology (Ecology). [2019. *Western Washington Phase II Municipal Stormwater Permit; National Pollutant Discharge Elimination System and State Waste Discharge General Permit for discharges from Small Municipal Separate Storm Sewers in Western Washington*. Issued July 1, 2019 August 1, 2012, Effective August 1, 2019 2013, Expires July 31, 2024 2018, Modified January 16, 2014.](#)

[Washington State Department of Ecology \(Ecology\). 2018. *Technical Guidance Manual for Evaluating Emerging Stormwater Treatment Technologies*. September 2018.](#)

[Washington State Department of Ecology \(Ecology\). 2012. *Vehicle and Equipment Washwater Discharges Best Management Practices Manual*. Publication Number WQ-R-95-056. Water Quality Program. November.](#)

WSDOT. 2019. Highway Runoff Manual, Washington State Department of Transportation. April 2014.

[WSDOT. 2019. *Hydraulics Manual*. Design Office, Engineering and Regional Operations Division, Washington State Department of Transportation, Olympia, Washington. Publication No. M 23-03. April.](#)

[WSDOT. 2020. *2020 Standard Specifications for Road, Bridge, and Municipal Construction*. Washington State Department of Transportation. Publication Number M 41-10. Olympia, Washington.](#)

Volume I Figures

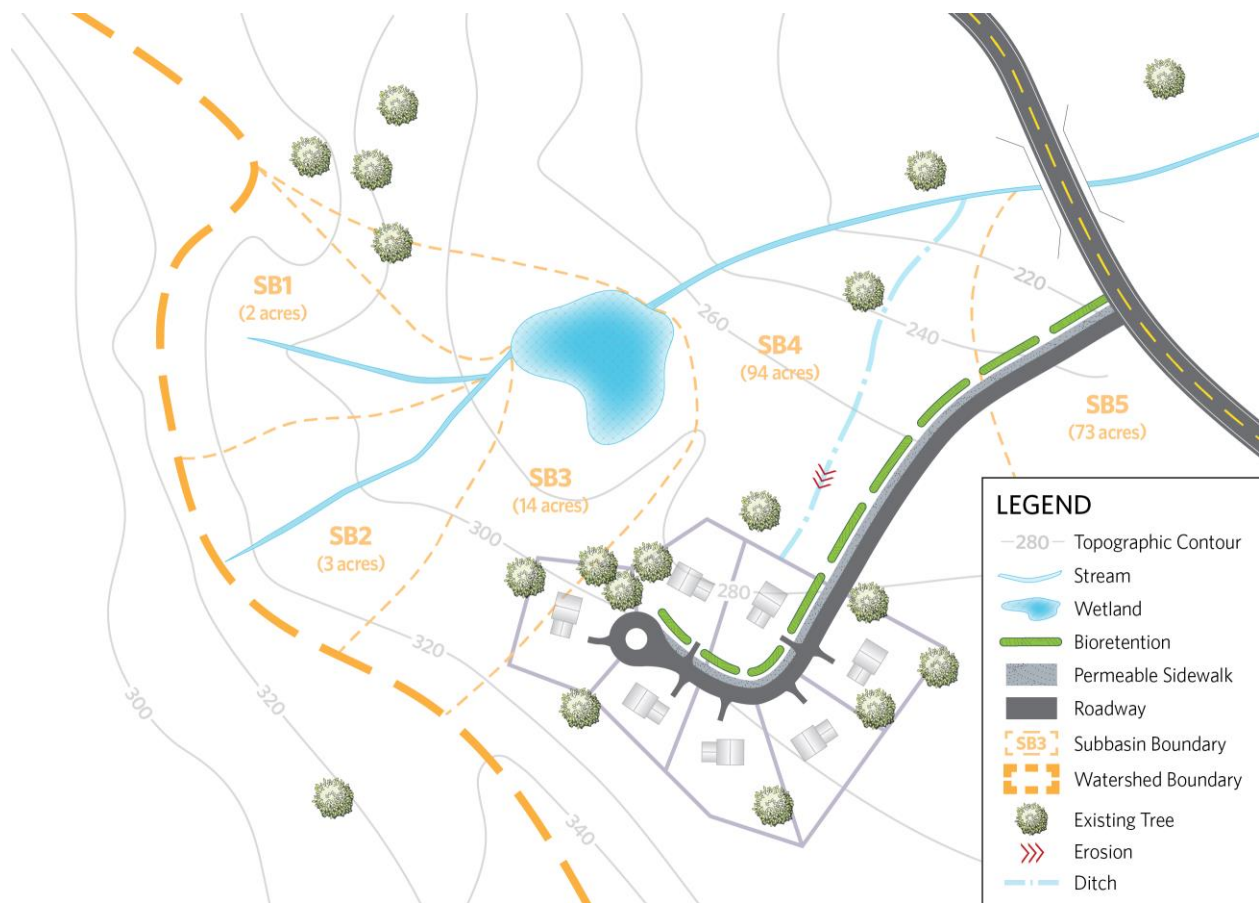


Figure 2.1
 Example Map Documenting
 Existing Hydrologic Features



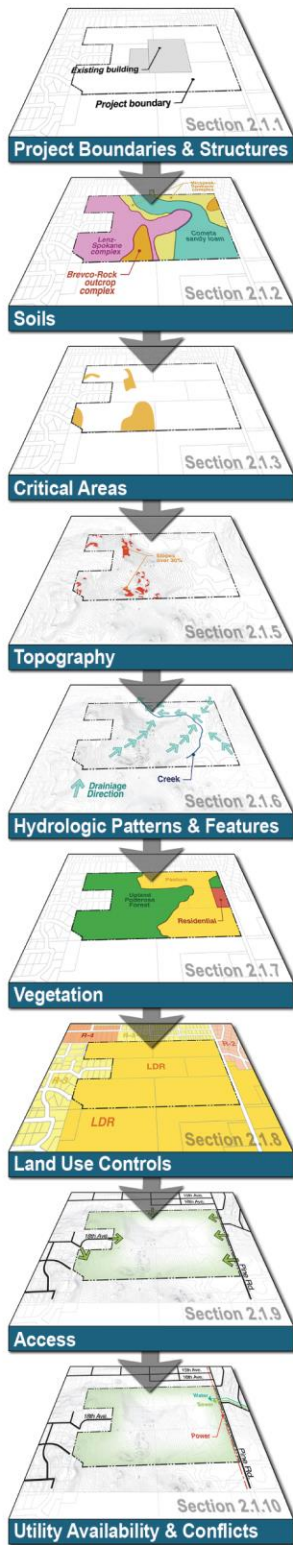


Figure 2.2
Example Composite Site Map

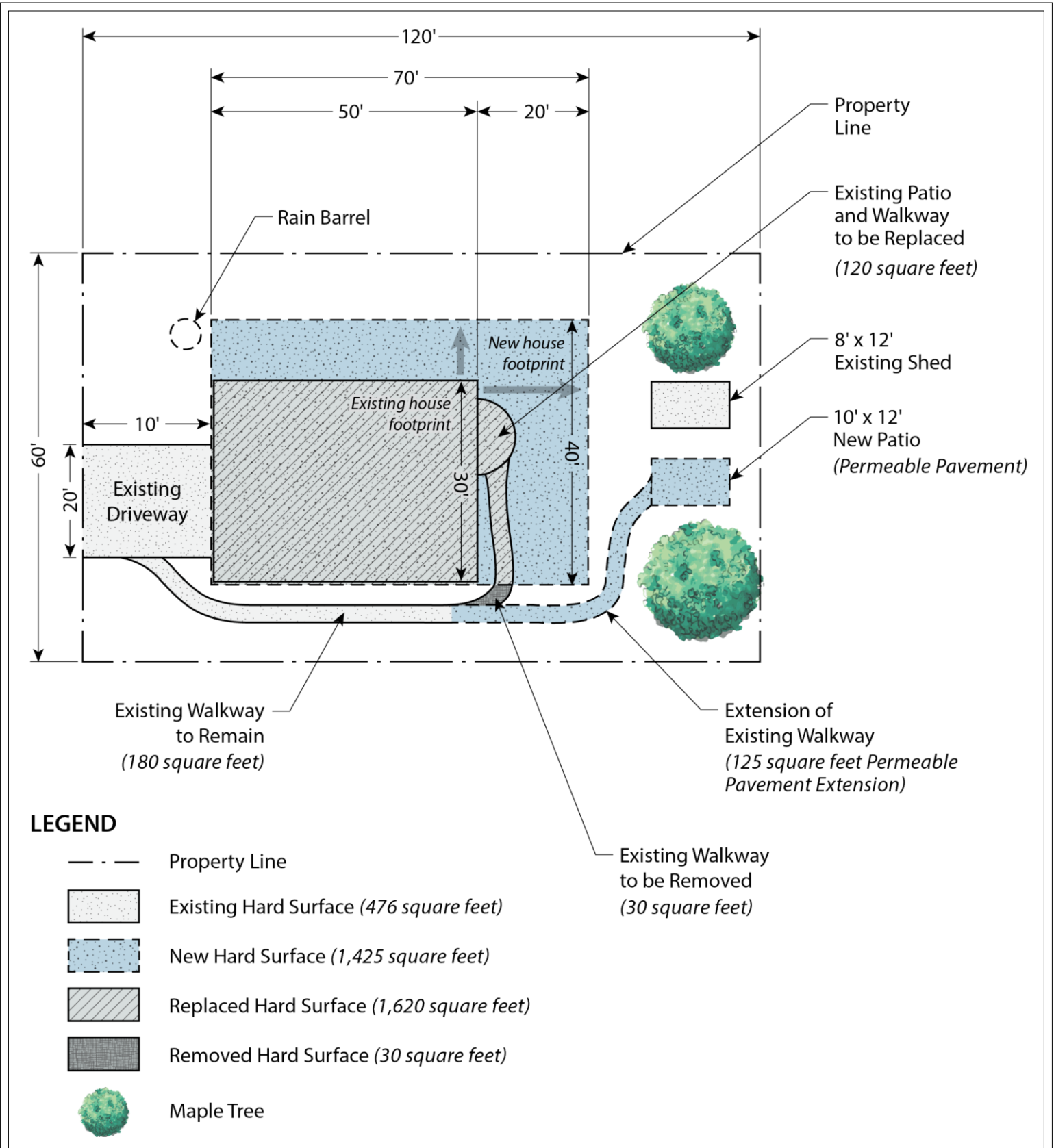
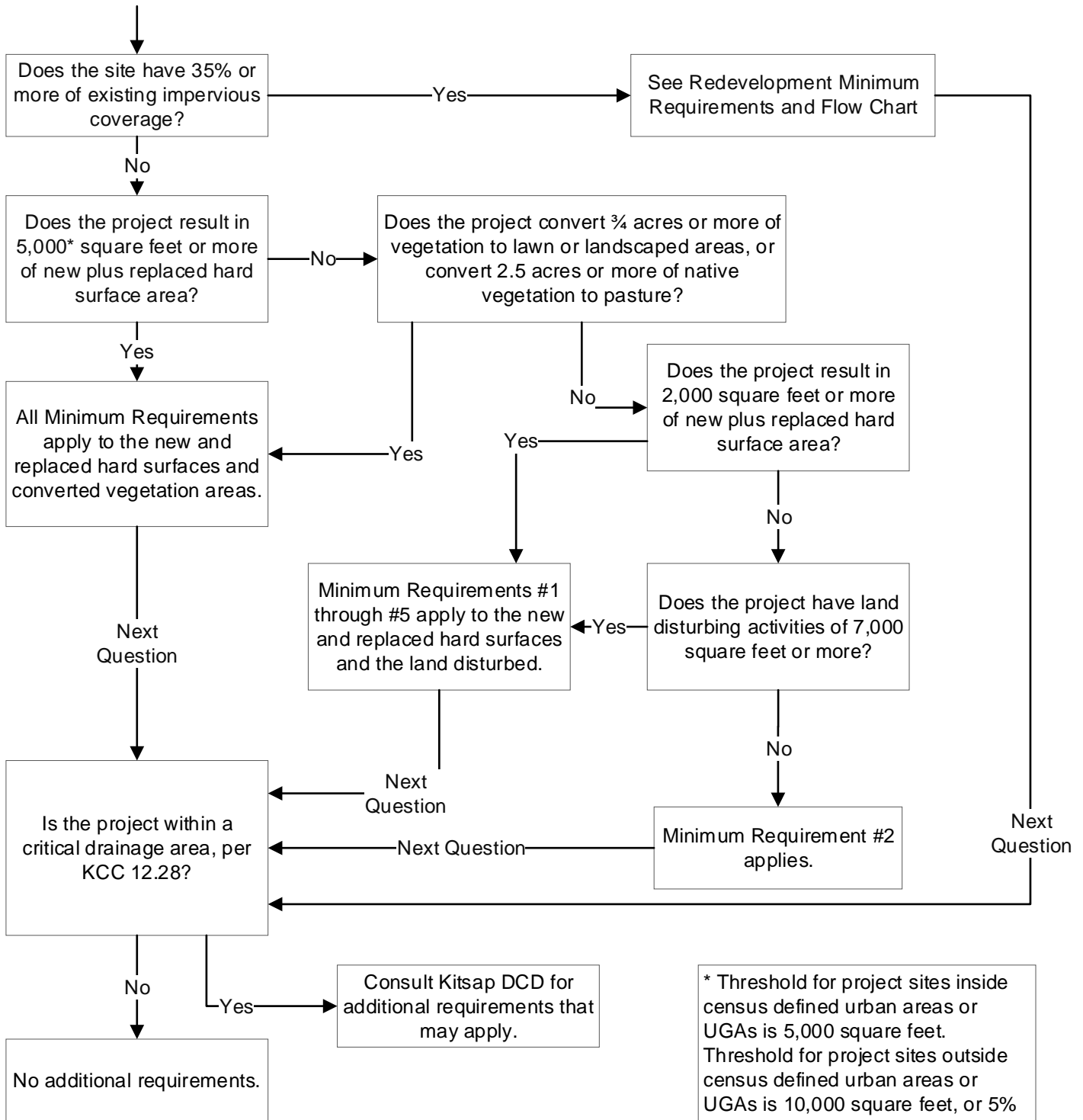


Figure 3.1
Example Determination of New
and Replaced Hard Surfaces

Start Here



* Threshold for project sites inside census defined urban areas or UGAs is 5,000 square feet. Threshold for project sites outside census defined urban areas or UGAs is 10,000 square feet, or 5% of the lot area (whichever is greater).



Figure 4.1
Flow Chart for Determining Minimum Requirements for New Development Projects

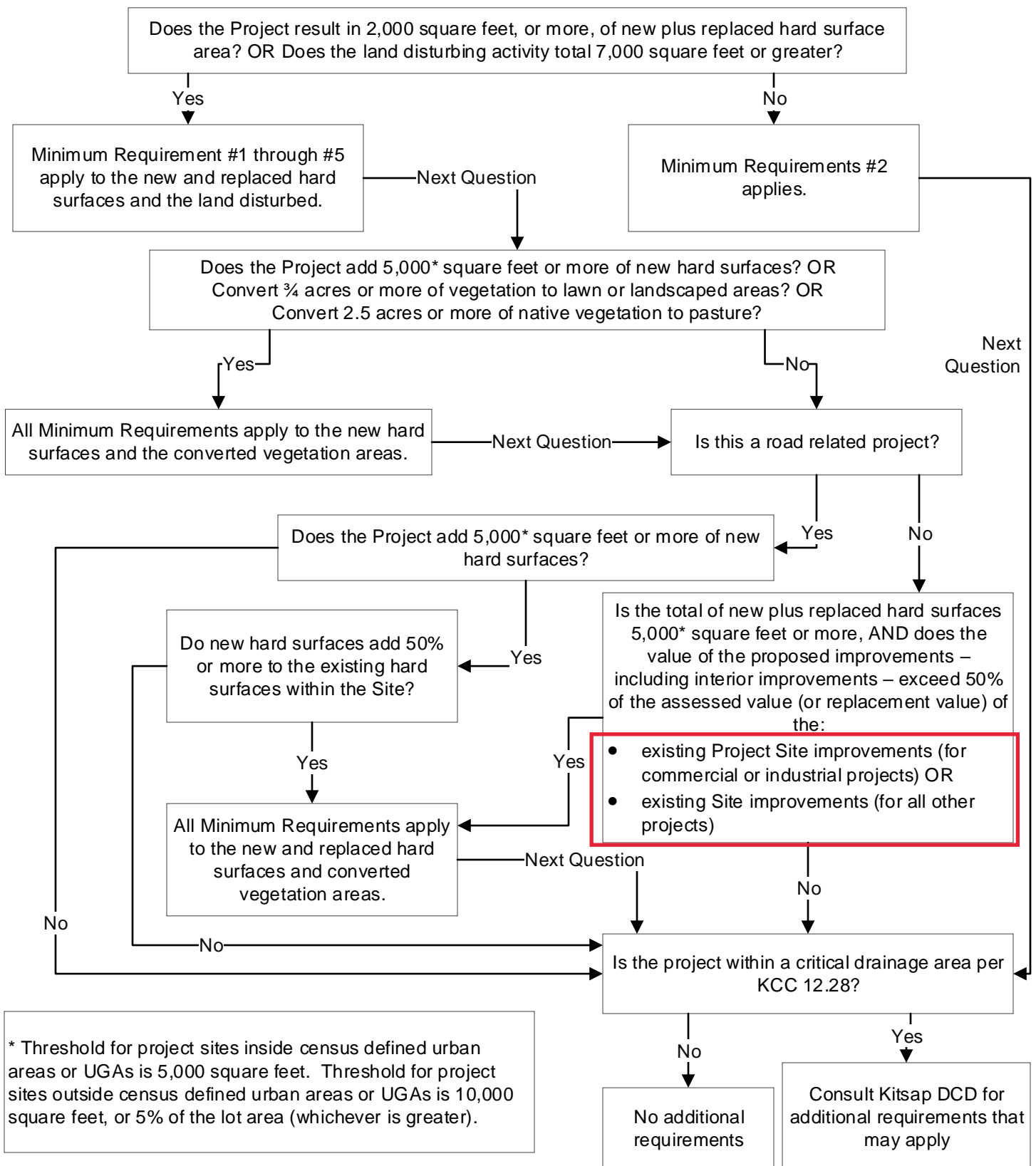


Figure 4.2
Flow Chart for Determining
Minimum Requirements for
Redevelopment Projects

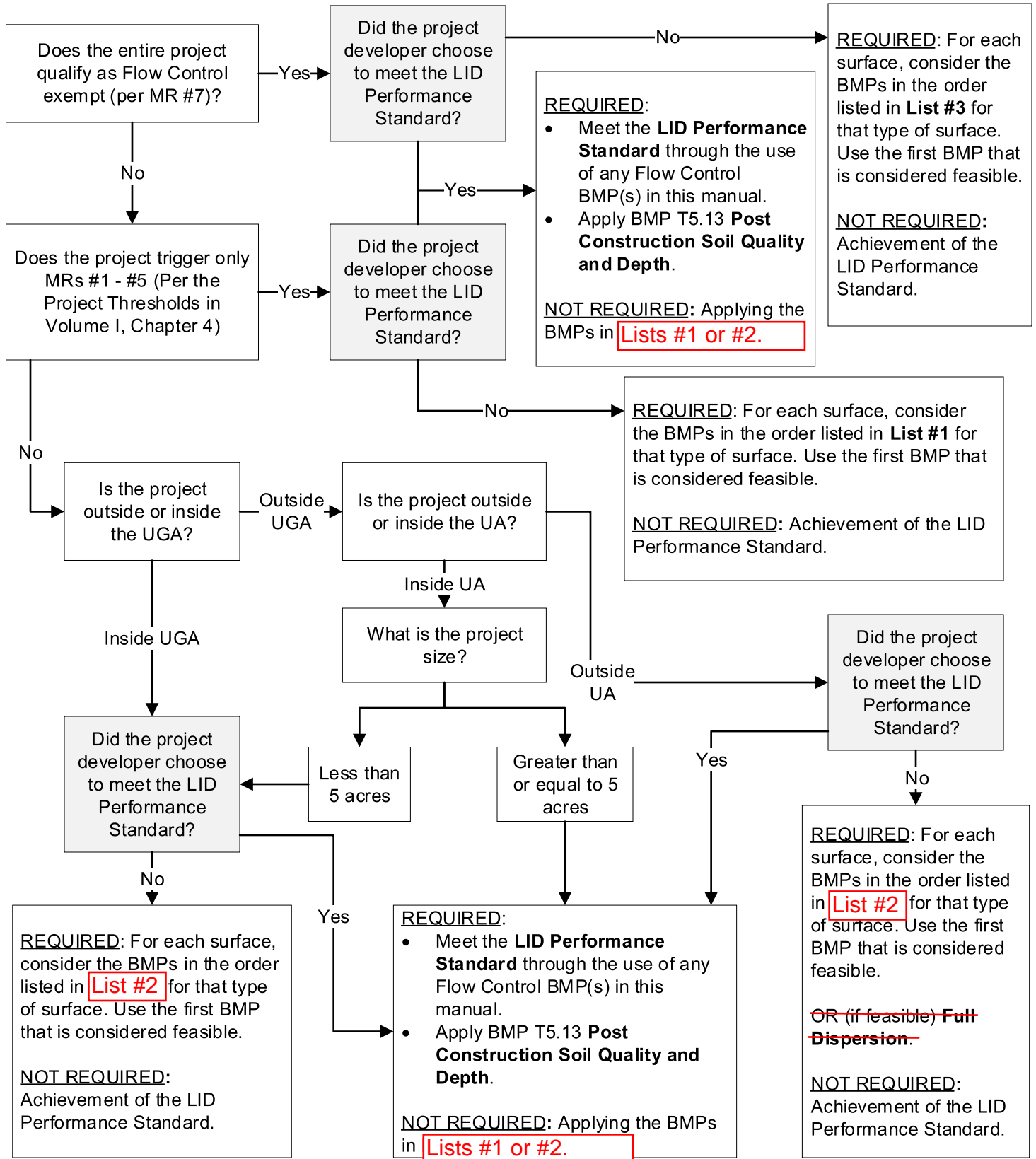


Figure 4.3
Flow Chart for Determining MR #5 Requirements

Volume I Photos

Volume I, Section 2.3 Photo



Bioretention BMP in a cul-de-sac of a LID residential neighborhood in construction in western WA. The bioretention manages stormwater runoff from the roadway and contributing roof and driveway areas. Numerous large existing trees were retained, adding valuable stormwater and community benefits.

Volume I, Section 4.2.2, Element 6 Photo



Example of shallow gradient slope with berm installed at downgradient edge to minimize silt-laden runoff onto the sidewalk.

Volume I, Section 4.2.2, Element 9 Photo



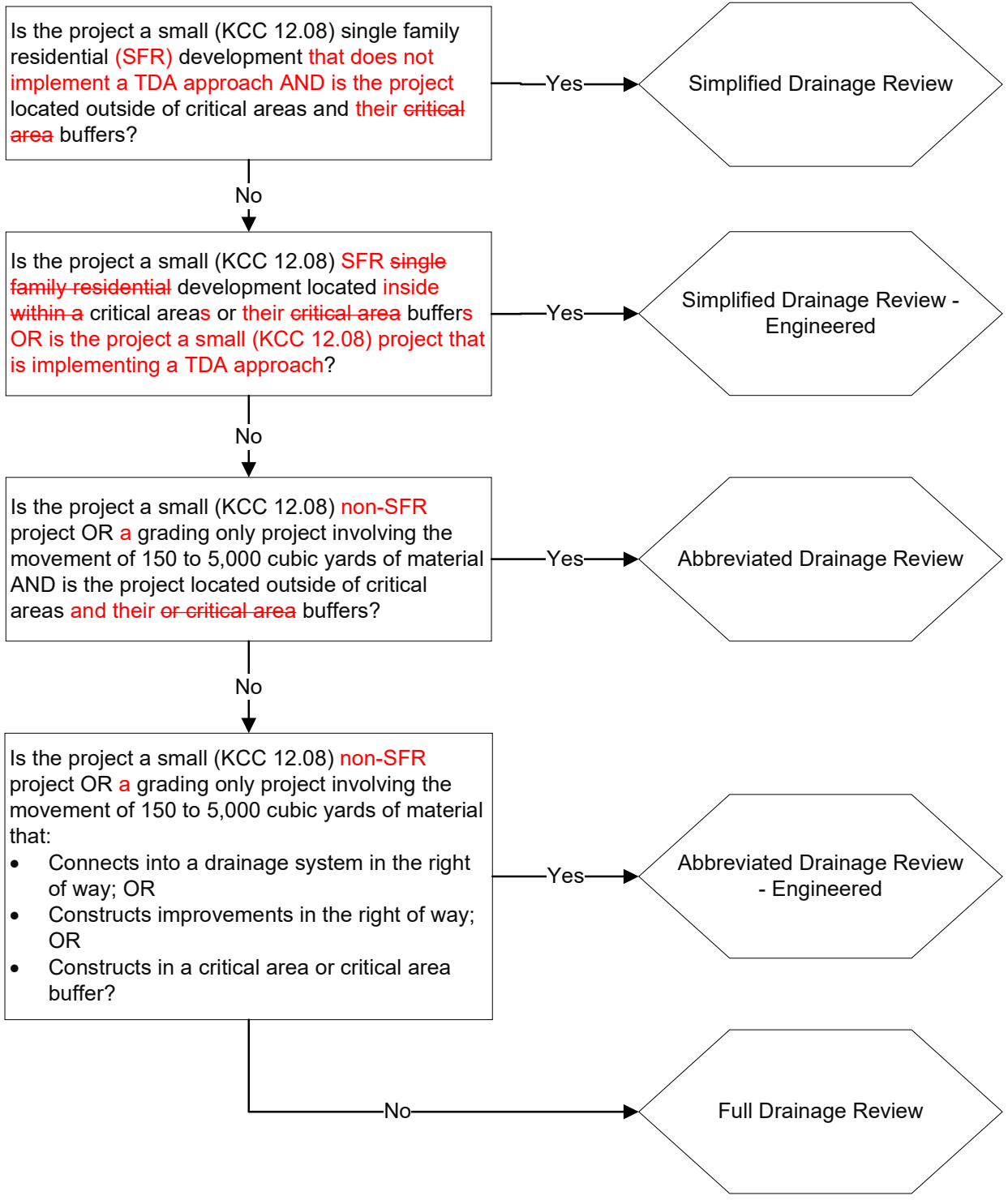
Temporary sand bags divert construction site stormwater runoff to inlet protected with a catch basin filter sock.

Volume I, Section 4.2.2, Element 13 Photo



Sand bags prevent silt-laden flow from entering the bioretention BMP. Green construction fencing prevents compaction due to foot traffic.

Volume II Figures



Flow Chart for Determining Type of Drainage Review

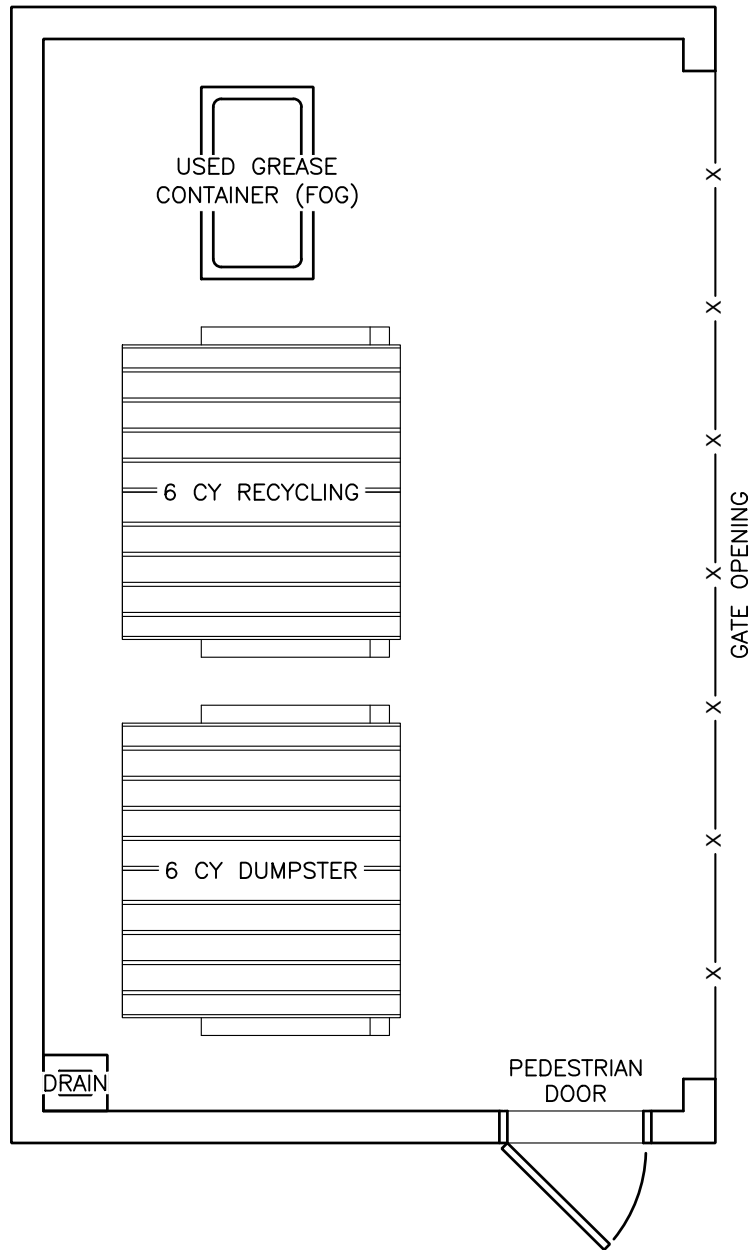


Figure 3.1
 Example of a covered, bermed
 and plumbed area - plan view

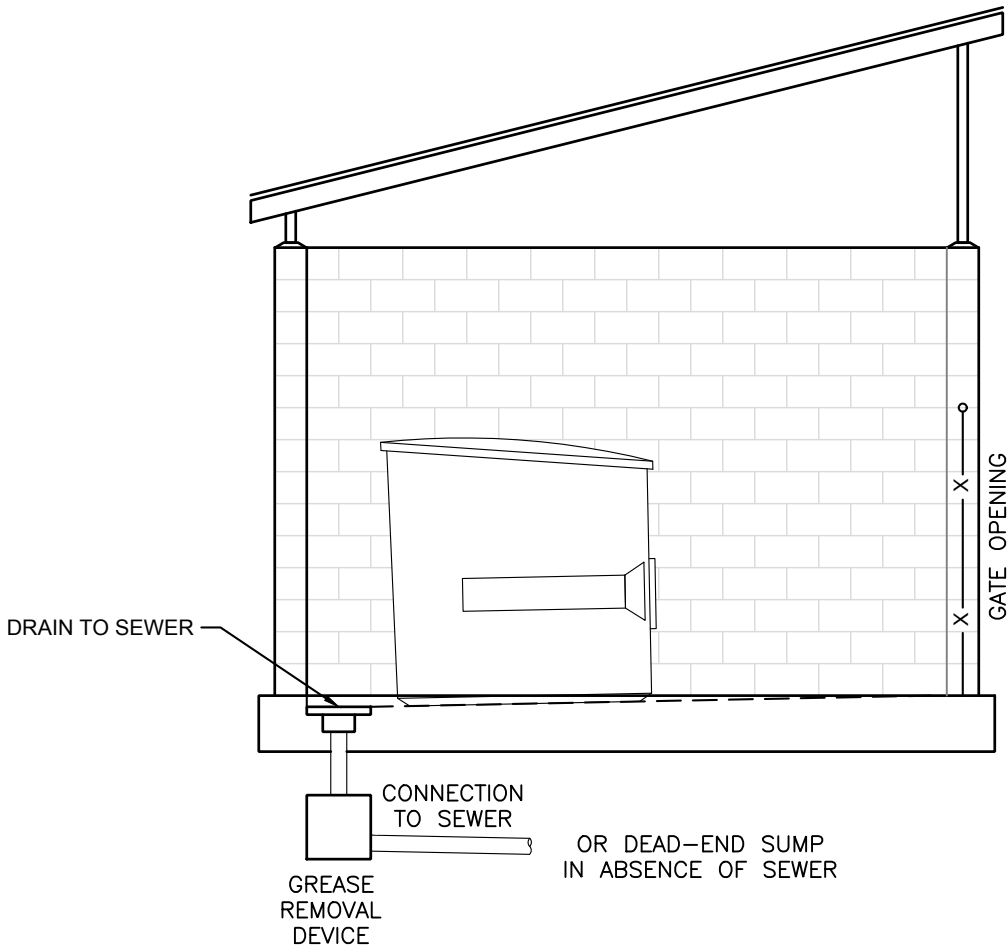
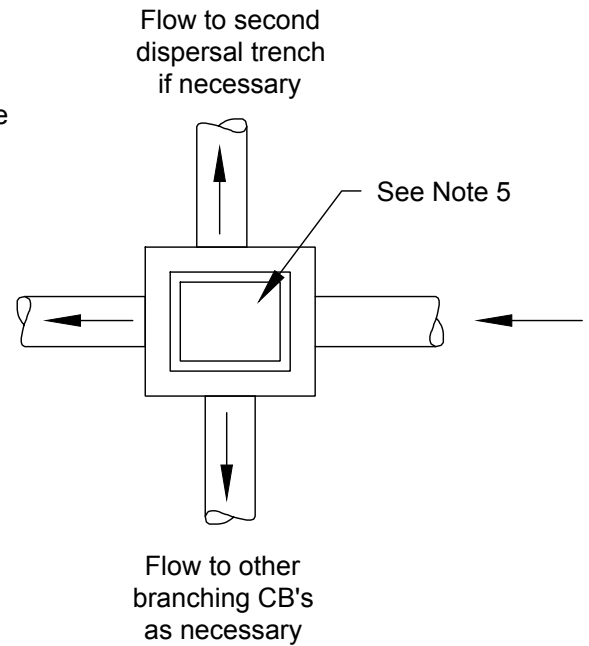
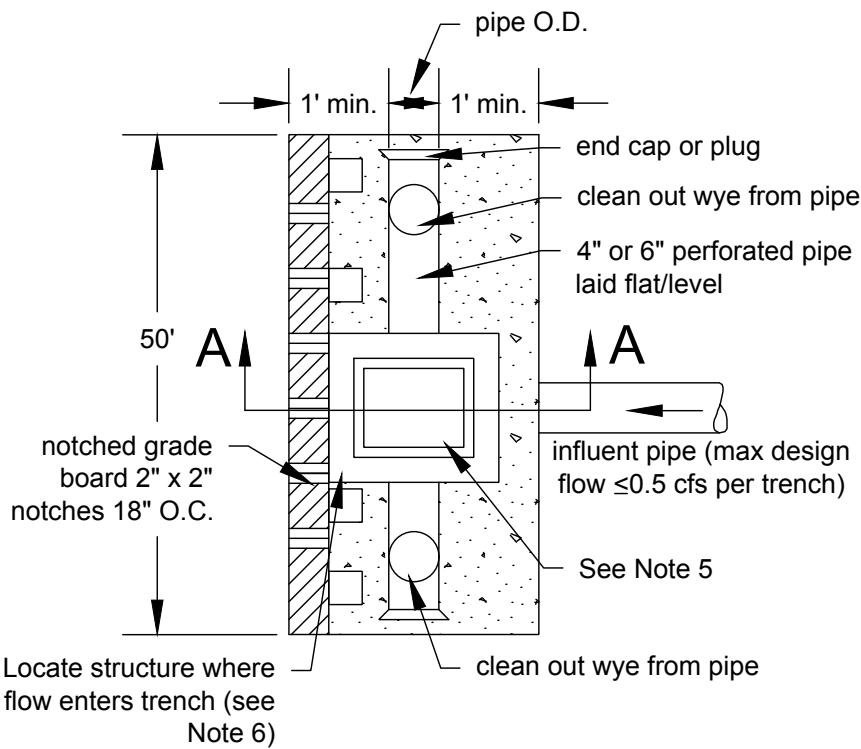
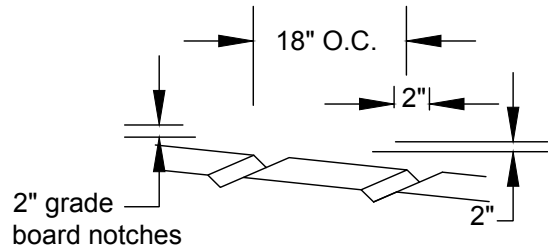
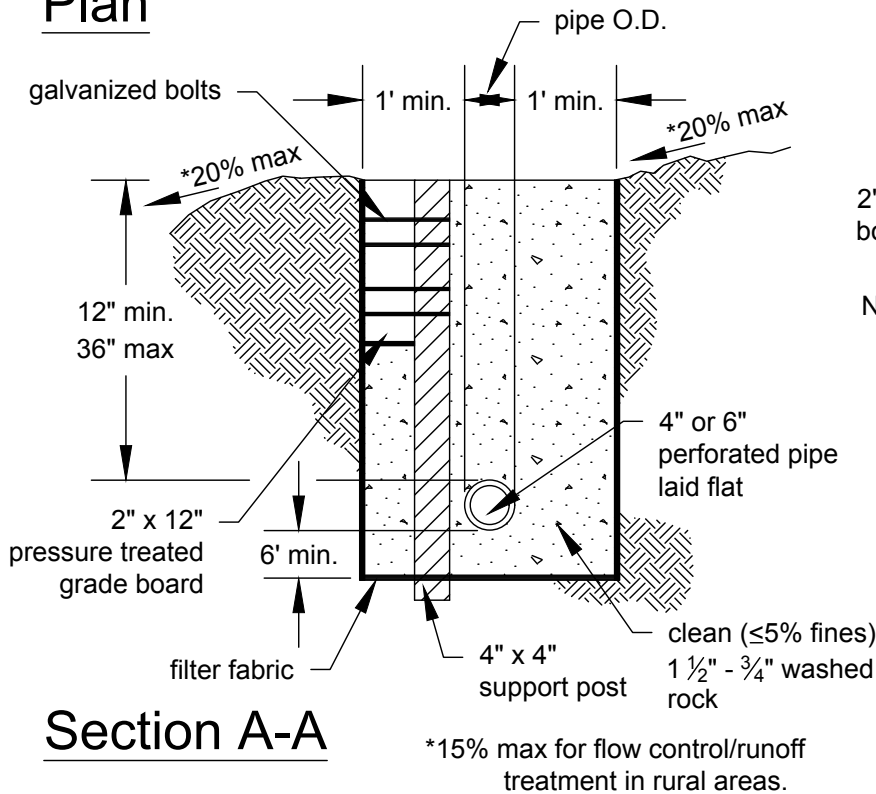


Figure 3.2
 Example of a covered, bermed
 and plumbed area - side view

\\herra\ra-local\herra\seattle\proj\12019\19-07028-000\CAD\DWG\FIG 3.dwg



Plan

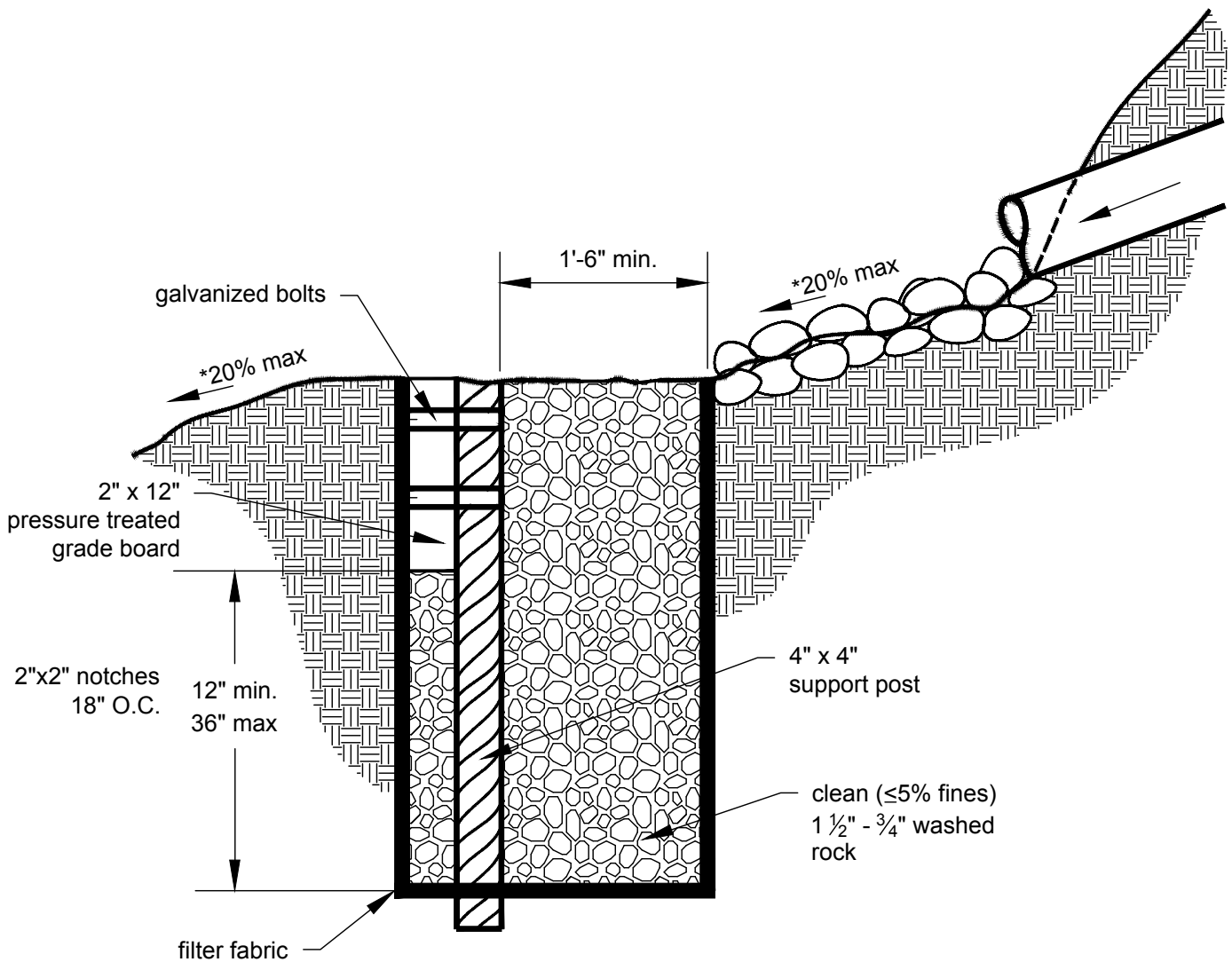


Notes:

1. This trench shall be constructed so as to prevent point discharge and/or erosion.
 2. Trenches may be placed no closer than 50 feet to one another. (100 feet along flowline)
 3. Trench and grade board must be level. Align to follow contours of site.
 4. Support post spacing as required by soil conditions to ensure grade board remains level.
 5. For roof area less than or equal to 700 square feet, structure shall be a small catch basin, yard drain, or Type 1 CB with with solid cover or equivalent as approved by the County.
 6. Structure shall be set back a minimum of 5 feet from building foundation.
- NOT TO SCALE



Figure 4.1
Flow Dispersion Trench



*15% max for flow control/runoff treatment in rural areas.

Section A-A

Notes:

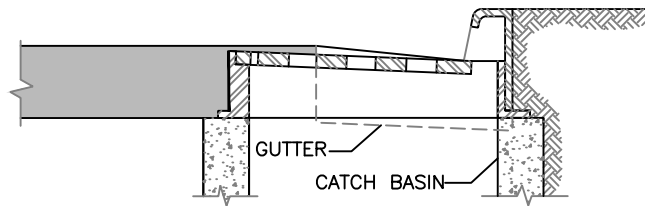
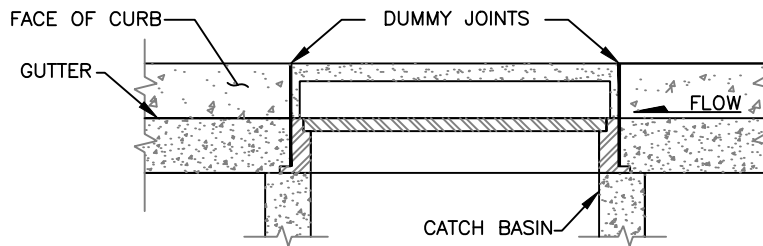
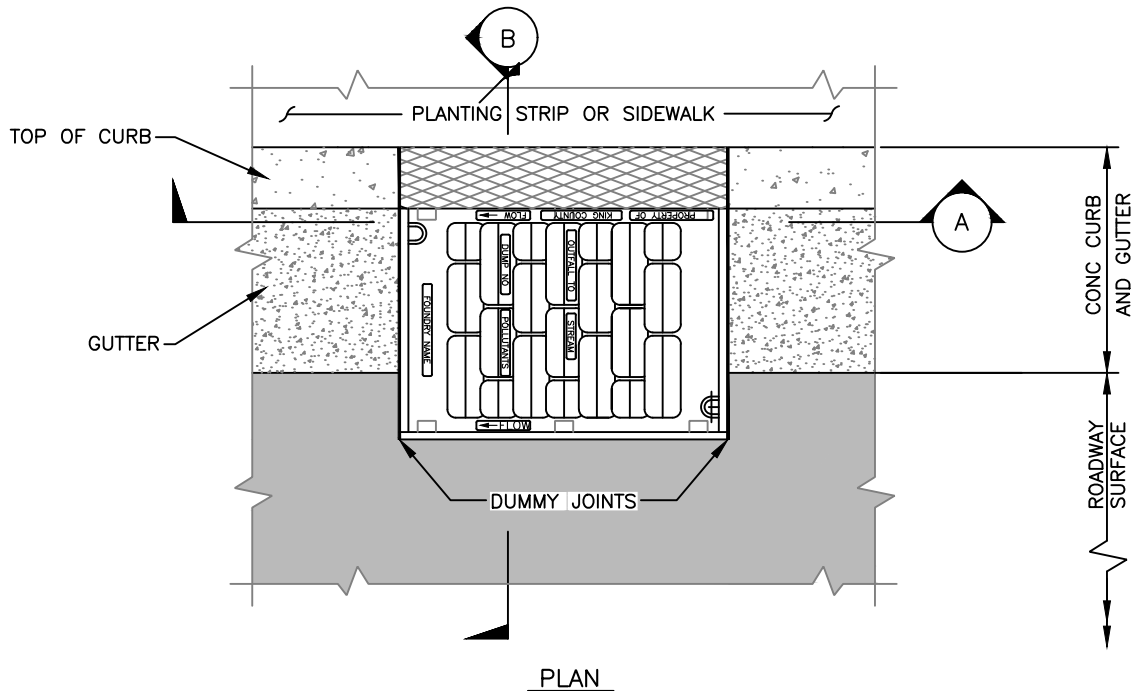
1. This trench shall be constructed so as to prevent point discharge and/or erosion.
2. Trenches may be placed no closer than 50 feet to one another. (100 feet along flowline)
3. Trench and grade board must be level. Align to follow contours of site.
4. Support post spacing as required by soil conditions to ensure grade board remains level.

NOT TO SCALE



Figure 4.2
Alternative Flow Dispersion Trench

\\herra-local\herra\cnet\seattle\proj\2019\19-07028-000\CAD\DWG\Final\CAD_files\Fig4_2AltFlowDispersionTrench.dwg

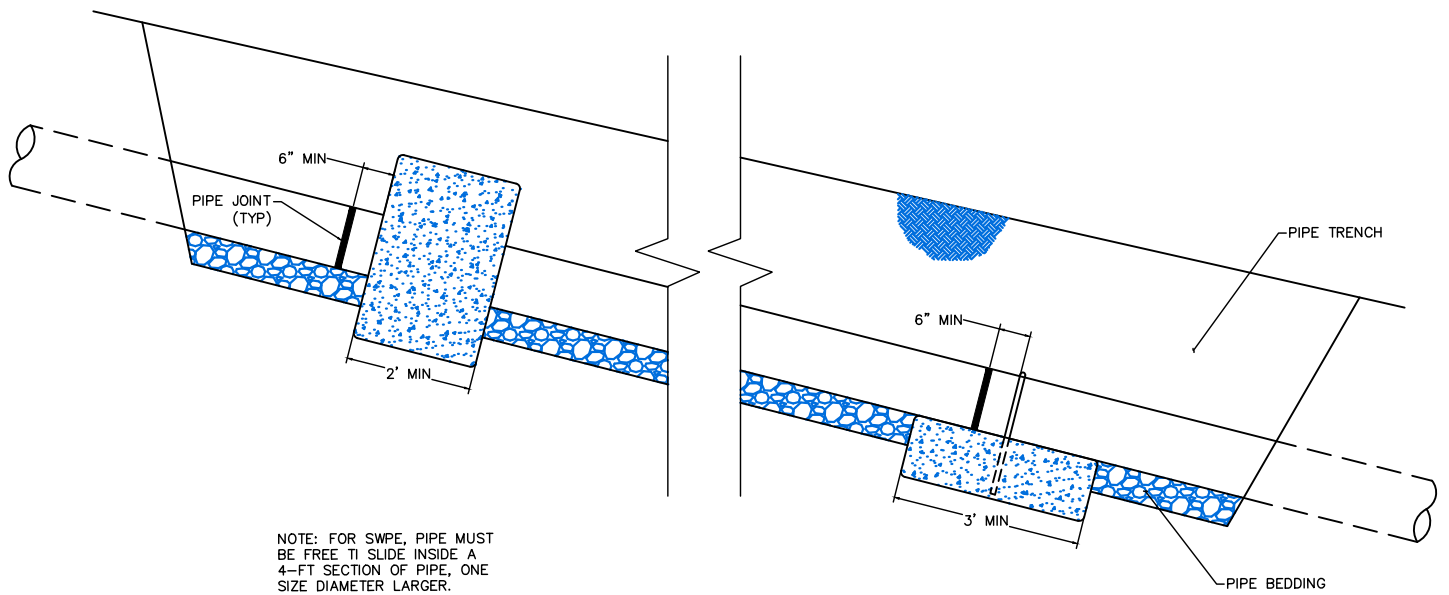


NOTES:

1. SET TO GRADE AND CONSTRUCT ROAD AND GUTTER TO BE FLUSH WITH FRAME.
2. SEE SEC. 3.04 FOR JOINT REQUIREMENTS.
3. SEE WSDOT/APWA STANDARD SPECIFICATIONS SECTION 9-05.15 FOR METAL GRATINGS REQUIREMENTS.

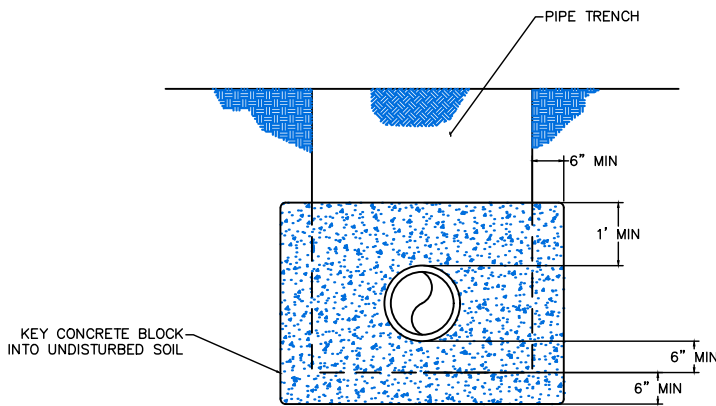


Figure 4.3
Through-Curb Inlet

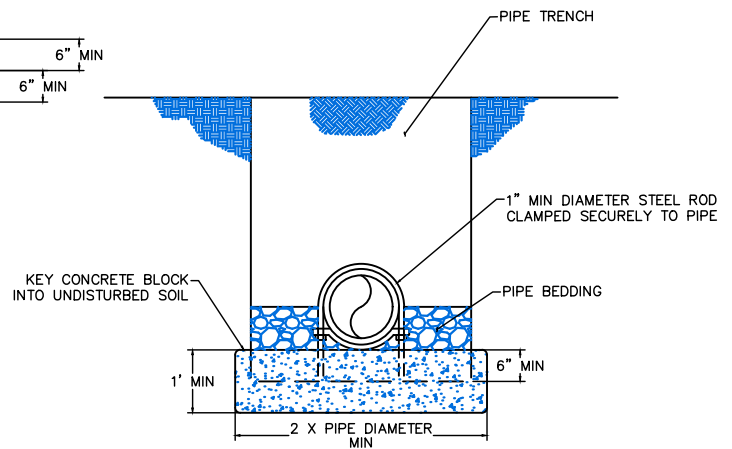


NOTE: FOR SWPE, PIPE MUST BE FREE TO SLIDE INSIDE A 4-FT SECTION OF PIPE, ONE SIZE DIAMETER LARGER.

SWPE PIPE ANCHOR DETAIL
NTS



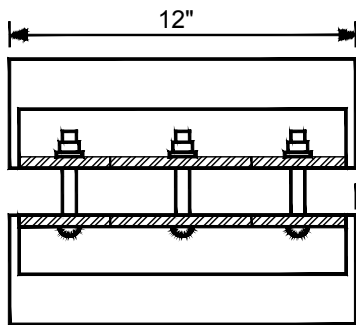
SECTION A-A
NTS



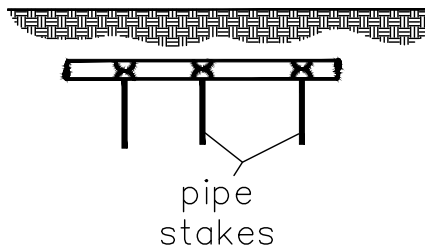
SECTION B-B
NTS



Figure 4.4
Pipe Anchor Detail



Smooth Coupling Band
for Smooth Pipe



pipe
stakes

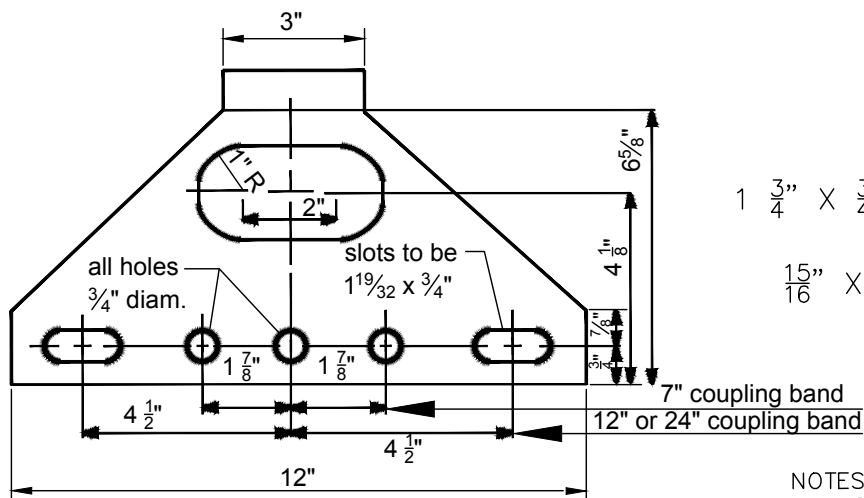
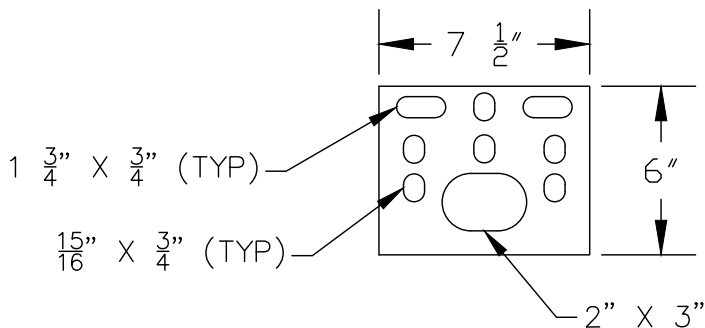
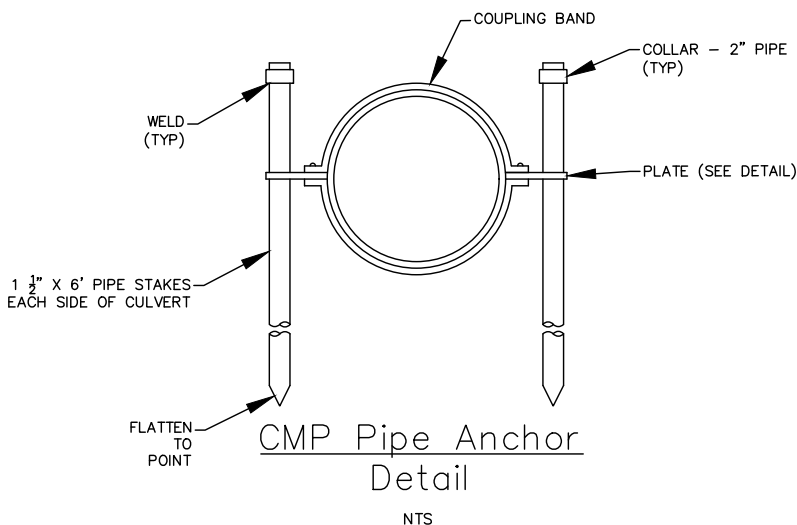


Plate Detail



NOTES:

1. STAKES AND PLATES SHALL BE GALVANIZED PER ASTM A 36 AND A 153.
2. THE SMOOTH COUPLING BAND SHALL BE PER WSDOT STD PLANS B-60.20-01 AND B-60.20-01 AND USED IN COMBINATION WITH CONCRETE PIPE.
3. CONCRETE PIPE WITHOUT A BELL AND SPIGOT CONNECTION SHALL NOT BE INSTALLED ON GRADES IN EXCESS OF 20%.
4. THE FIRST ANCHOR SHALL BE INSTALLED ON THE FIRST SECTION OF THE LOWER END OF THE PIPE; THE REMAINING ANCHORS SHALL BE EVENLY SPACED THROUGHOUT THE INSTALLATION.
5. IF THE PIPE BEING INSTALLED HAS A MANHOLE OR CATCH BASIN ON THE LOWER END OF THE PIPE, THE FIRST PIPE ANCHOR MAY BE ELIMINATED.
6. WHEN CMP IS USED, THE ANCHORS MAY BE ATTACHED TO THE COUPLING BANDS USED TO JOIN THE PIPE AS LONG AS THE SPECIFIED SPACING IS NOT EXCEEDED.
7. ALL PIPE ANCHORS SHALL BE SECURELY INSTALLED BEFORE BACKFILLING AROUND THE PIPE.

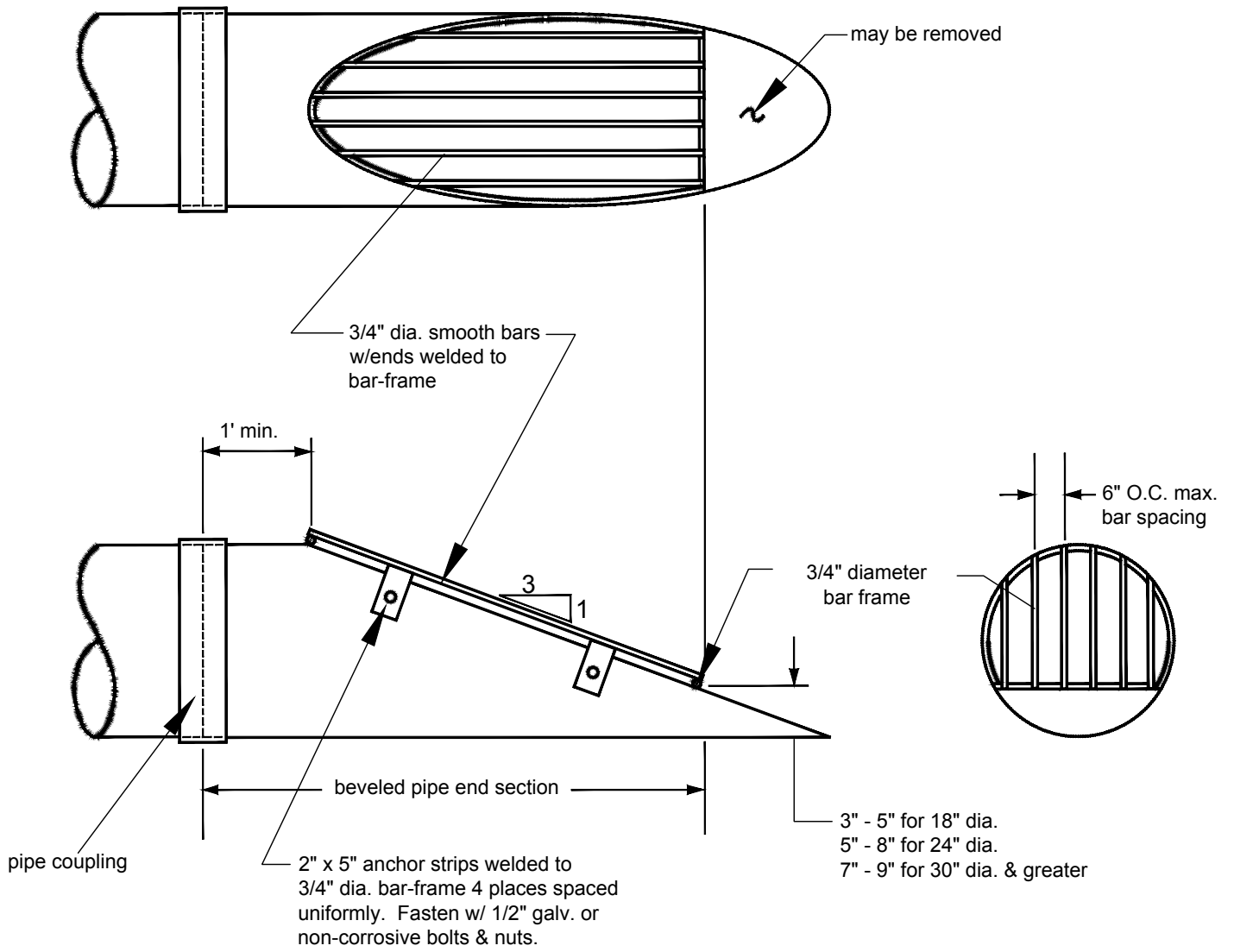


CMP Pipe Anchor
Detail

NTS



Figure 4.5
Corrugated Metal Pipe Coupling Anchor Assembly



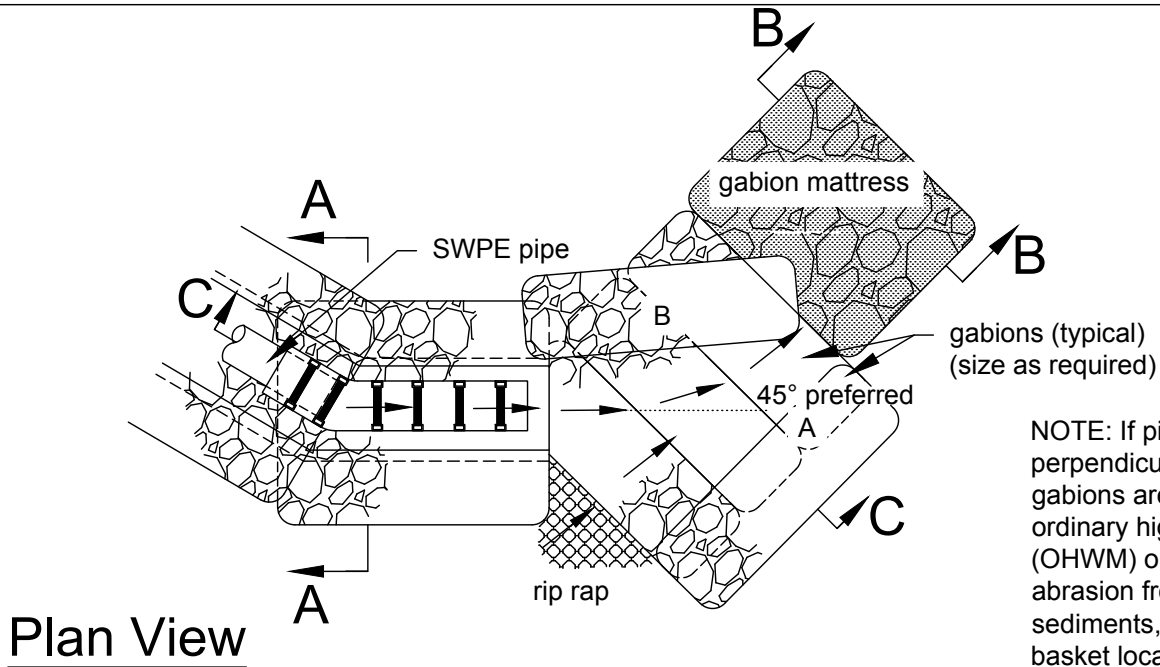
NOTES:

1. CMP or LCPE pipe end-section shown; for concrete pipe beveled end section, see KCRS drawing No. 2-001.
2. All steel parts must be galvanized and asphalt coated (treatment 1 or better).

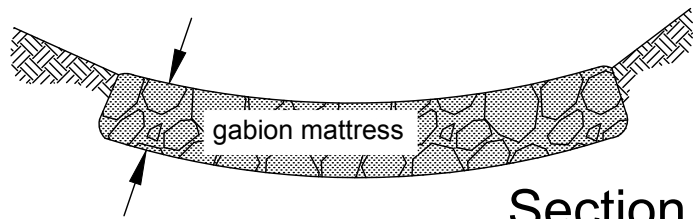
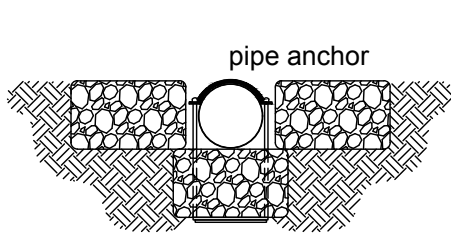


Figure 4.6
Debris Barrier (In Road Right-of-Way)

\\herra\local\hcnell\seattle\proj\1\2019\19-07028-000\CAD\Source\102419_Kitsap\Drawings Files\Files_from_KingCo\New with template\Fig4.6DebrisBarrierInROW.dwg

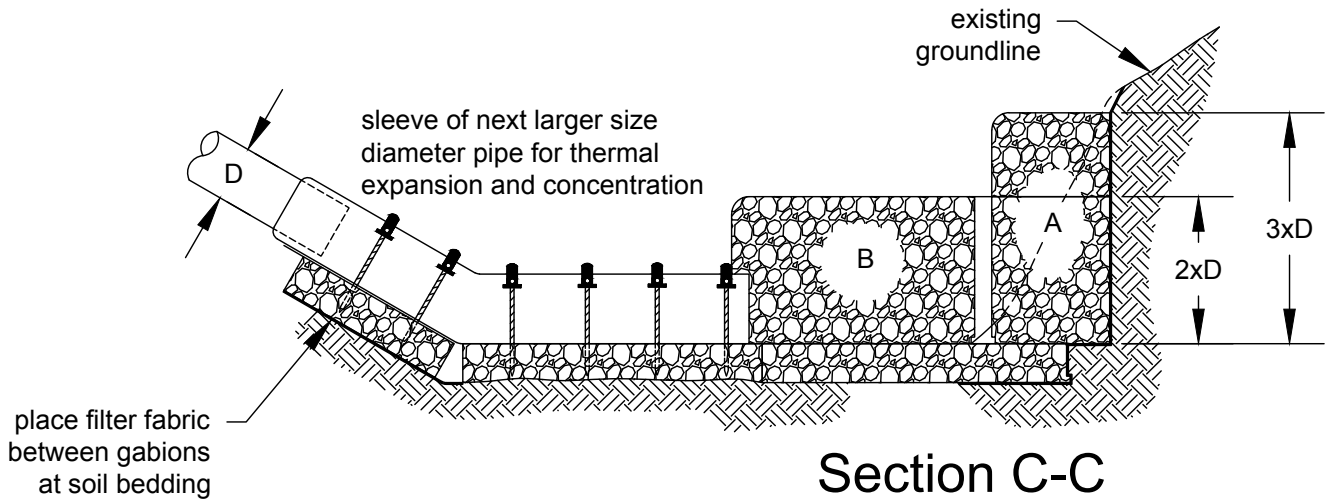


NOTE: If pipe discharges perpendicular to stream, or gabions are located within the ordinary high water mark (OHWM) or will be subject to abrasion from upstream sediments, a four-sided gabion basket located outside the OHWM should be considered.



Section A-A

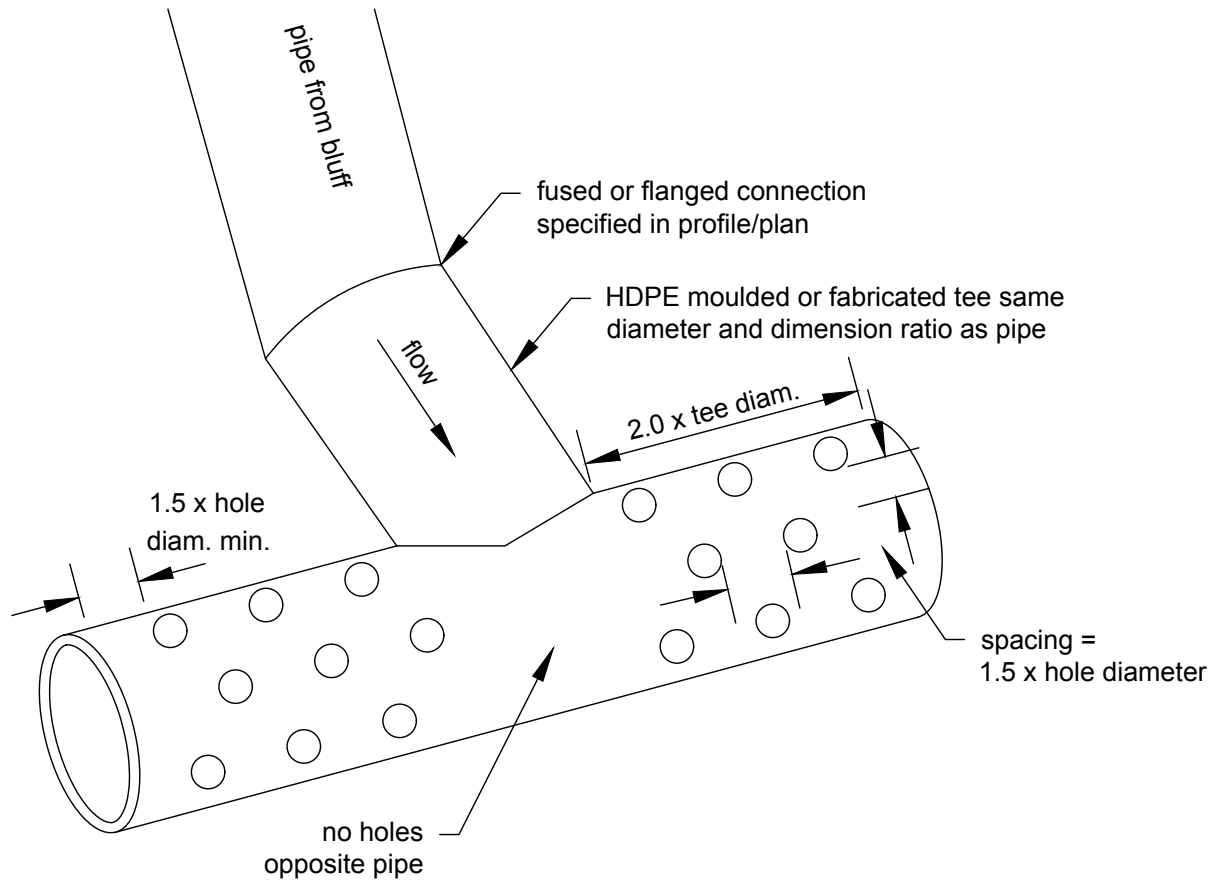
Section B-B



NOT TO SCALE



Figure 4.7
Gabion Outfall Detail

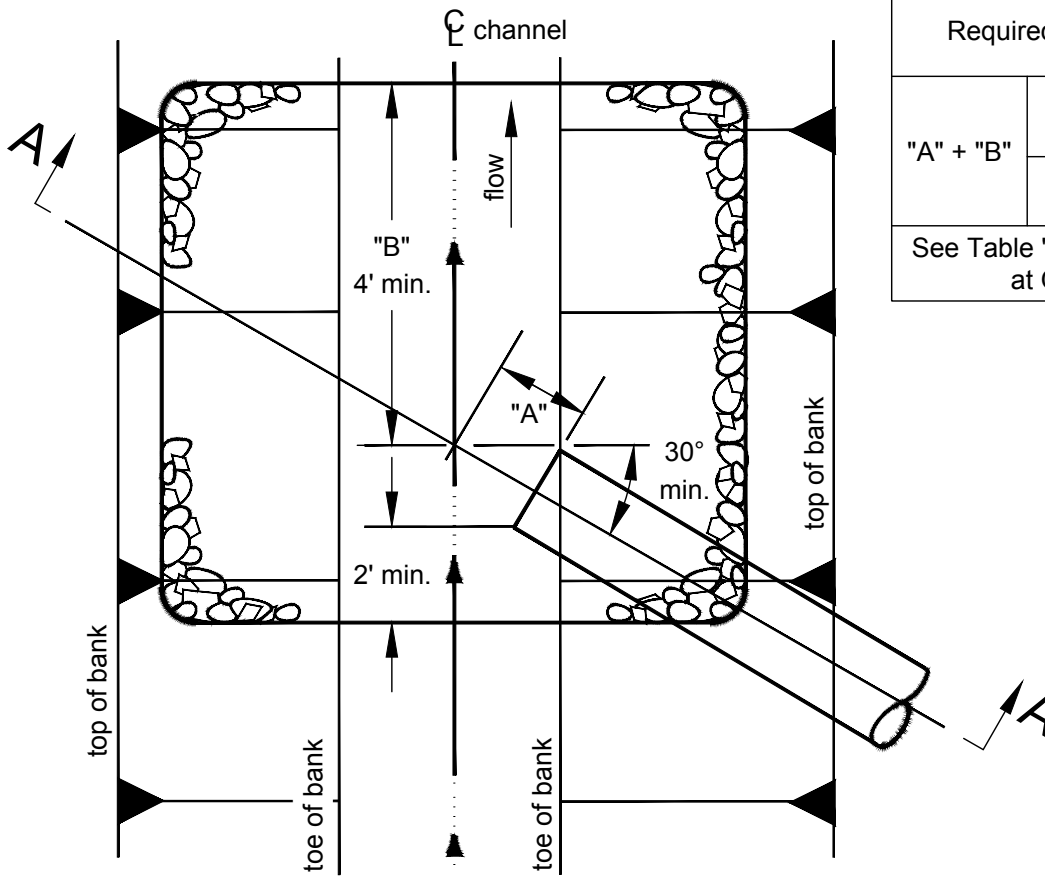


Drill holes in front half of tee only.
 Hole diameter (inches) = tee diameter (inches) divided by 6
 (ex. 6 inch tee = 1 inch holes
 18 inch tee = 3 inch holes)

NOT TO SCALE

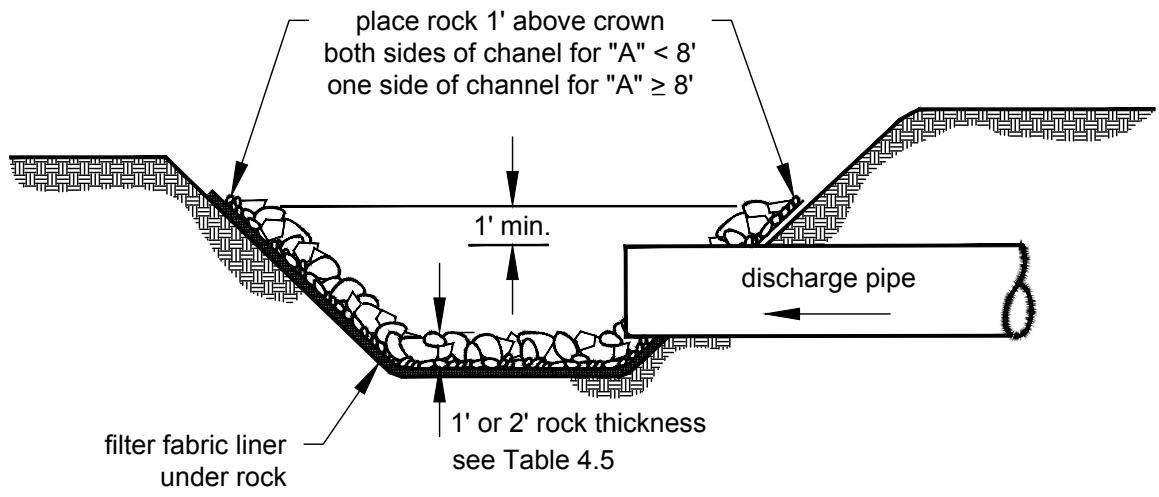
Figure 4.8
Diffuser TEE
 (an example of energy dissipating end feature)





Required Dimensions	
"A" + "B"	8' for rock lining
	12' for rip rap
See Table "Rock Protection at Outfalls"	

Plan



Section A-A

NOT TO SCALE



Figure 4.9
Pipe/Culvert Outfall Discharge Protection

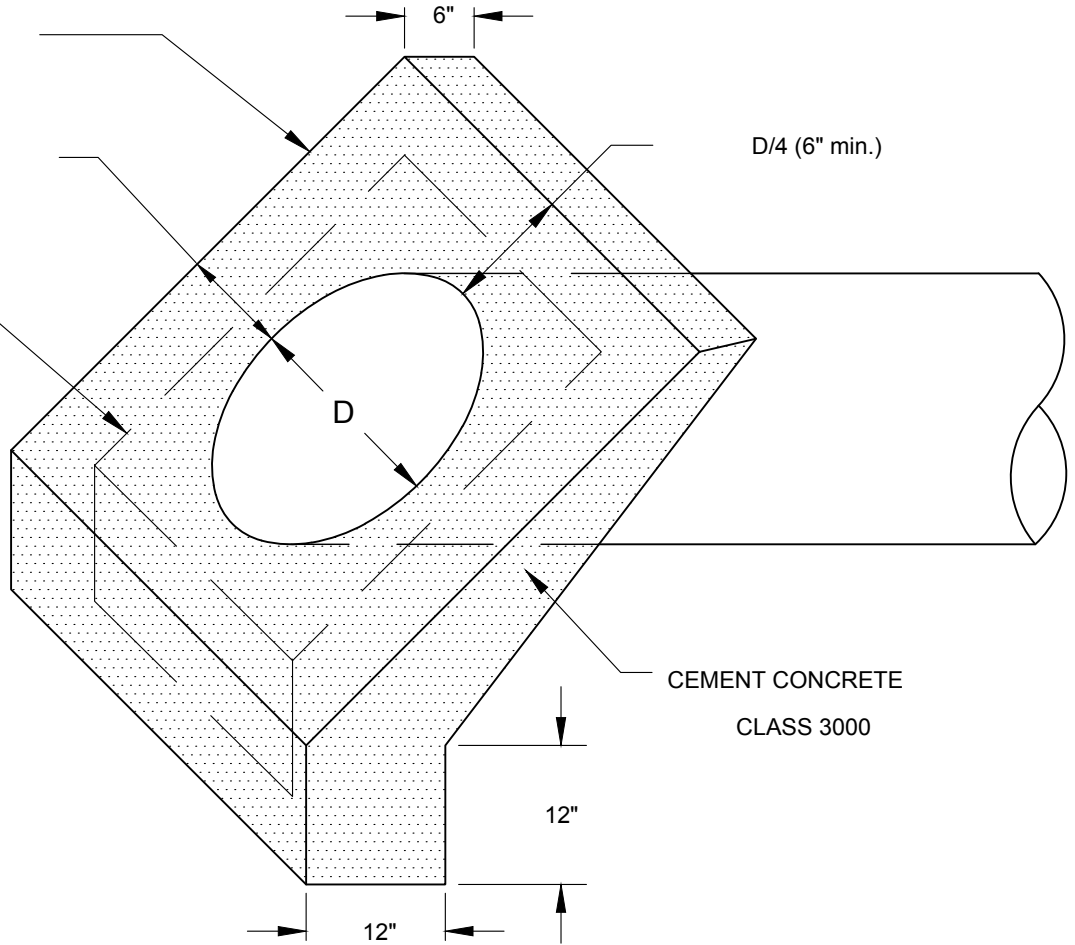
\\harrera.local\hce\enat\seattle\proj\2019\19-07028-000\CADD\Source\102419_Kitsap\Drawings\Files\New with template\Fig4_9PipeCulvertDischargeProtection.dwg

\\harrara.local\hccnet\seattle\proj\2019\19-07028-000\CAD\Source\102419_Kitsap\Drawings\Files\102419_Kitsap\New with template\Fig4.10ConcreteEndProtection.dwg

SLOPE FRONT FACE TO
COINCIDE WITH EMBANKMENT
OR DITCH SLOPE

D/4 (6" min.)

1 #4 BAR,
CONTINUOUS
(SPLICE OK)



CEMENT CONCRETE
CLASS 3000

NOTE:

REINFORCING STEEL SHALL HAVE 1 1/2 INCH CLEAR
COVER TO ALL CONCRETE SURFACES AND SHALL BE
GRADE 40 OR GRADE 60.



Figure 4.10
Concrete End Protection

NO.	DIMENSIONS				HYDRAULICS			
	Side Slopes	B	H	W	A	WP	R	$R^{(2/3)}$
D-1	--	--	6.5"	5'-0"	1.84	5.16	0.356	0.502
D-1C	--	--	6"	25'-0"	6.25	25.5	0.245	0.392
D-2A	1.5:1	2'-0"	1'-0"	5'-0"	3.5	5.61	0.624	0.731
B	2:01	2'-0"	1'-0"	6'-0"	4	6.47	0.618	0.726
C	3:01	2'-0"	1'-0"	8'-0"	5	8.32	0.601	0.712
D-3A	1.5:1	3'-0"	1'-6"	7'-6"	7.88	8.41	0.937	0.957
B	2:01	3'-0"	1'-6"	9'-0"	9	9.71	0.927	0.951
C	3:01	3'-0"	1'-6"	12'-0"	11.25	12.49	0.901	0.933
D-4A	1.5:1	3'-0"	2'-0"	9'-0"	12	10.21	1.175	1.114
B	2:01	3'-0"	2'-0"	11'-0"	14	11.94	1.172	1.112
C	3:01	3'-0"	2'-0"	15'-0"	18	15.65	1.15	1.098
D-5A	1.5:1	4'-0"	3'-0"	13'-0"	25.5	13.82	1.846	1.505
B	2:01	4'-0"	3'-0"	16'-0"	30	16.42	1.827	1.495
C	3:01	4'-0"	3'-0"	22'-0"	39	21.97	1.775	1.466
D-6A	2:01	--	1'-0"	4'-0"	2	4.47	0.447	0.585
B	3:01	--	1'-0"	6'-0"	3	6.32	0.474	0.608
D-7A	2:01	--	2'-0"	8'-0"	8	8.94	0.894	0.928
B	3:01	--	2'-0"	12'-0"	12	12.65	0.949	0.965
D-8A	2:01	--	3'-0"	12'-0"	18	13.42	1.342	1.216
B	3:01	--	3'-0"	18'-0"	27	18.97	1.423	1.265
D-9	7:01	--	1'-0"	14'-0"	7	14.14	0.495	0.626
D-10	7:01	--	2'-0"	28'-0"	28	28.28	0.99	0.993
D-11	7:01	--	3'-0"	42'-0"	63	42.43	1.485	1.302

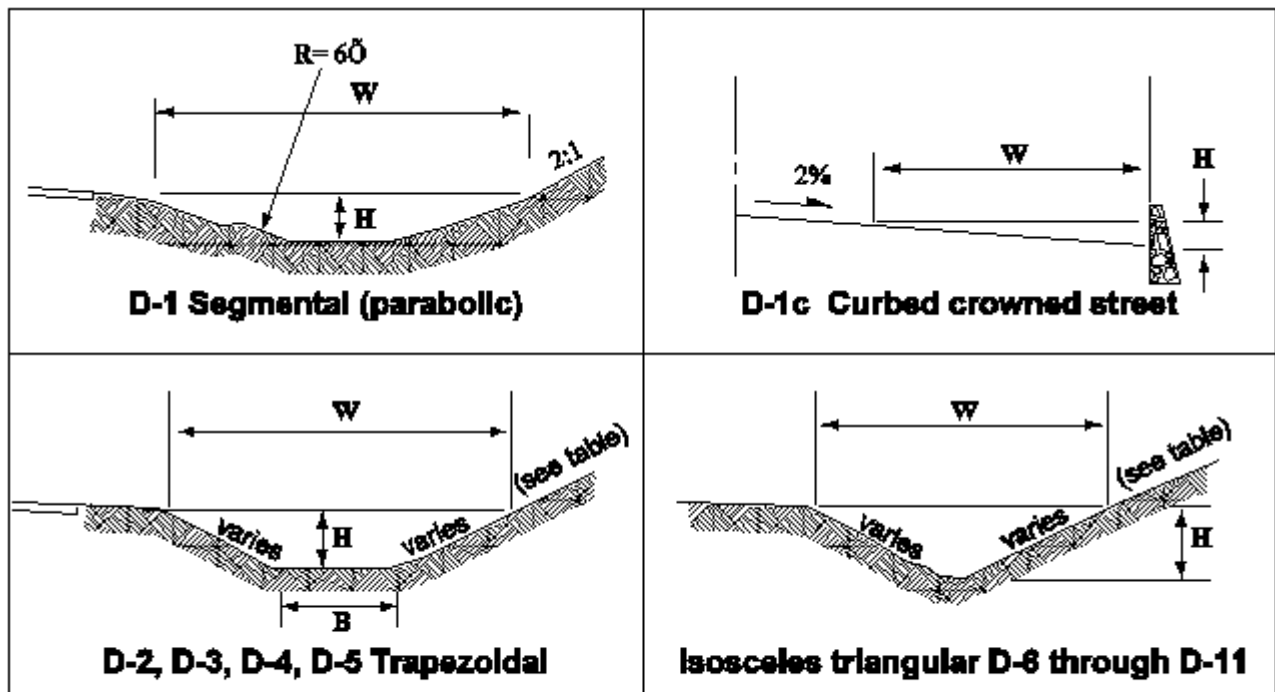


Figure 4.11
Ditches – Common Sections



NOTE: A) Chart based on Manning formula $Q=1.49n^2A^{2/3}S^{1/2}$ with $n=0.030$, except D-1C which is based on $n=0.015$. For other values of n , multiply discharge by $0.030/n$

B) 1 indicates a velocity of 1 ft. per sec.

Example: Given- Slope=3.3' per 1000', discharge=6.3 c.f.s., $n=0.025$.
 Required- Size of ditch and velocity. Solution- To use chart, multiply discharge, 6.3 by $(.03/.025) = 7.56$ c.f.s. Point satisfying given conditions lies between lines for D-2A and D-2B. Select larger of the two ditches, in this case D-2B. Velocity approx. 2.1 ft. per sec.

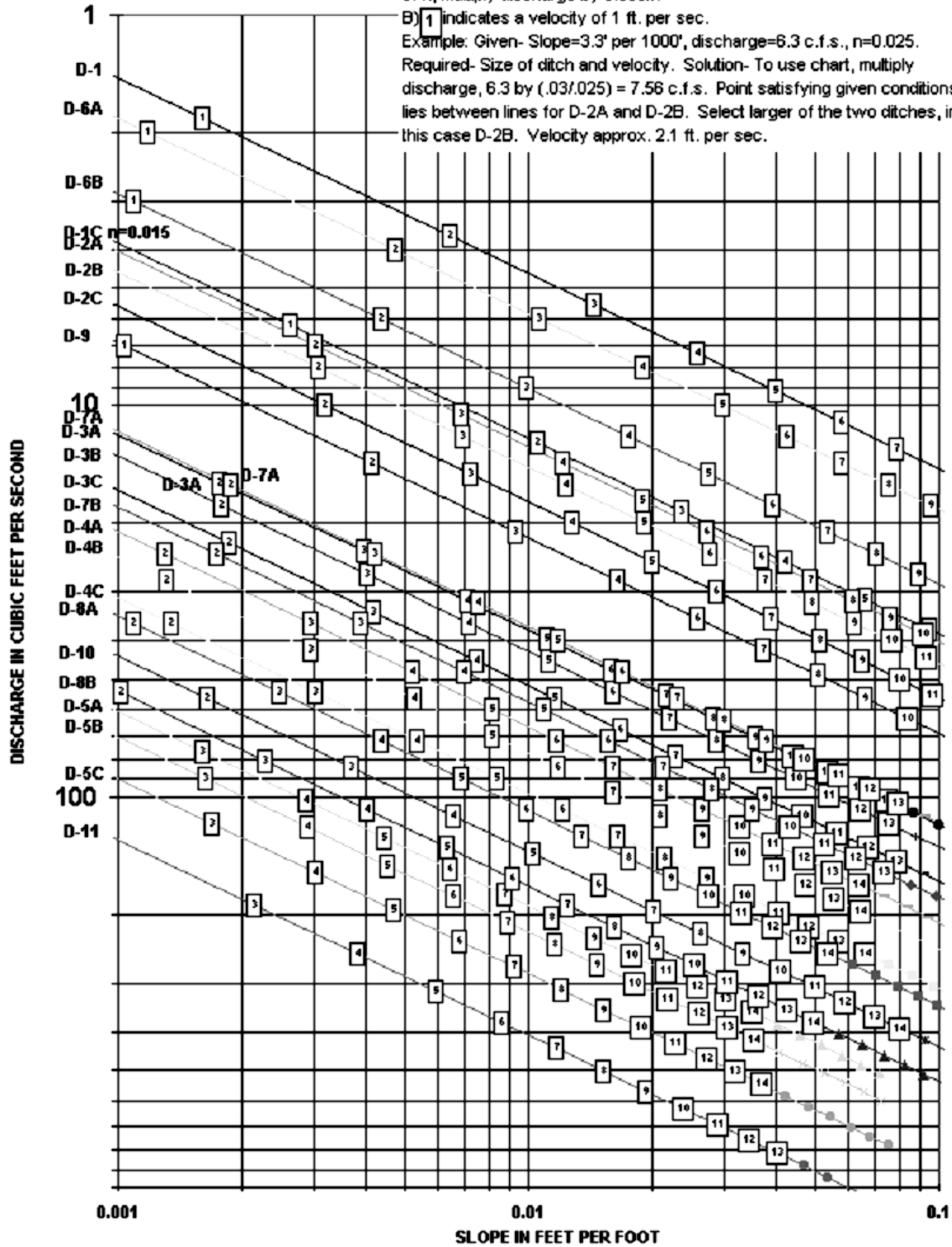


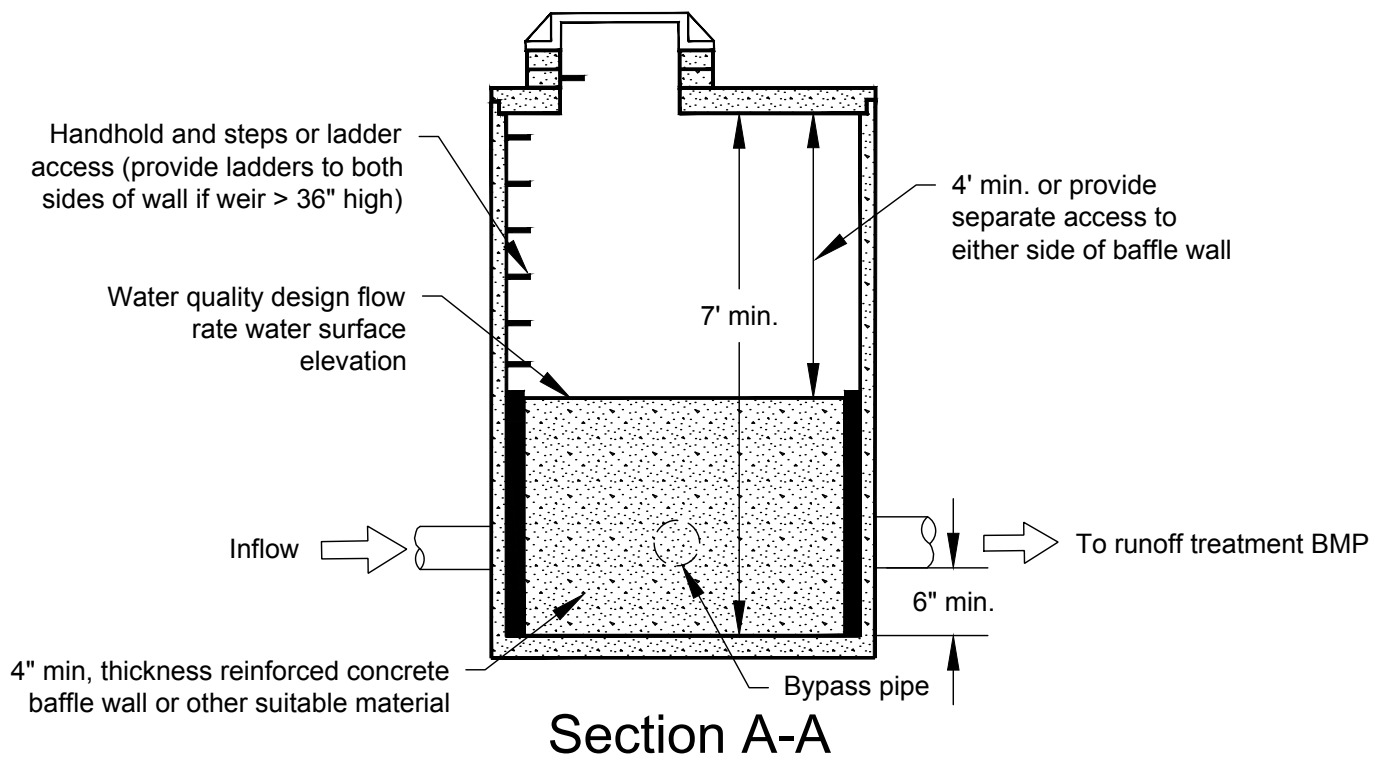
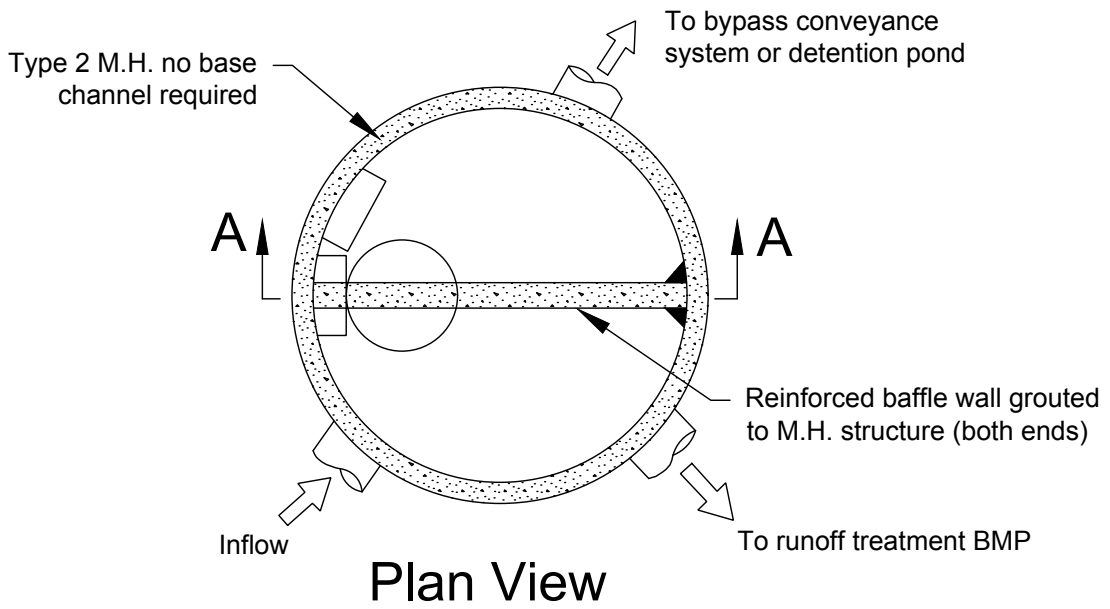
Figure 4.12
 Drainage Ditches –
 Common Sections



Section	Area A	Wetted perimeter P	Hydraulic radius R	Top width W	Hydraulic depth D	Section factor Z
 Rectangle	by	$b + 2y$	$\frac{by}{b + 2y}$	b	y	$by^{1.5}$
 Trapezoid	$(b + xy)y$	$b + 2y\sqrt{1 + x^2}$	$\frac{(b + xy)y}{b + 2y\sqrt{1 + x^2}}$	$b + 2xy$	$\frac{(b + xy)y}{b + 2xy}$	$\frac{[(b + xy)y]^{1.5}}{\sqrt{b + 2xy}}$
 Triangle	xy^2	$2y\sqrt{1 + x^2}$	$\frac{xy}{2\sqrt{1 + x^2}}$	$2xy$	$\frac{1}{3}y$	$\frac{\sqrt{2}}{2}xy^{1.5}$
 Orin	$\frac{1}{8}(D \sin \theta)^2 y^2$	$\frac{1}{2}\theta d$	$\frac{1}{4}(1D \sin^2 \theta) \frac{d^2}{\theta}$	$(\sin(\frac{1}{2}\theta)d) \frac{d}{2}$ or $2 \cdot y \cdot (\frac{d}{\theta} y)$	$\frac{1}{8} \left(\frac{\theta D \sin \theta}{\sin \frac{1}{2}\theta} \right) \frac{d^2}{\theta}$	$\frac{\sqrt{2} (\theta D \sin \theta)^{1.5}}{32 (\sin \frac{1}{2}\theta)^{0.5}} \frac{d^{2.5}}{\theta}$
 Parabola	$\frac{2}{3}Ty$	$T + \frac{8y^2}{3T}$	$\frac{2T^2 y}{3T^2 + 8y^2}$	$\frac{3A}{2y}$	$\frac{2}{3}y$	$\frac{2}{9}\sqrt{6Ty^{1.5}}$
 Round-bottomed Rectangle (R ²)	$(\frac{D}{2} D/2)r^2 + (b + 2r)y$	$(\neq D/2)r + b + 2y$	$\frac{(\frac{D}{2} D/2)r^2 + (b + 2r)y}{(\neq D/2)r + b + 2y}$	$b + 2r$	$\frac{(\frac{D}{2} D/2)r^2}{(b + 2r)} + y$	$\frac{[(\frac{D}{2} D/2)r^2 + (b + 2r)y]^{1.5}}{\sqrt{b + 2y}}$
 Round-bottomed Triangle	$\frac{T^2}{4z} - \frac{r^2}{z} (1 - D \operatorname{arccot}^2 z)$	$\frac{T}{z} \sqrt{1 + z^2} - \frac{2r}{z} (1 - D \operatorname{arccot}^2 z)$	$\frac{A}{P}$	$2[z(y D r) + r\sqrt{1 + z^2}]$	$\frac{A}{T}$	$A \sqrt{\frac{A}{T}}$

*Satisfactory approximation for the interval 0 < x < 1, where x = 4y/T. When x > 1, use the exact expression $P = (\frac{1}{2})[\sqrt{1 + x^2} + \frac{1}{2} \ln(x + \sqrt{1 + x^2})]$

Figure 4.13
Geometric Elements of Common Sections



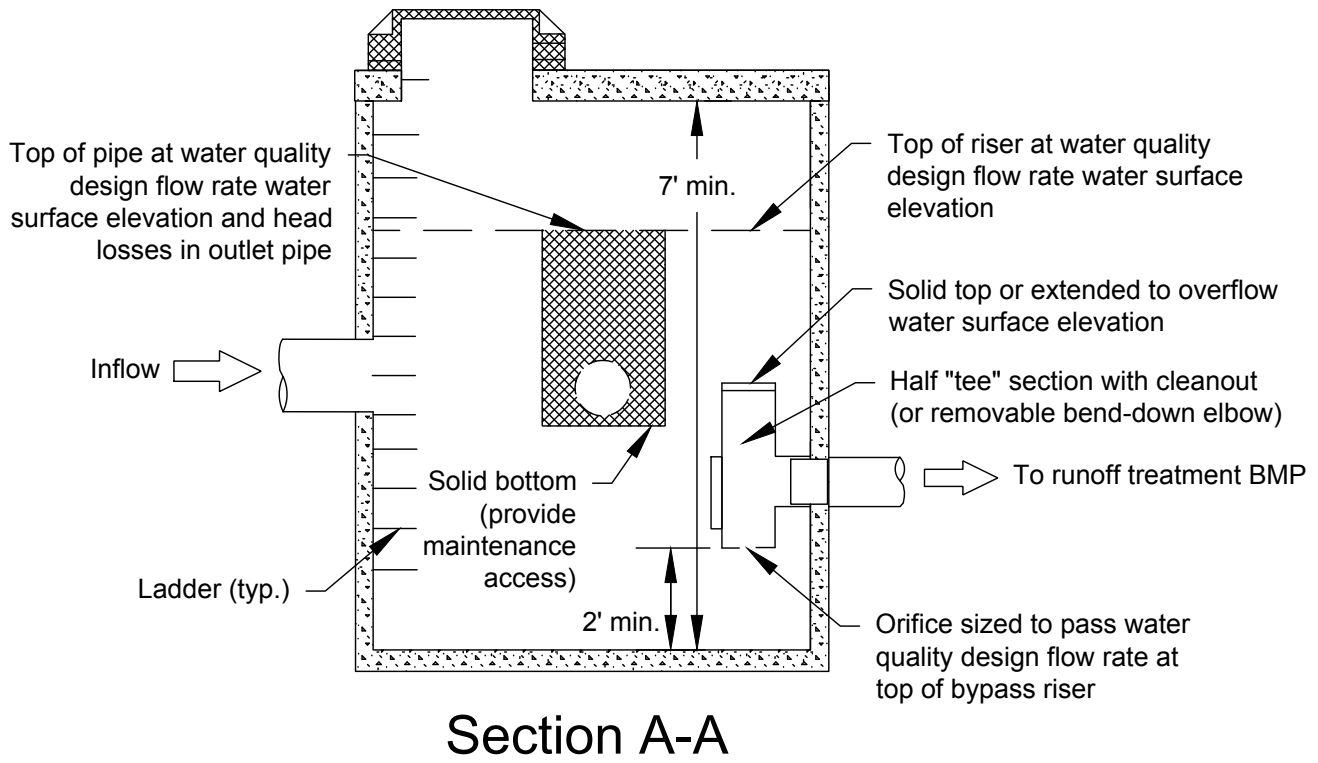
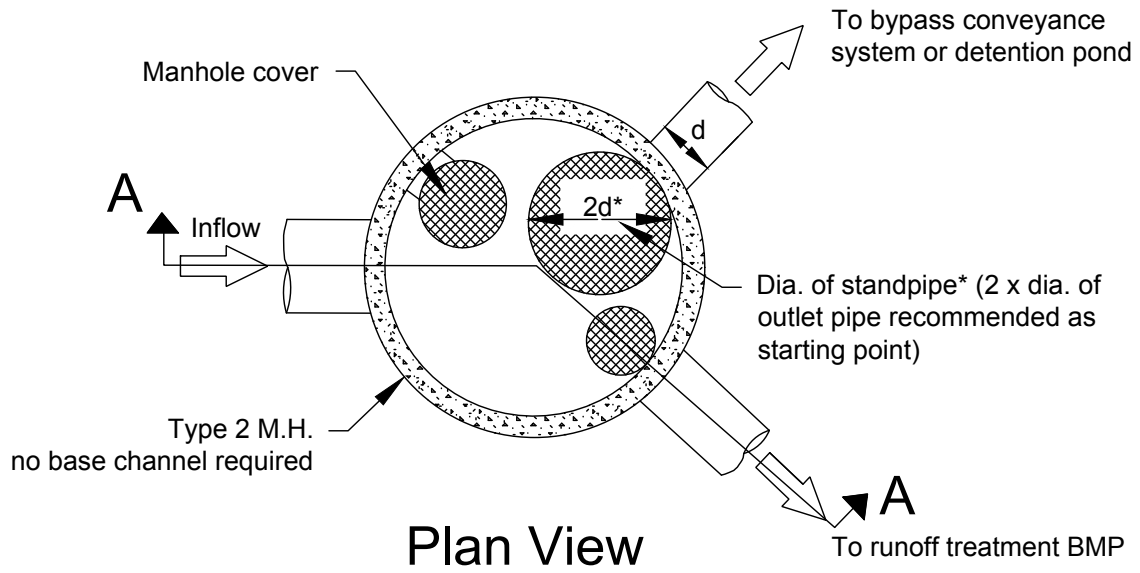
Note: The outlet pipe to the Runoff Treatment BMP may require an orifice plate installed on the outlet to control the water quality design flow rate water surface elevation (weir height). The water quality design flow rate water surface elevation should be set to provide a minimum headwater/diameter ratio of 2.0 on the outlet pipe.

NOT TO SCALE



Figure 4.14
Flow Splitter, Option A

I:\herra\local\herra\seattle\proj\1\2019\19-07028-000\CAD\Source\102419_Kitsap\Drawings\Files\from_Ecology\New with template\Fig. 14FlowSplitterOptionA.dwg



*Note: Diameter of standpipe (2d) should be large enough to minimize head above water quality design water surface and to keep water quality design flows from increasing more than 10% during 100-year flows.

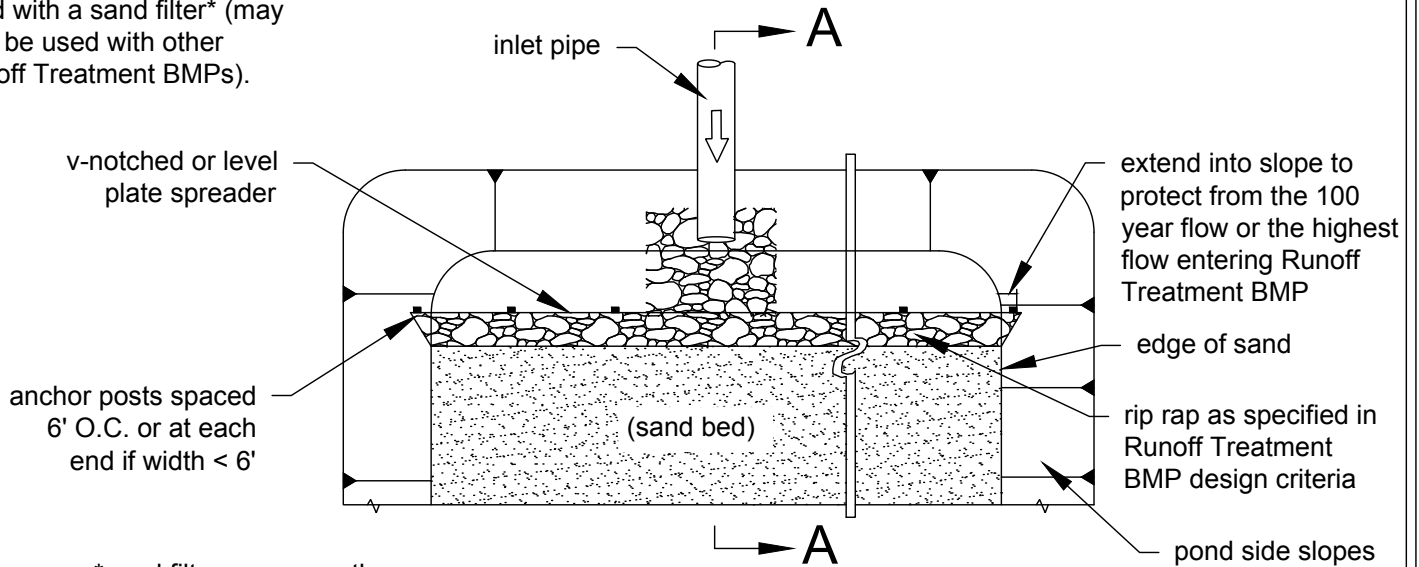
NOT TO SCALE



Figure 4.15
Flow Splitter, Option B

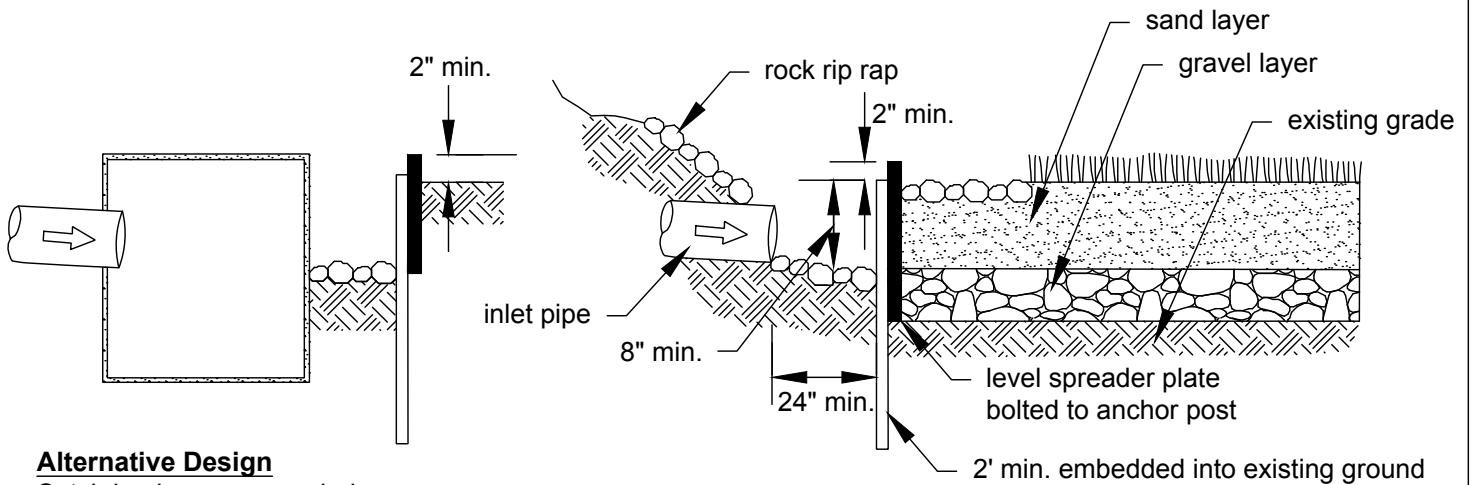
\\herraera-local\herraera\seattle\proj\1\2019\19-07028-000\CAD\Source\102419_Kitsap\Drawings Files\Files from Ecology\New with template\Fig4.15FlowSplitterOptionB.dwg

Example of anchored plate used with a sand filter* (may also be used with other Runoff Treatment BMPs).



*sand filter may use other spreading options

Plan View



Alternative Design
 Catch basin recommended for higher flow situations (generally for inflow velocities of 5 fps or greater for 100 year storm).

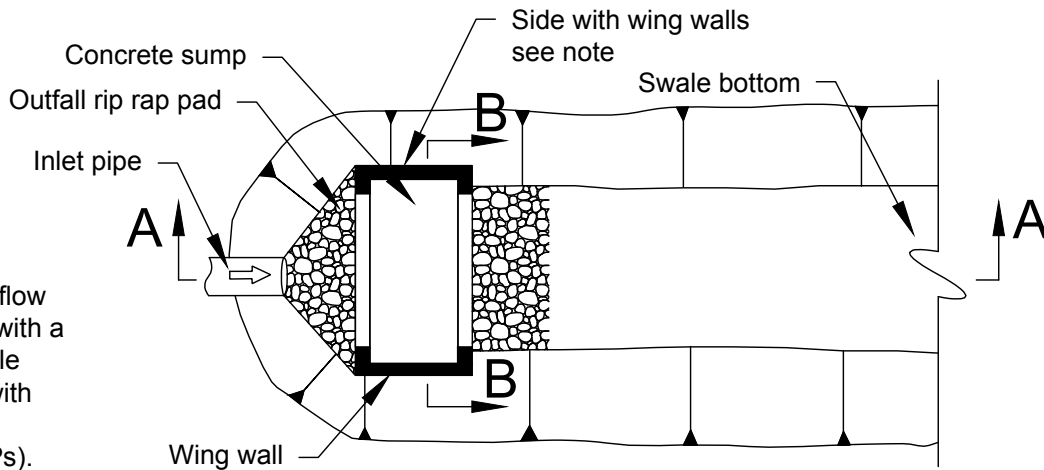
Section A-A

NOT TO SCALE



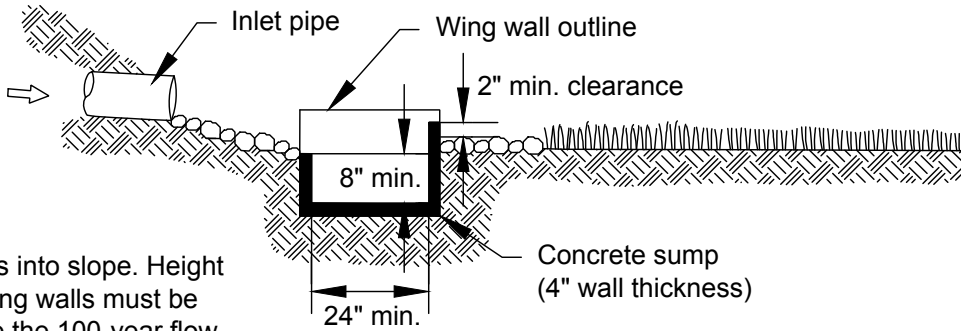
Figure 4.16
 Flow Spreader Option A: Anchored Plate

\\herra\local\herra\seattle\proj\2019\19-07028-000\CAD\Source\102419_Kitsap\Drawings\Files\16FlowSpreaderOptionA-AnchoredPlate.dwg



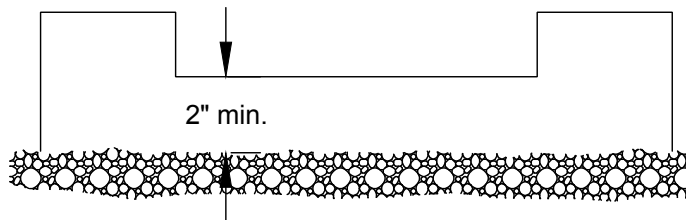
Example of a concrete sump flow spreader used with a biofiltration swale (may be used with other Runoff Treatment BMPs).

Plan View



Note: Extend sides into slope. Height of side wall and wing walls must be sufficient to handle the 100-year flow or the highest flow entering the BMP.

Section A-A



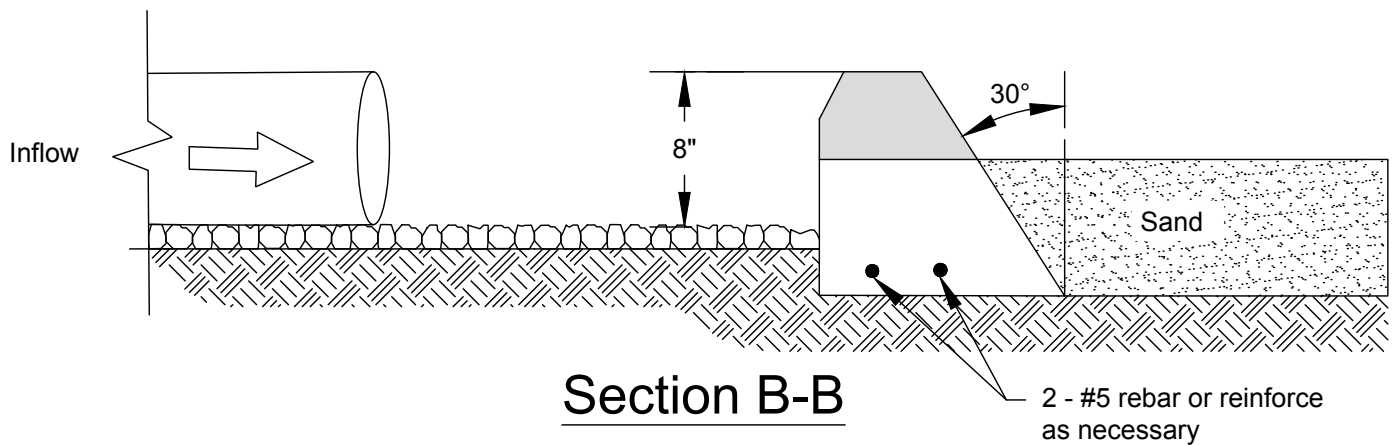
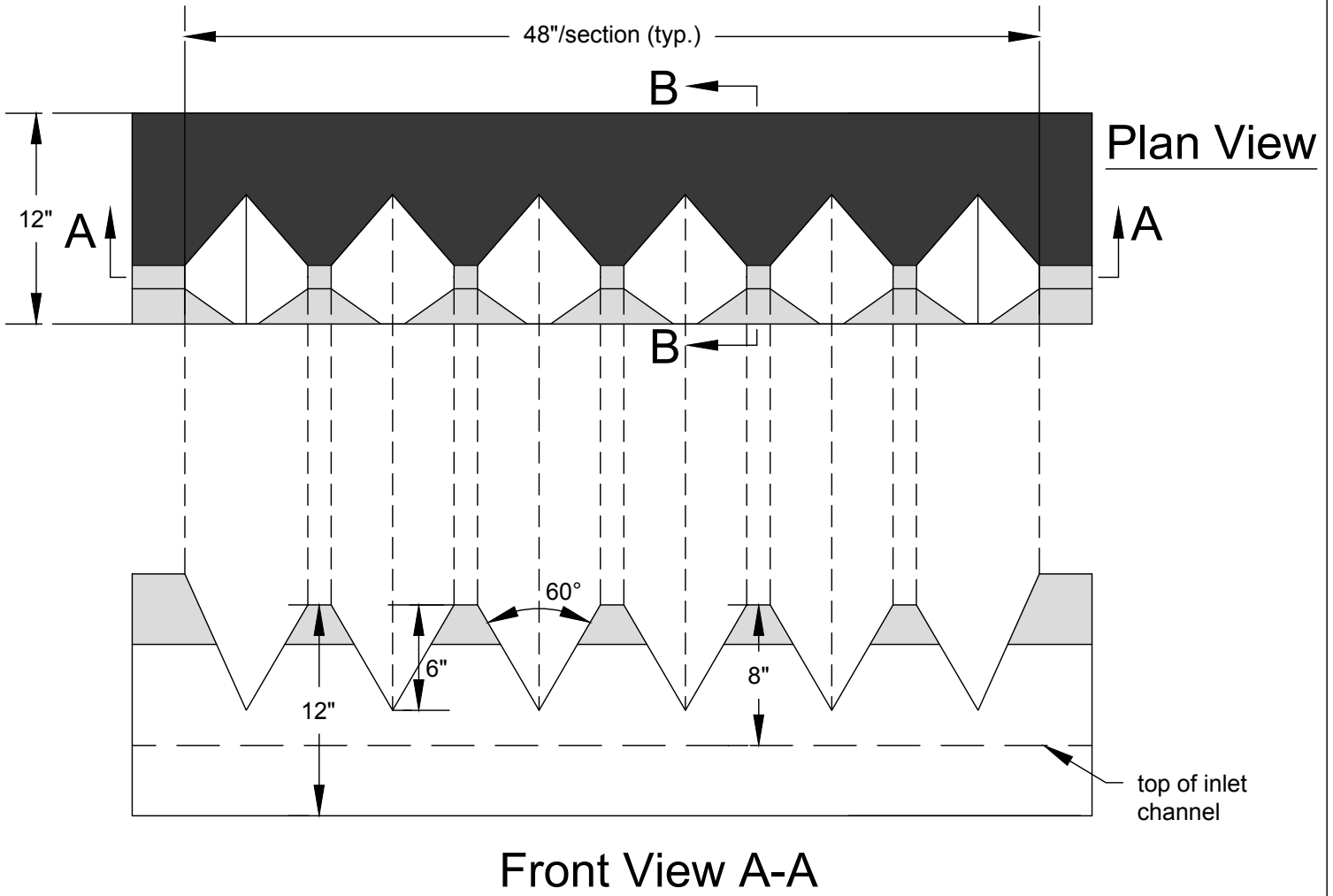
Section B-B

NOT TO SCALE



Figure 4.17
Flow Spreader Option B: Concrete Sump Box

\\herra\local\herra\herra\proj\12019\19-07028-000\CAD\DWG\Final\CAD_files\Fig4.17FlowSpreaderOptionBConcreteSumpBox.dwg



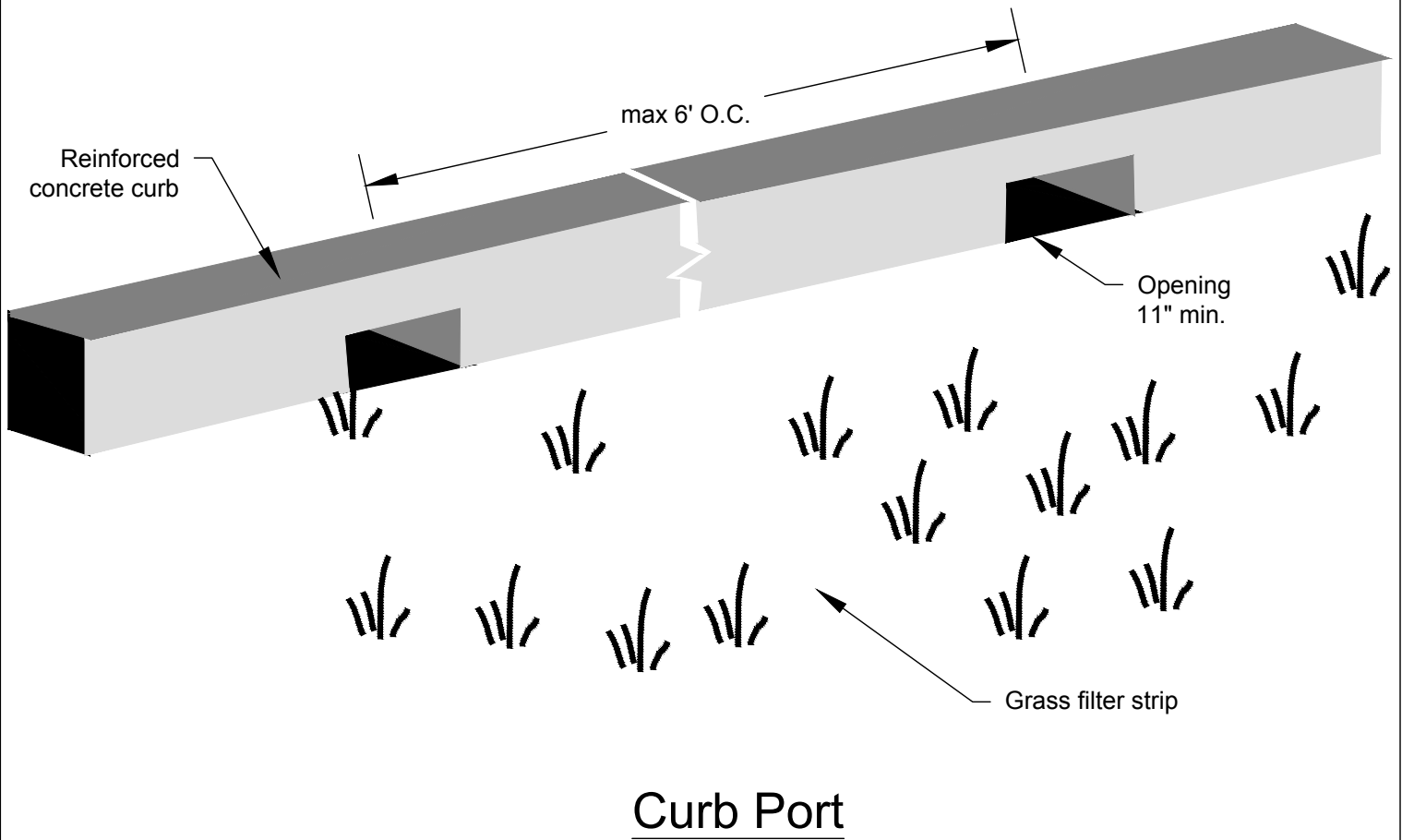
NOT TO SCALE



Figure 4.18
Flow Spreader Option C: Notched Curb Spreader

\\herraera.local\herraera\seattle\proj\19\07028-000\CAD\Drawings\Final CAD files\Fig4.18FlowSpreaderOptionC\NotchedCurbSpreader.dwg

\\herra.local\herra\proj\2019\19-07028-000\CAD\Source\102419_Kitsap\Drawings\Files\from_Ecology\New with template\Fig. 4.19 Flow Spreader Option D Through-Curb Port.dwg



NOT TO SCALE



Figure 4.19
Flow Spreader Option D: Through-Curb Port

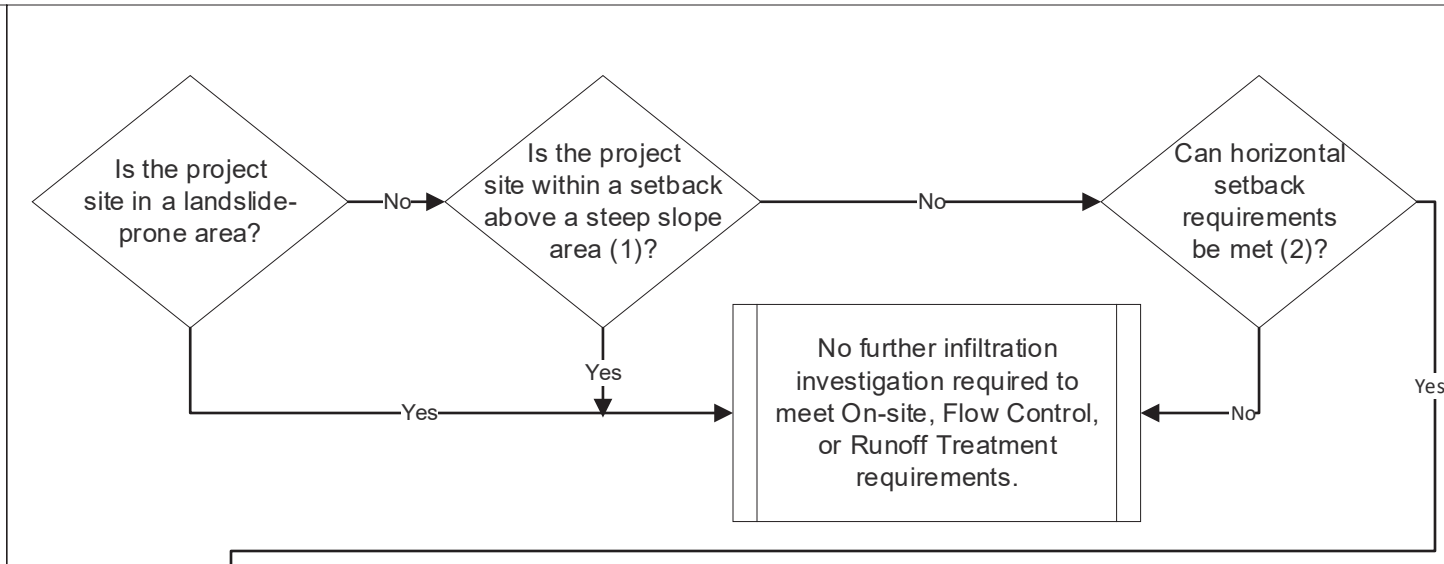
March 2020

March 2021

Figure 5.1 Infiltration Feasibility Flow Chart

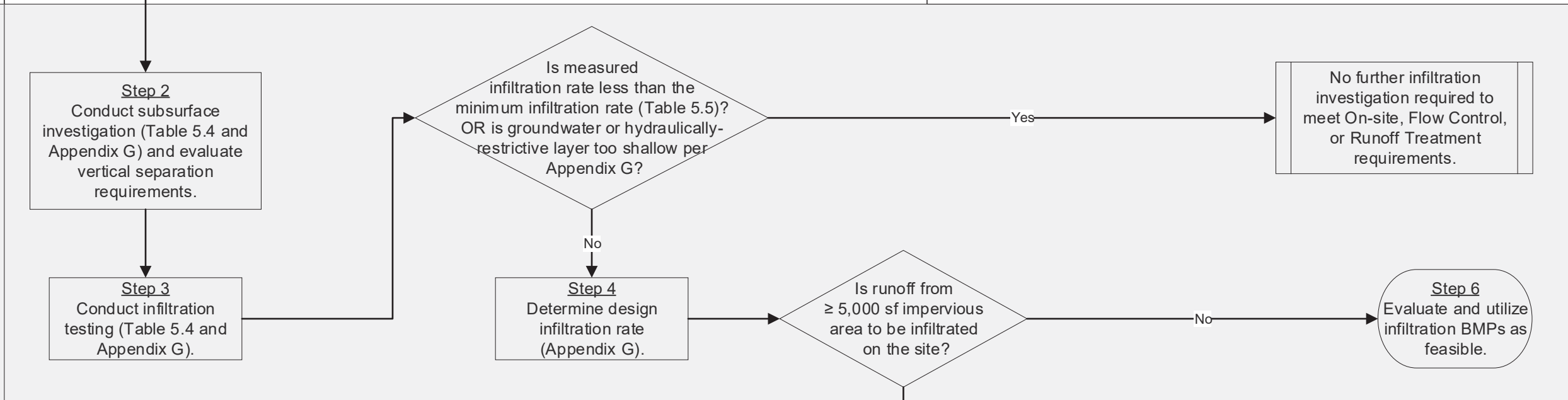


Step 1 – Evaluate horizontal setbacks & site constraints.

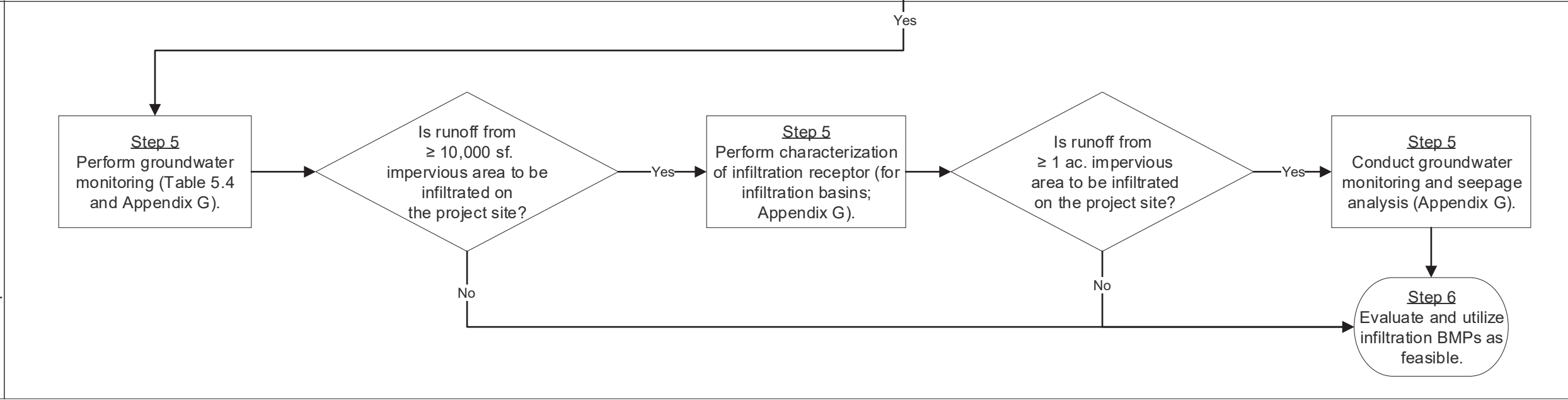


1. Setback is 10 times the height of the steep slope area to a maximum of 500 feet above a steep slope area.
2. Horizontal Setbacks include:
 - 10 feet from property lines (may be reduced from right of way with County approval)
 - 10 feet from another infiltration facility
 - 5 feet from building without basement and 10 feet from building with basement when infiltrating < 5,000 sf impervious surface
 - 5 feet from building and 10 feet from building with basement between 1H:1V slope from bottom of BMP when infiltrating ≥ 5,000 sf impervious surface
 - 100 feet of a contaminated site or landfill (active or closed)
 - Where soil and/or groundwater containment problems have been identified
 - Within groundwater protection area
 - 10 feet from petroleum, chemical or hazardous waste storage tank of 1,100 gallons or less
 - 100 feet from petroleum, chemical or hazardous waste storage tank > 1,100 gallons
 - ~~100 feet from drinking water wells, septic tanks, and drain fields~~
 - 100 feet from open water features and designated landslide hazards
 - 200 feet from springs and flowing artesian wells used for drinking water supply. Infiltration BMPs upgradient of drinking water supplies shall comply with Health Department requirements
 - 50 feet from the top of any slope over 20%
 - See Table 5-1 for Horizontal Setback requirements for on-site systems
 - See Table 5-2 for Horizontal Setback requirements for private/public wells

Step 2 – Conduct subsurface investigation and evaluate vertical separation requirements.
Step 3 – Conduct infiltration testing.
Step 4 – Determine design infiltration rate.



Step 5 – Conduct groundwater monitoring, receptor characterization, mounding and seepage analysis, and infiltration testing for permeable pavements and surfaces.
Step 6 – Evaluate use of infiltration to meet minimum requirements.



Note: This flow chart does not include all Runoff Treatment BMP options. Review the text in Volume II, Section 5.3.4 for all options for each Runoff Treatment Performance Goal.

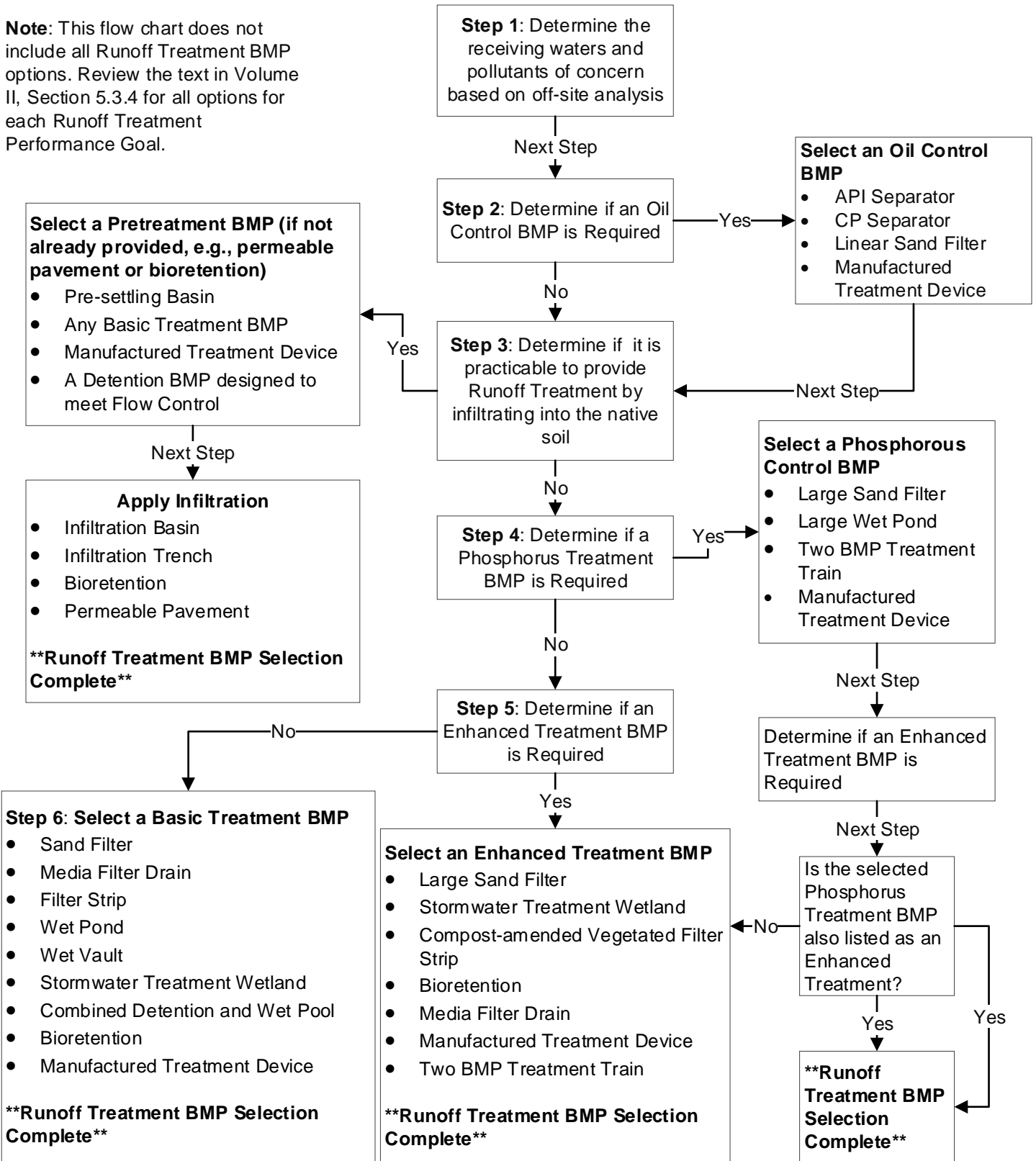


Figure 5.2
Runoff Treatment BMP
Selection Flow Chart

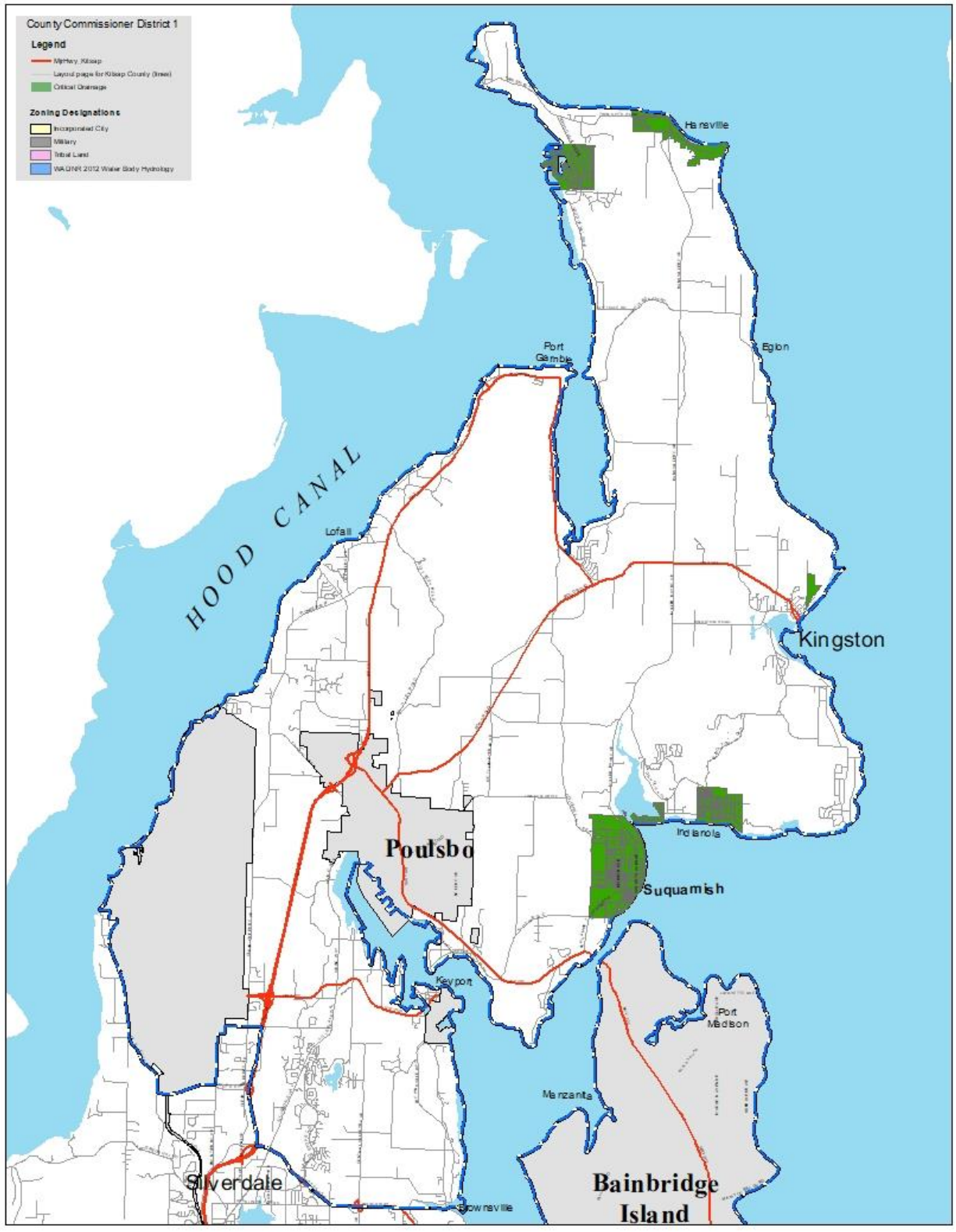


Figure 8.1
 Critical Drainage Areas
 Commissioner District 1

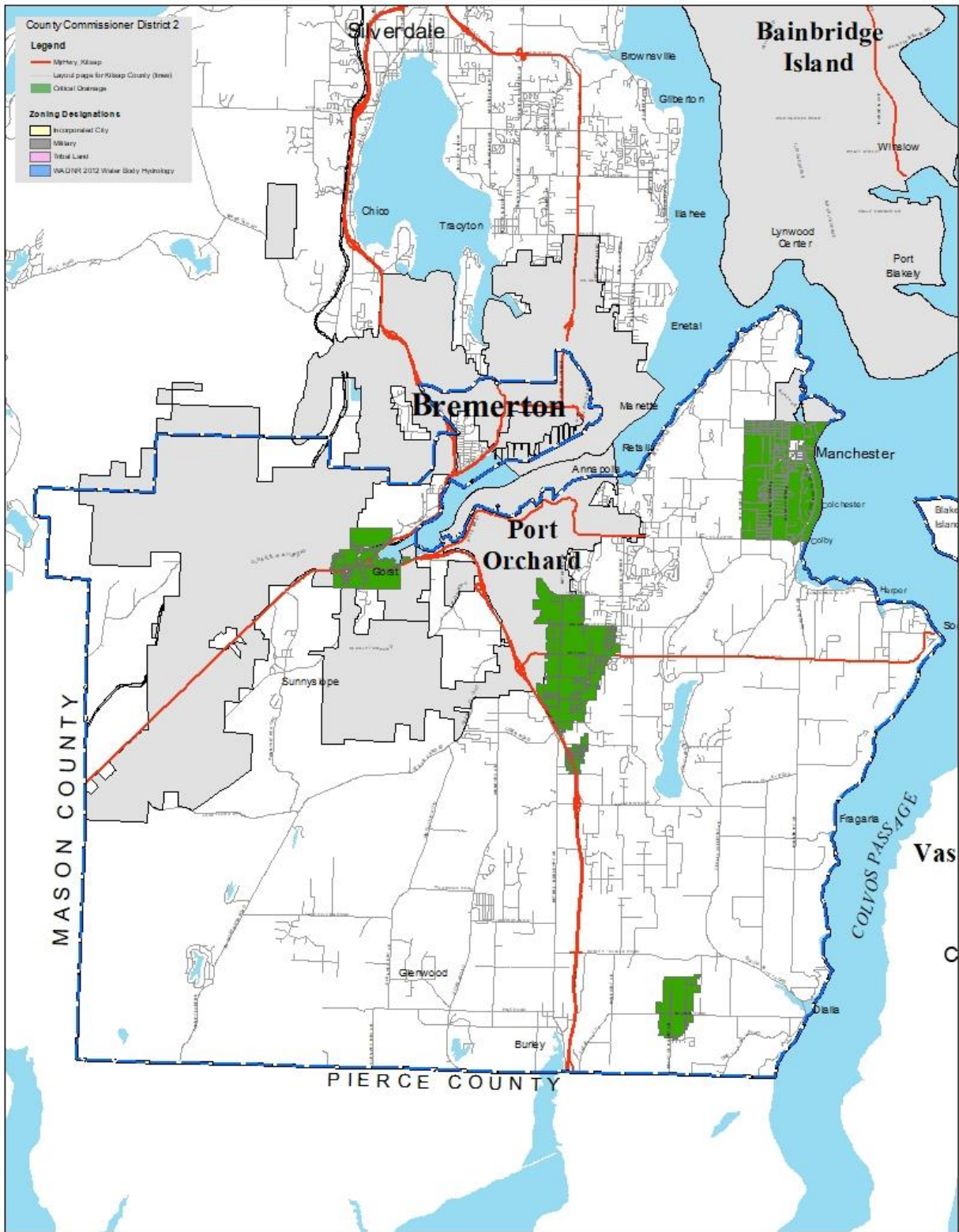


Figure 8.2
 Critical Drainage Areas
 Commissioner District 2

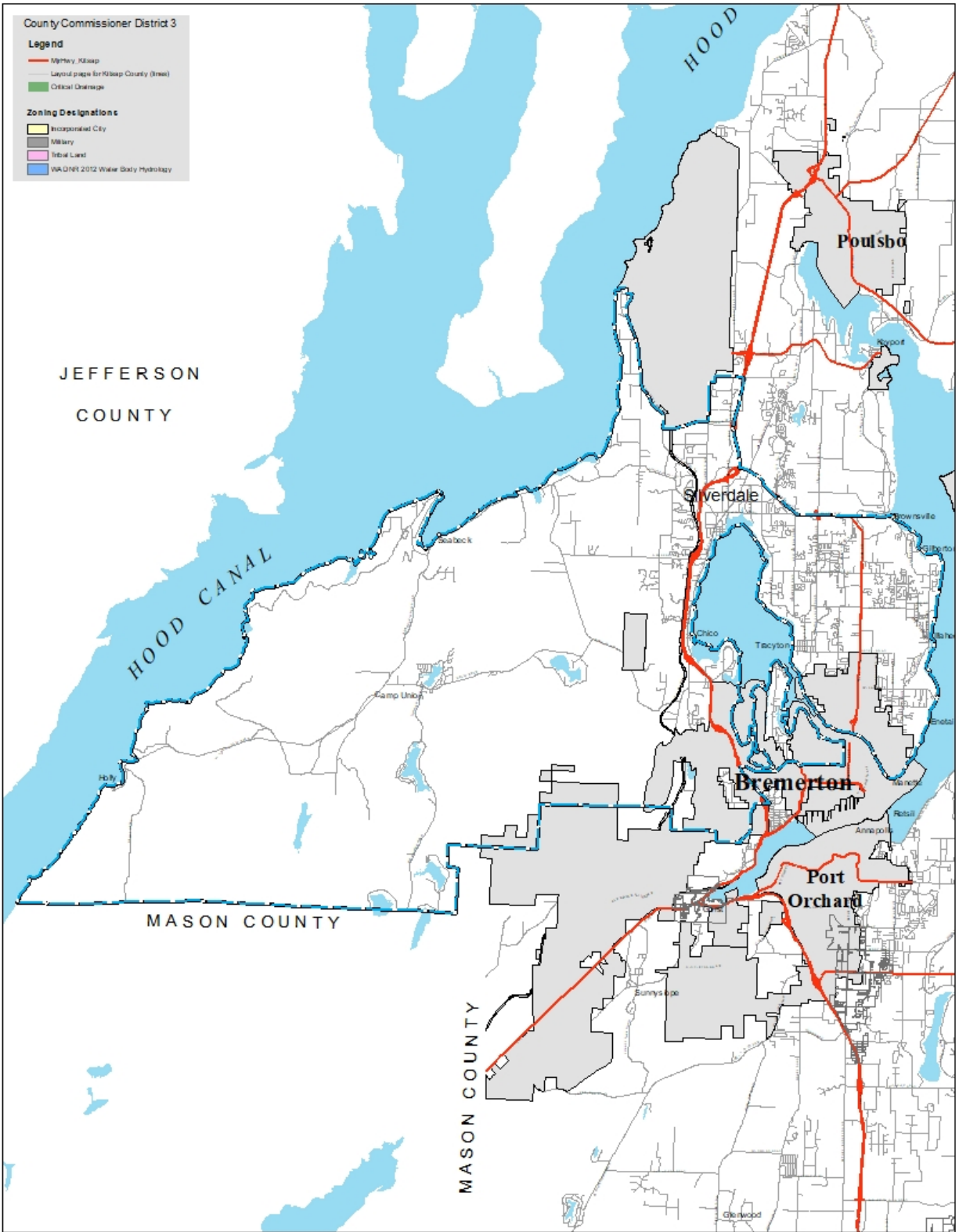
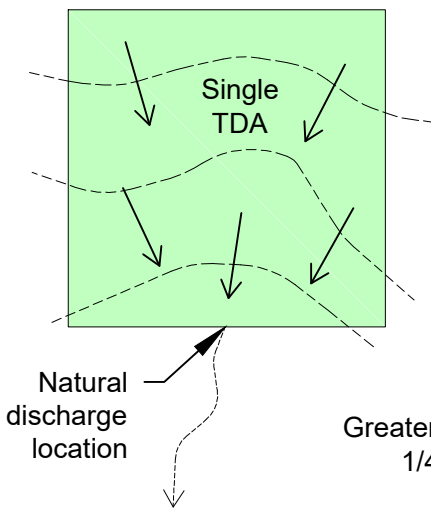


Figure 8.3
 Critical Drainage Areas
 Commissioner District 3

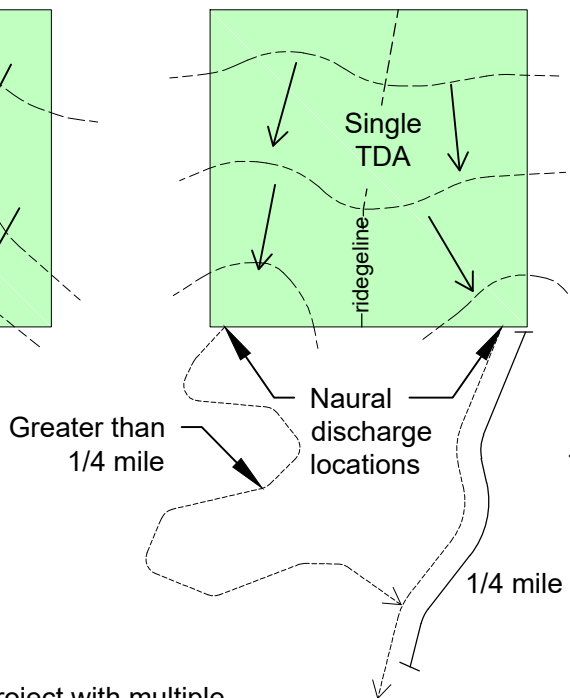


Appendix A Figures

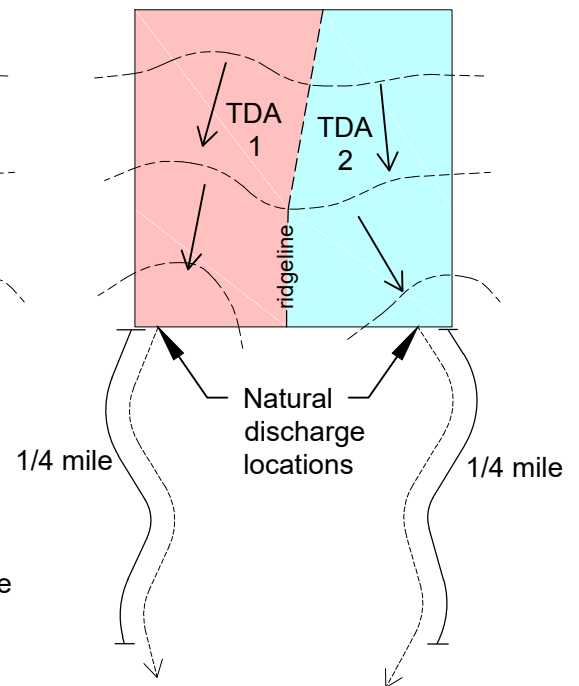
Example of a Project Site with a single natural discharge and a single TDA



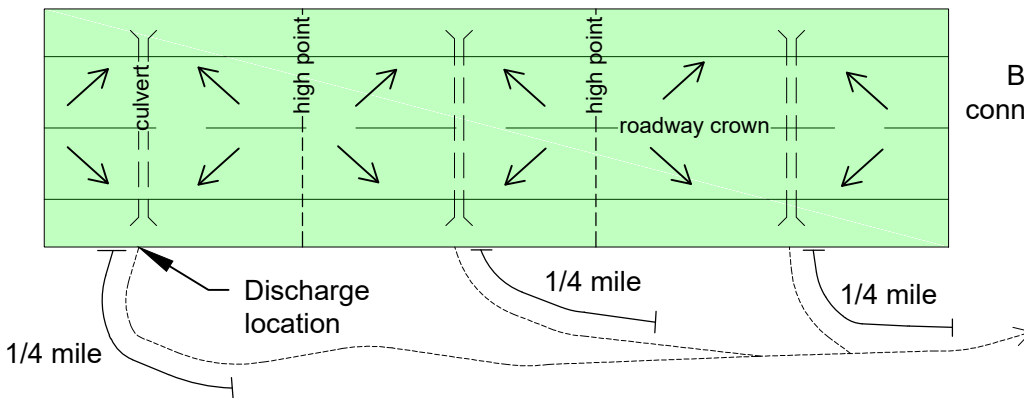
Example of a Project Site with multiple natural discharges and a single TDA



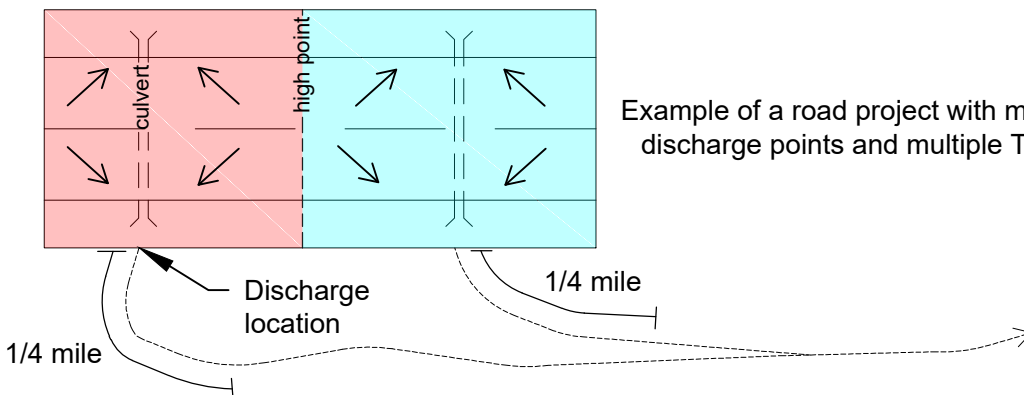
Example of a Project Site with multiple natural discharges and multiple TDAs



Example of a road project with multiple discharge points and a single TDA



Because the right-most discharge connects to the other two discharge flow paths within 1/4 mile, all areas are connected as one TDA.



Note: Shaded areas represent the limites of the project site.

NOT TO SCALE



Figure A-1
Example TDA Delineations

Appendix F Figures

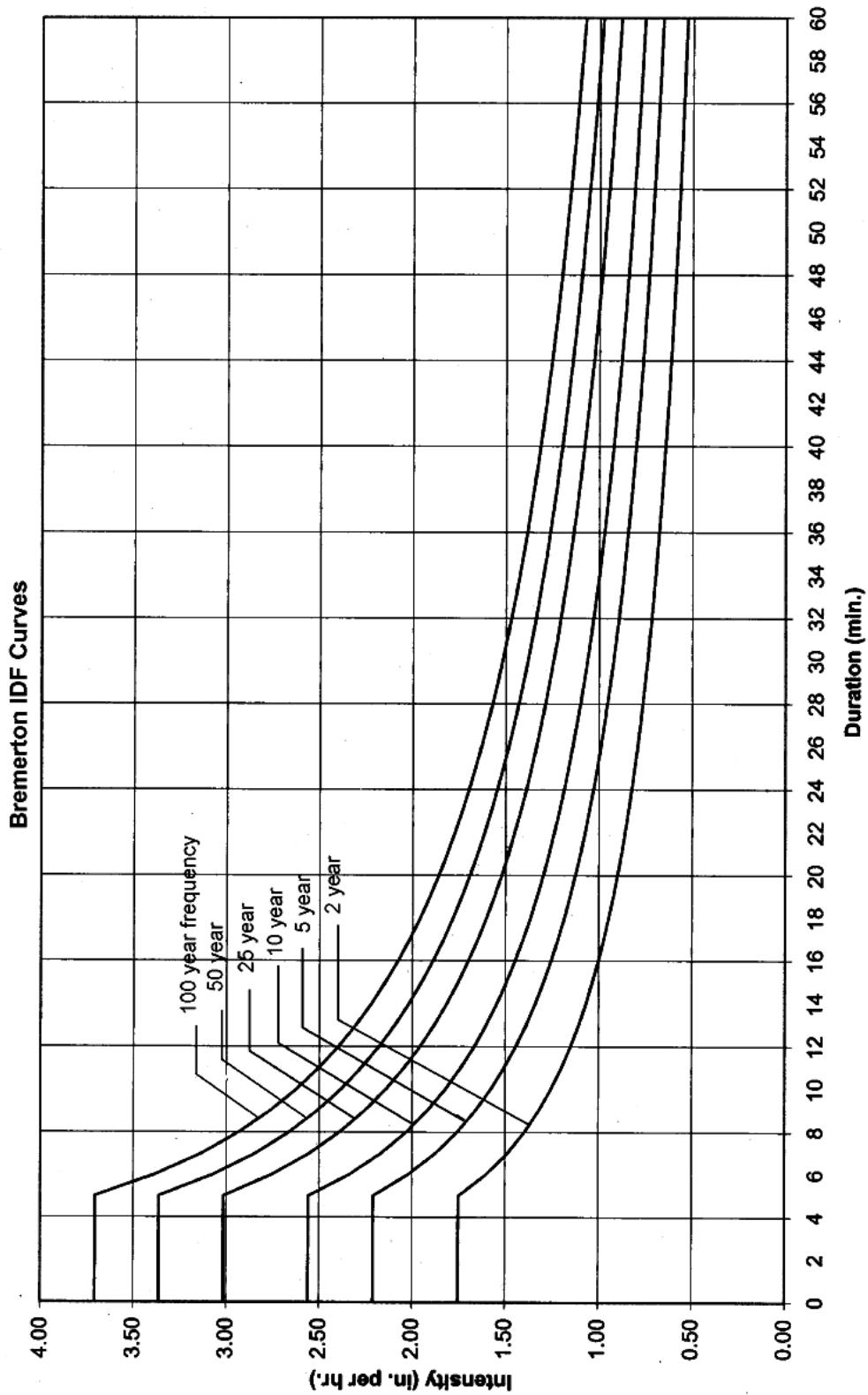


Figure F.1
Rainfall Intensity-Duration
Curves

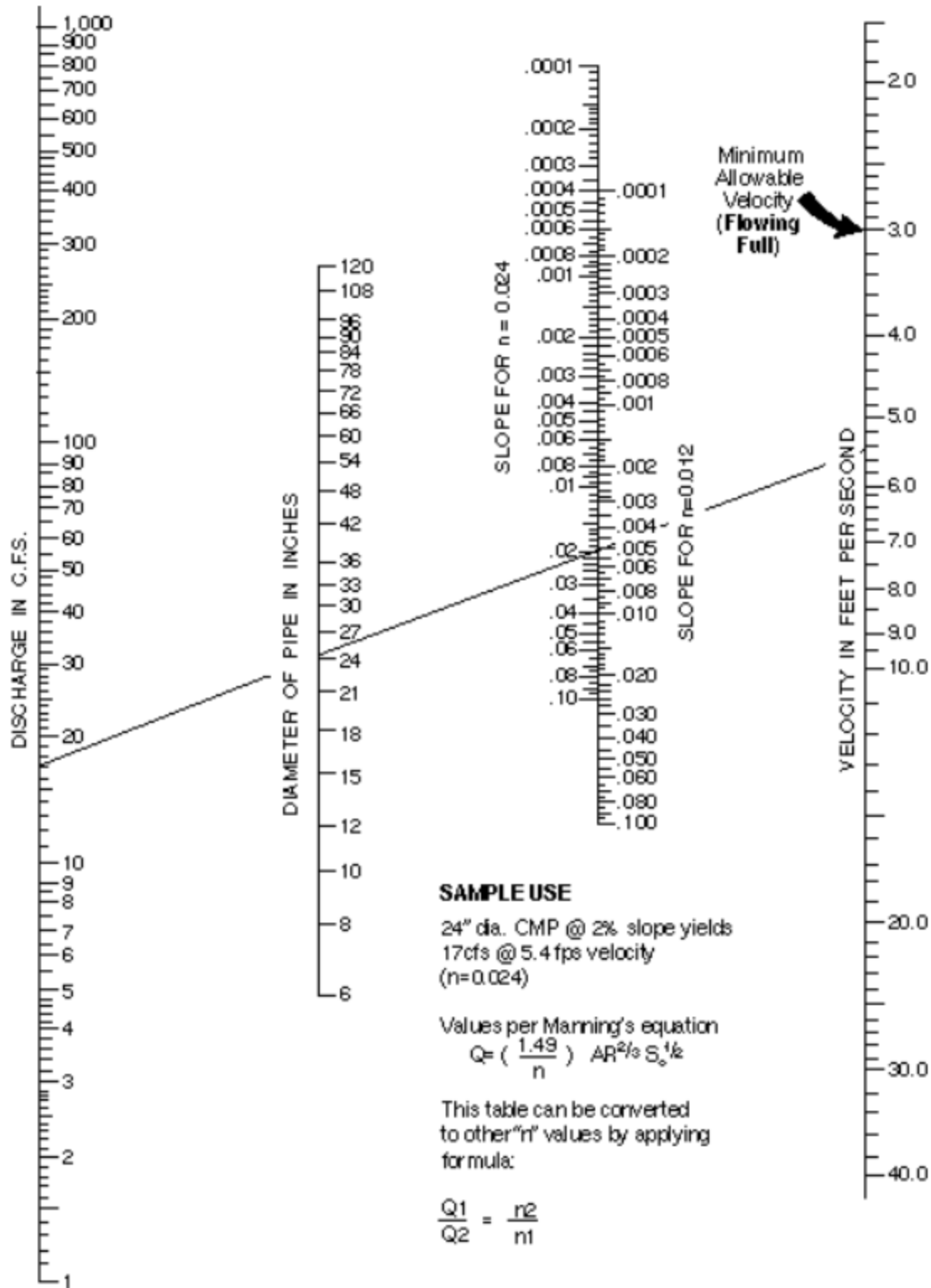


Figure F.2
 Nomograph for Sizing Circular
 Drains Flowing Full

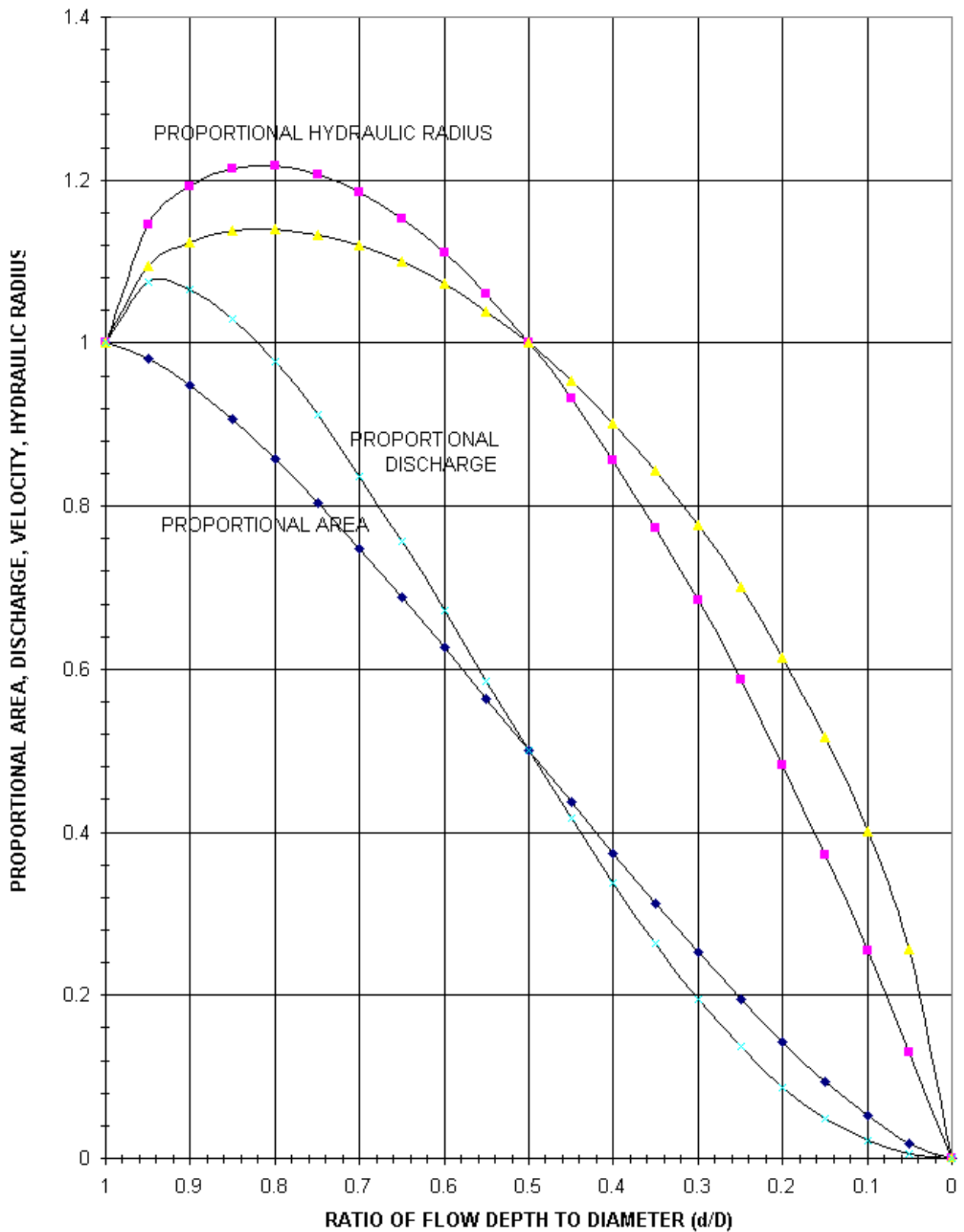


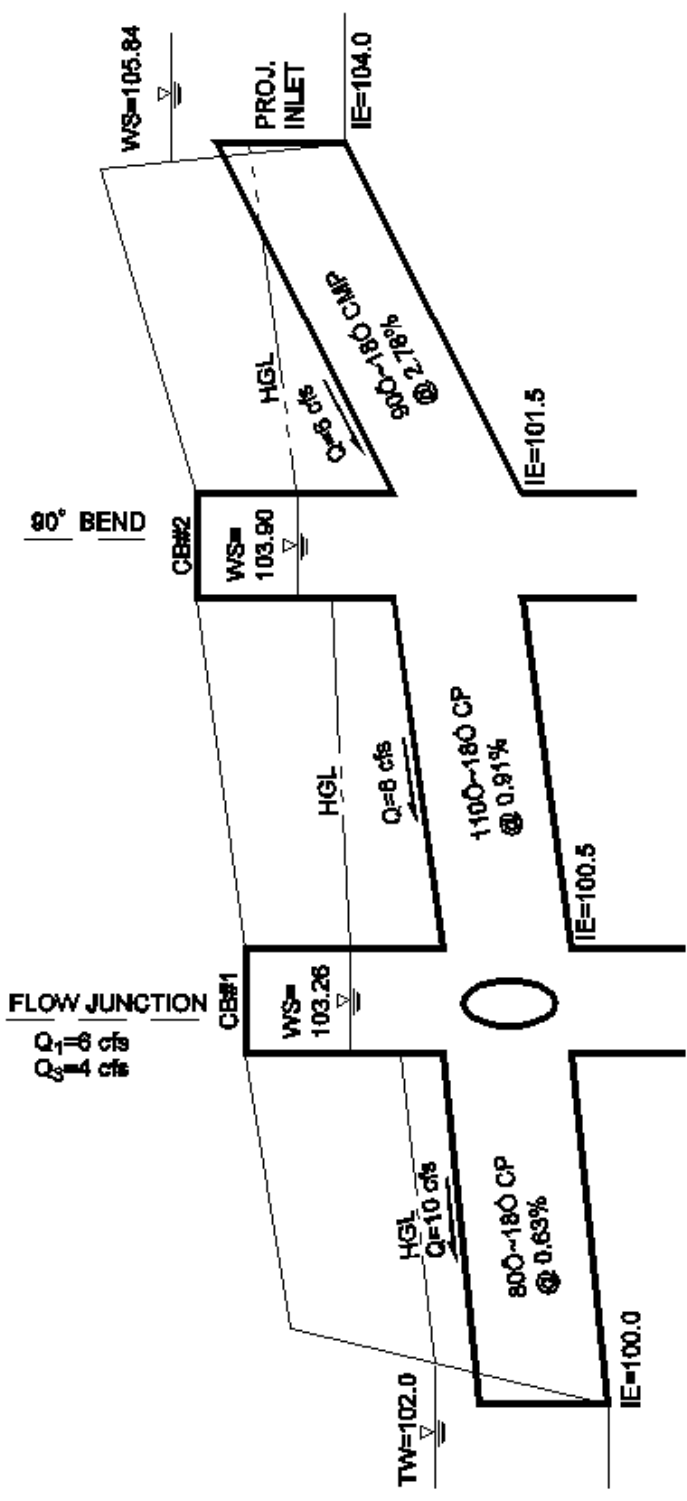
Figure F.3
Circular Channel Ratios

- Column (1) - Design flow to be conveyed by pipe segment.
- Column (2) - Length of pipe segment.
- Column (3) - Pipe Size; indicate pipe diameter or span x rise.
- Column (4) - Manning's "n" value.
- Column (5) - Outlet Elevation of pipe segment.
- Column (6) - Inlet Elevation of pipe segment.
- Column (7) - Barrel Area; this is the full cross-sectional area of the pipe.
- Column (8) - Barrel Velocity; this is the full velocity in the pipe as determined by:
- $$V = Q/A \text{ or } \text{Col.}(8) = \text{Col.}(1) / \text{Col.}(7)$$
- Column (9) - Barrel Velocity Head = $V^2/2g$ or $(\text{Col.}(8))^2/2g$
where $g = 32.2 \text{ ft/sec}^2$ (acceleration due to gravity)
- Column (10) - Tailwater (TW) Elevation; this is the water surface elevation at the outlet of the pipe segment. If the pipe's outlet is not submerged by the TW and the TW depth is less than $(D+d_c)/2$, set TW equal to $(D+d_c)/2$ to keep the analysis simple and still obtain reasonable results (D = pipe barrel height and d_c = critical depth, both in feet. See Figure F.14 for determination of d_c).
- Column (11) - Friction Loss = $S_f \times L$ [or $S_f \times \text{Col.}(2)$]
where S_f is the friction slope or head loss per linear foot of pipe as determined by Manning's equation expressed in the form:
- $$S_f = (nV)^2/2.22 R^{4.49}$$
- Column (12) - Hydraulic Grade Line (HGL) Elevation just inside the entrance of the pipe barrel; this is determined by adding the friction loss to the TW elevation:
- $$\text{Col.}(12) = \text{Col.}(11) + \text{Col.}(10)$$
- If this elevation falls below the pipe's inlet crown, it no longer represents the true HGL when computed in this manner. The true HGL will fall somewhere between the pipe's crown and either normal flow depth or critical flow depth, whichever is greater. To keep the analysis simple and still obtain reasonable results (i.e., erring on the conservative side), set the HGL elevation equal to the crown elevation.
- Column (13) - Entrance Head Loss = $K_e \times V^2/2g$ [or $K_e \times \text{Col.}(9)$]
where K_e = Entrance Loss Coefficient (from Table F.4). This is the head lost due to flow contractions at the pipe entrance.
- Column (14) - Exit Head Loss = $1.0 \times V^2/2g$ or $1.0 \times \text{Col.}(9)$
This is the velocity head lost or transferred downstream.
- Column (15) - Outlet Control Elevation = $\text{Col.}(12) + \text{Col.}(13) + \text{Col.}(14)$
This is the maximum headwater elevation assuming the pipe's barrel and inlet/outlet characteristics are controlling capacity. It does not include structure losses or approach velocity considerations.
- Column (16) - Inlet Control Elevation (see Appendix F for computation of inlet control on culverts); this is the maximum headwater elevation assuming the pipe's inlet is controlling capacity. It does not include structure losses or approach velocity considerations.
- Column (17) - Approach Velocity Head; this is the amount of head/energy being supplied by the discharge from an upstream pipe or channel section, which serves to reduce the headwater elevation. If the discharge is from a pipe, the approach velocity head is equal to the barrel velocity head computed for the upstream pipe. If the upstream pipe outlet is significantly higher in elevation (as in a drop manhole) or lower in elevation such that its discharge energy would be dissipated, an approach velocity head of zero should be assumed.
- Column (18) - Bend Head Loss = $K_b \times V^2/2g$ [or $K_b \times \text{Col.}(17)$]
where K_b = Bend Loss Coefficient (from Figure F.7). This is the loss of head/energy required to change direction of flow in an access structure.
- Column (19) - Junction Head Loss. This is the loss in head/energy that results from the turbulence created when two or more streams are merged into one within the access structure. Figure F.8 may be used to determine this loss, or it may be computed using the following equations derived from Figure F.8:
- $$\text{Junction Head Loss} = K_j \times V^2/2g \text{ [or } K_j \times \text{Col.}(17)\text{]}$$
- where K_j is the Junction Loss Coefficient determined by:
- $$K_j = (Q_3/Q_1)/(1.18 + 0.63(Q_3/Q_1))$$
- Column (20) - Headwater (HW) Elevation; this is determined by combining the energy heads in Columns 17, 18, and 19 with the highest control elevation in either Column 15 or 16, as follows:
- $$\text{Col.}(20) = \text{Col.}(15 \text{ or } 16) - \text{Col.}(17) + \text{Col.}(18) + \text{Col.}(19)$$



Figure F.5 Backwater Calculation Sheet Notes

March 2021



BACKWATER CALCULATION SHEET

Pipe Segment CB to CB	Q (cfs)	(1)	(2)	(3)	(4)	(5)	(6)	(7)	(8)	(9)	(10)	(11)	(12)	(13)	(14)	(15)	(16)	(17)	(18)	(19)	(20)
		Length (ft)	Pipe Size	Orific Value	Outlet Elev (ft)	Inlet Elev (ft)	Barrel Area (sqft)	Barrel Vel (ft/s)	Barrel Vel Head (ft)	Friction Loss (ft)	TV Elev (ft)	Entr. Loss (ft)	Entr. HGL Elev (ft)	Entr. Loss (ft)	Exit Head Loss (ft)	Contr. Elev (ft)	Contr. Elev (ft)	Appr. Vel Head Loss (ft)	Bend Head Loss (ft)	Junc Head Loss (ft)	HW Elev (ft)
1	10	80	180	0.012	100.00	100.50	1.77	5.66	0.50	0.62	102.00	0.62	102.62	0.25	0.50	103.37	102.75	-0.18	0.002	0.07	103.26
2	6	110	180	0.012	100.50	101.50	1.77	3.38	0.16	0.31	103.26	0.31	103.57	0.08	0.16	103.84	102.95	-0.18	0.24	0.0	103.90
Inlet	6	90	180	0.024	101.50	104.00	1.77	3.38	0.18	1.00	103.90	1.00	104.90	0.18	0.18	105.84	105.60	-0.0	0.0	0.0	105.84



Figure F.6
Backwater Pipe Calculation
Example

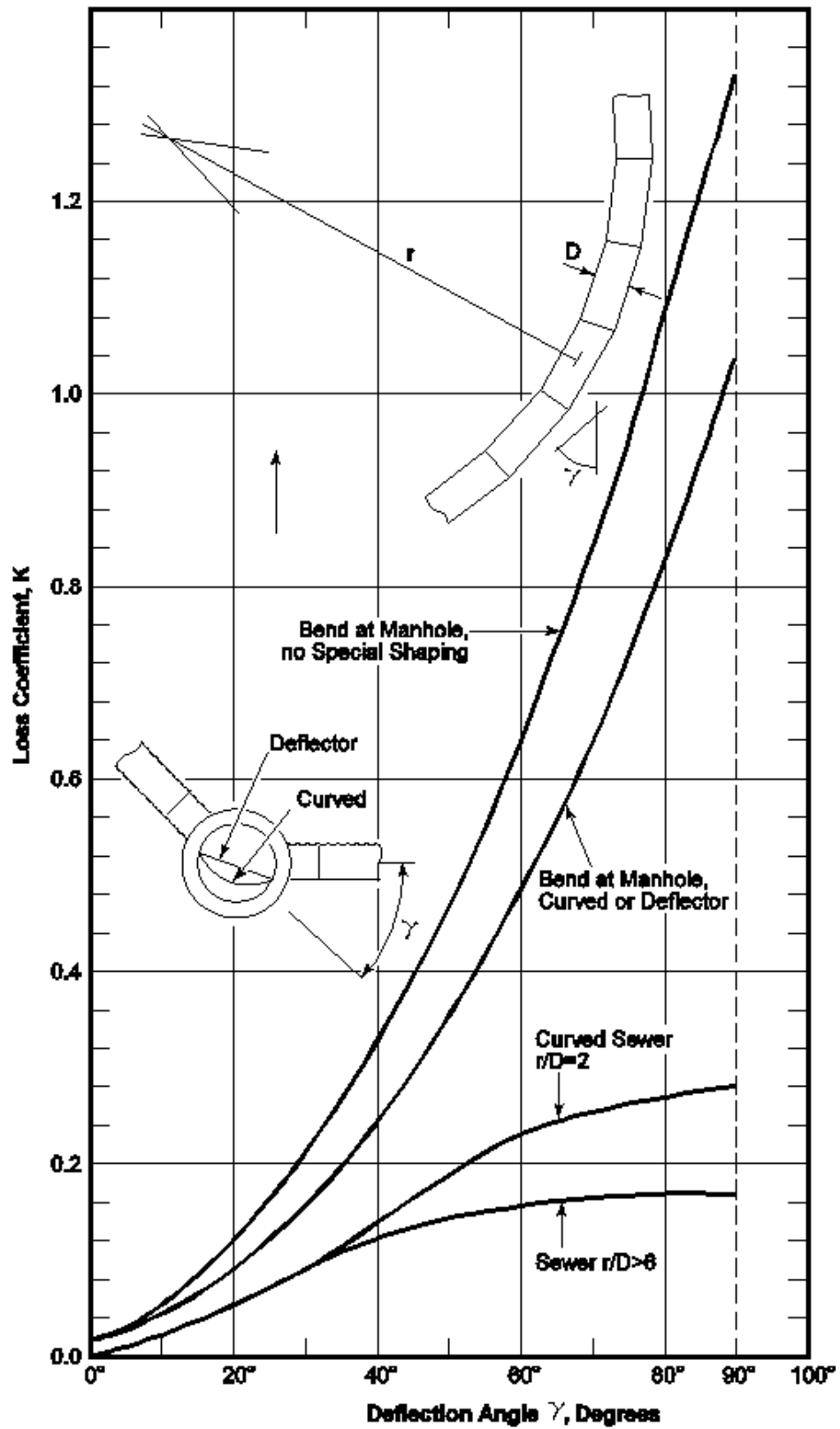
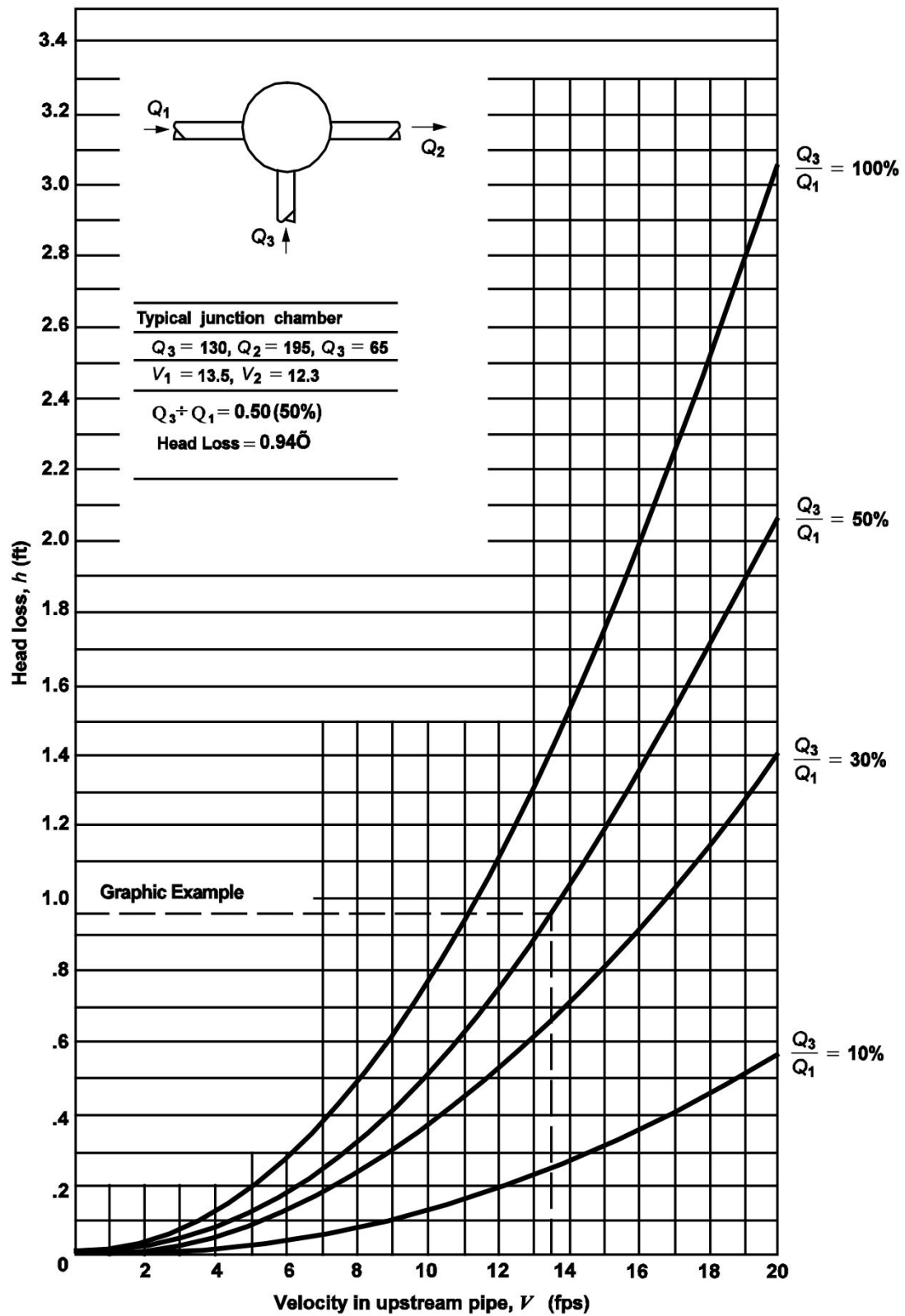


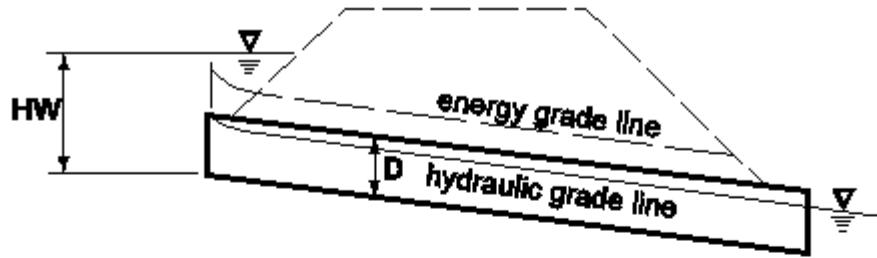
Figure F.7
Bend Head Losses in Structure



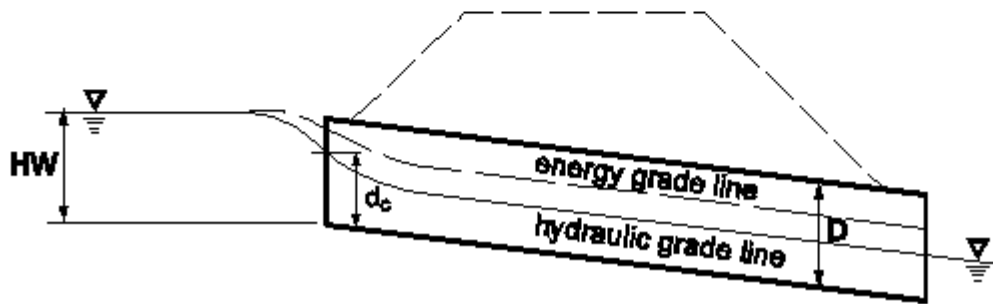
Source: Baltimore County Department of Public Works; King County 2016 SDM



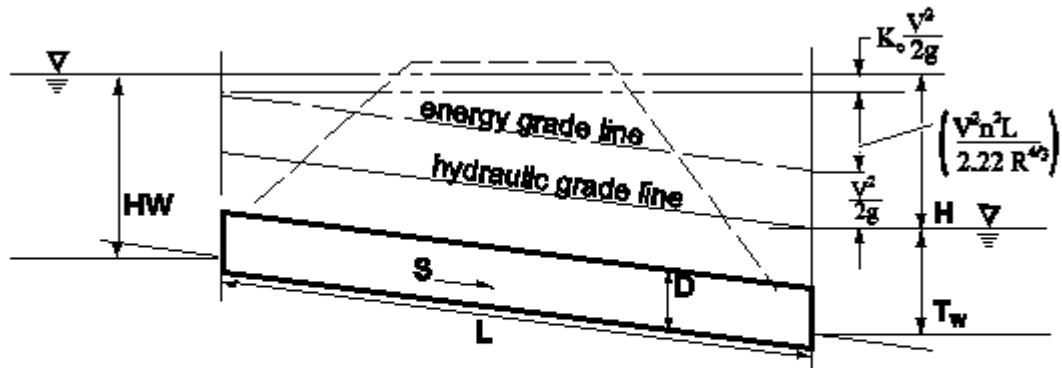
Figure F.8
Junction Head Loss in Structure



Inlet Control - Submerged Inlet



Inlet Control - Unsubmerged Inlet



Outlet Control - Submerged Inlet and Outlet

NOTE: See FHWA no. 5 for other possible conditions



Figure F.9
Inlet/Outlet Control Conditions

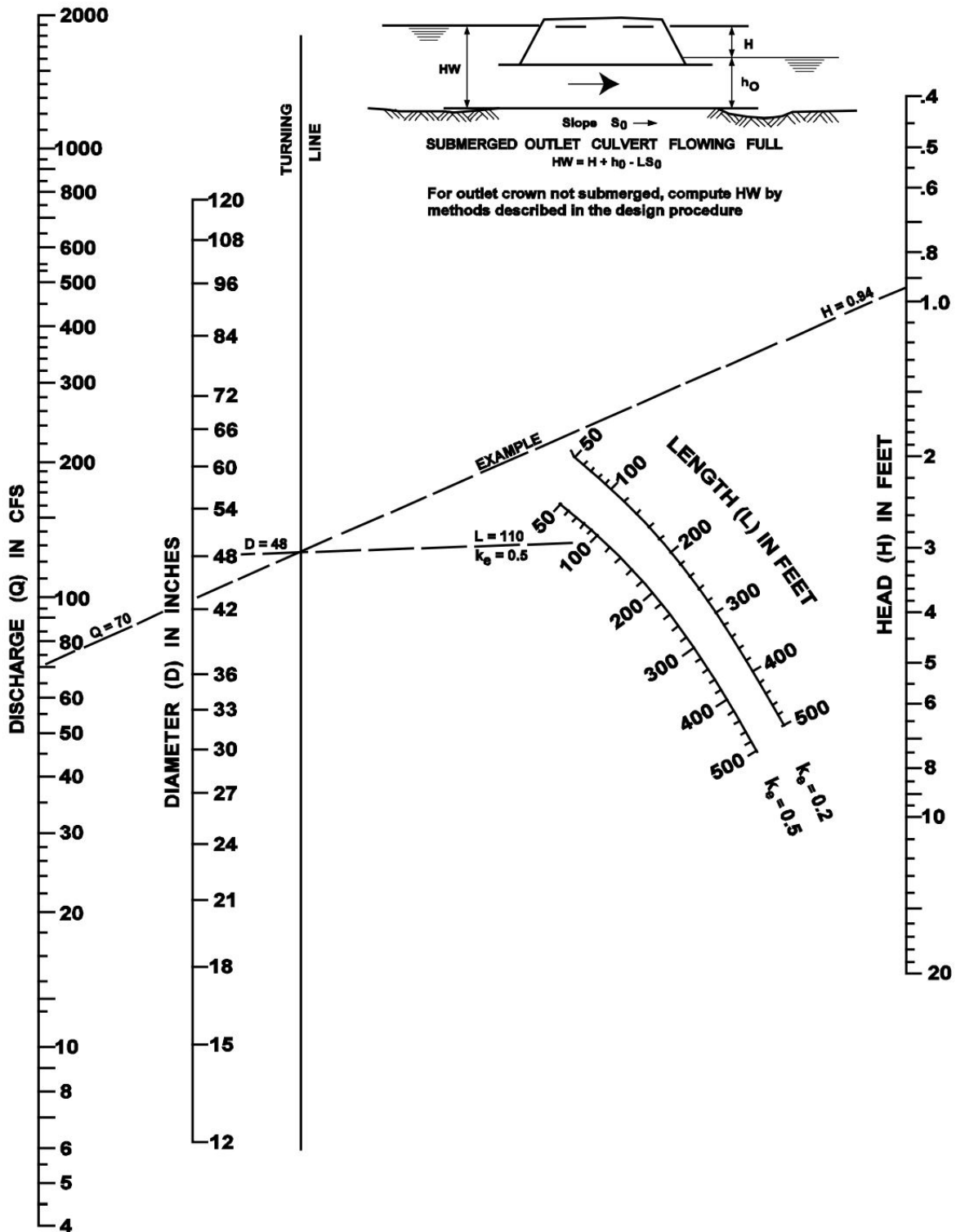


Figure F.10
 Head for Culverts (Pipe with $n=0.012$) Flowing Full with Outlet Control

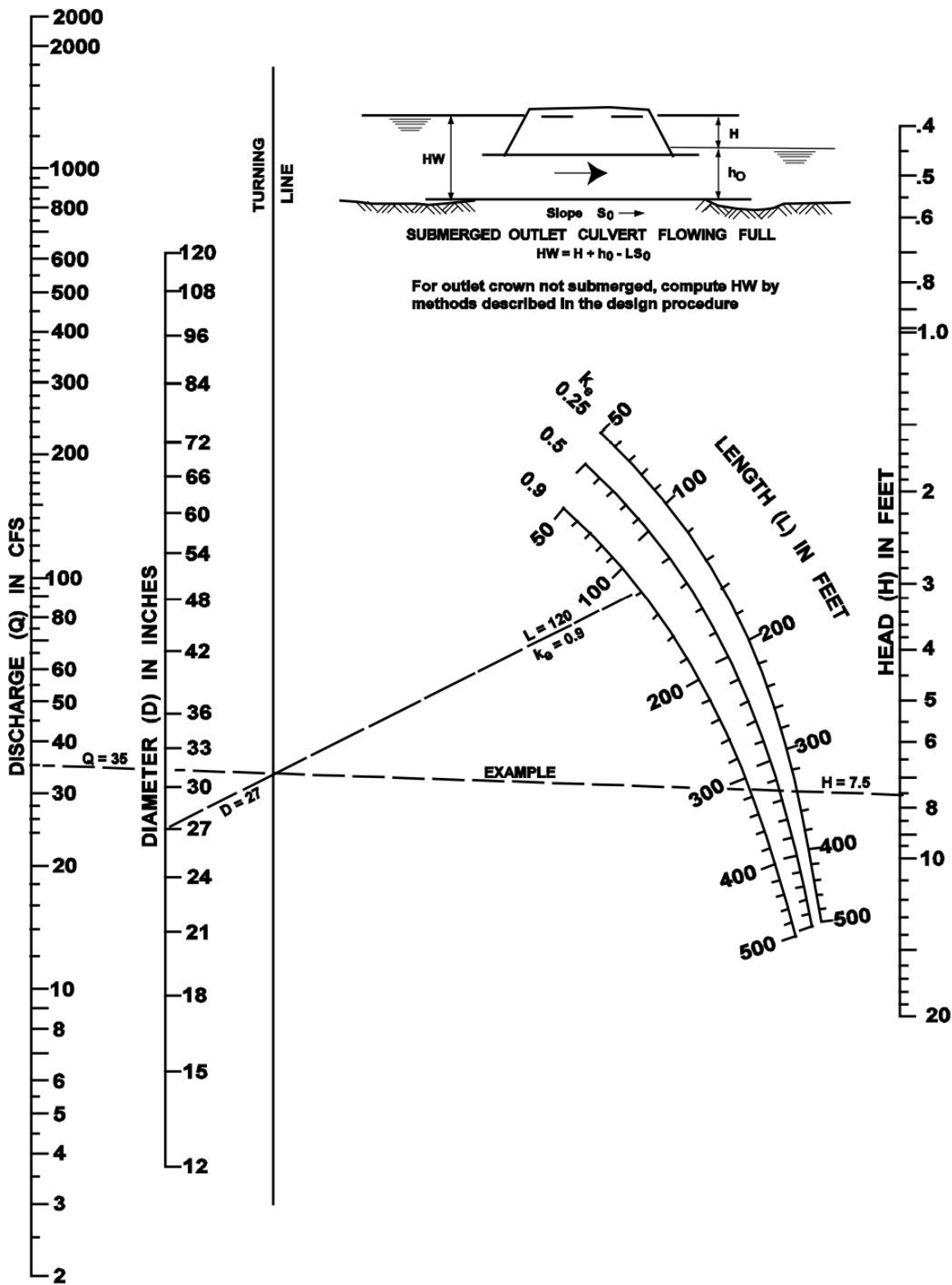
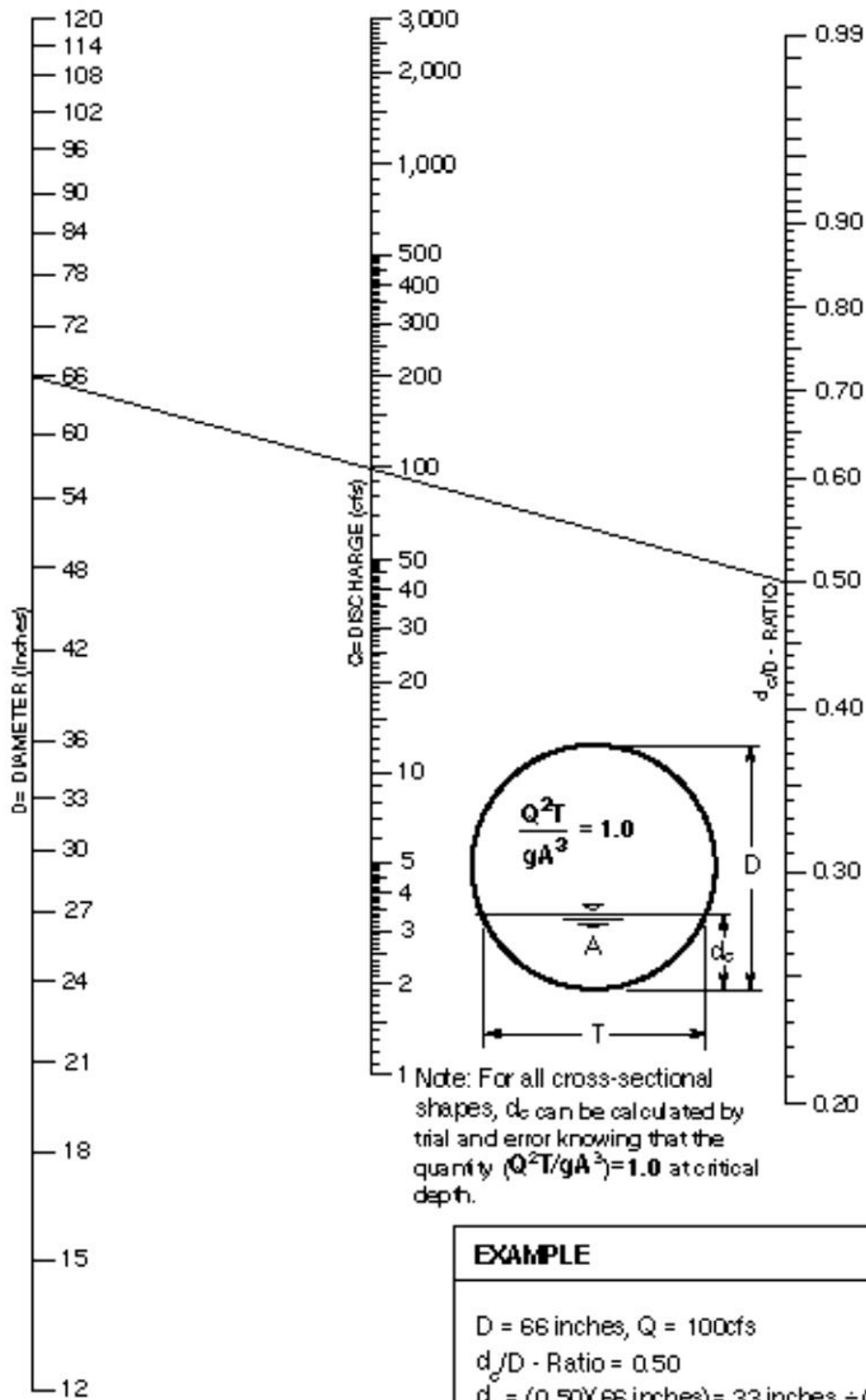


Figure F.11
 Head for Culverts (Pipe with $n=0.024$) Flowing Full with Outlet Control



1 Note: For all cross-sectional shapes, d_c can be calculated by trial and error knowing that the quantity $(Q^2 T / g A^3) = 1.0$ at critical depth.

EXAMPLE
D = 66 inches, Q = 100cfs d_c/D - Ratio = 0.50 $d_c = (0.50)(66 \text{ inches}) = 33 \text{ inches} \div (12 \text{ inches/ft})$ $d_c = 2.75 \text{ feet}$



Figure F.12
 Critical Depth of Flow for Circular
 Culverts

y	A	R	$R^{4/3}$	V	$\alpha V^3/2g$	E	ΔE	S_f	S_f	$S_o - S_f$	Δx	x
-1	-2	-3	-4	-5	-6	-7	-8	-9	-10	-11	-12	-13
6	72	2.68	3.72	0.42	0.0031	6.0031	-	0.00002	-	-	-	-
5.5	60.5	2.46	3.31	0.5	0.004	5.504	0.499	0.00003	0.000025	0.00698	71.5	71.5
5	50	2.24	2.92	0.6	0.0064	5.0064	0.4976	0.00005	0.00004	0.00696	71.49	142.99
4.5	40.5	2.01	2.54	0.74	0.0098	4.5098	0.4966	0.00009	0.00007	0.00693	71.64	214.63
4	32	1.79	2.17	0.94	0.0157	4.0157	0.4941	0.00016	0.000127	0.00687	71.89	286.52
3.5	24.5	1.57	1.82	1.22	0.0268	3.5268	0.4889	0.00033	0.000246	0.00675	72.38	358.9
3	18	1.34	1.48	1.67	0.0496	3.0496	0.4772	0.00076	0.000547	0.00645	73.95	432.85
2.5	12.5	1.12	1.16	2.4	0.1029	2.6029	0.4467	0.00201	0.001387	0.00561	79.58	512.43
2	8	0.89	0.86	3.75	0.2511	2.2511	0.3518	0.00663	0.00432	0.00268	131.27	643.7

The step computations are carried out as shown in the above table. The values in each column of the table are explained as follows:

- Col. 1. Depth of flow (ft) assigned from 6 to 2 feet
- Col. 2. Water area (ft²) corresponding to depth y in Col. 1
- Col. 3. Hydraulic radius (ft) corresponding to y in Col. 1
- Col. 4. Four-thirds power of the hydraulic radius
- Col. 5. Mean velocity (fps) obtained by dividing Q (30 cfs) by the water area in Col. 2
- Col. 6. Velocity head (ft)
- Col. 7. Specific energy (ft) obtained by adding the velocity head in Col. 6 to depth of flow in Col. 1
- Col. 8. Change of specific energy (ft) equal to the difference between the E value in Col. 7 and that of the previous step.
- Col. 9. Friction slope S_f , computed from V as given in Col. 5 and $R^{4/3}$ in Col. 4
- Col.10. Average friction slope between the steps, equal to the arithmetic mean of the friction slope just computed in Col. 9 and that of the previous step
- Col.11. Difference between the bottom slope, S_o , and the average friction slope, S_f
- Col.12. Length of the reach (ft) between the consecutive steps;
Computed by $x = E/(S_o - S_f)$ or by dividing the value in Col. 8 by the value in Col. 11
- Col.13. Distance from the beginning point to the section under consideration. This is equal to the cumulative sum of the values in Col. 12 computed for previous steps.



Figure F.14
Open Channel Flow
Profile Computation
(Example)



Example
Level Slope, Embedded Stone

$V = 8$ ft. per sec.
 $W = 6.5$ lbs.

$$V = y (2g)^{1/2} \left(\frac{w_r - w_w}{w_w} \right)^{1/2} (\cos \theta - \sin \theta)^{1/2} d_g^{1/2}$$

$$W = \frac{\pi}{6} d_g^3 w_r \text{ where } w_r = 165 \text{ lbs. per ft.}^3$$

$$w_w = 62.4 \text{ lbs. per ft.}^3$$

High Turbulence, use $W = 26$ lbs.

$d_g = 0.66$ ft. (8")

— Embedded Stone ($y = 1.20$)
- - - Non Embedded Stone ($y = 0.86$)

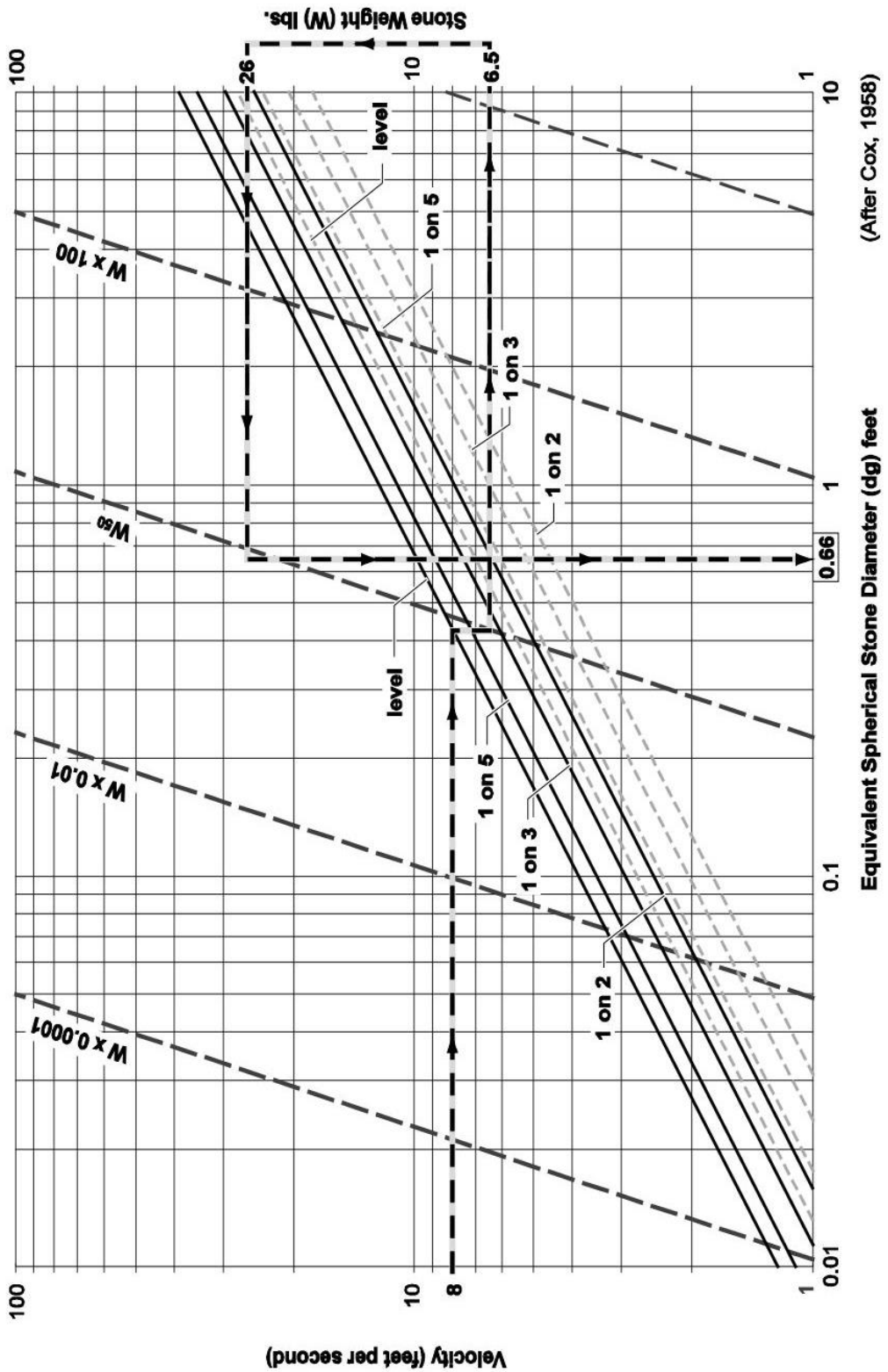


Figure F.15
Mean Channel Velocity vs
Medium Stone Weight and
Equivalent Stone Diameter

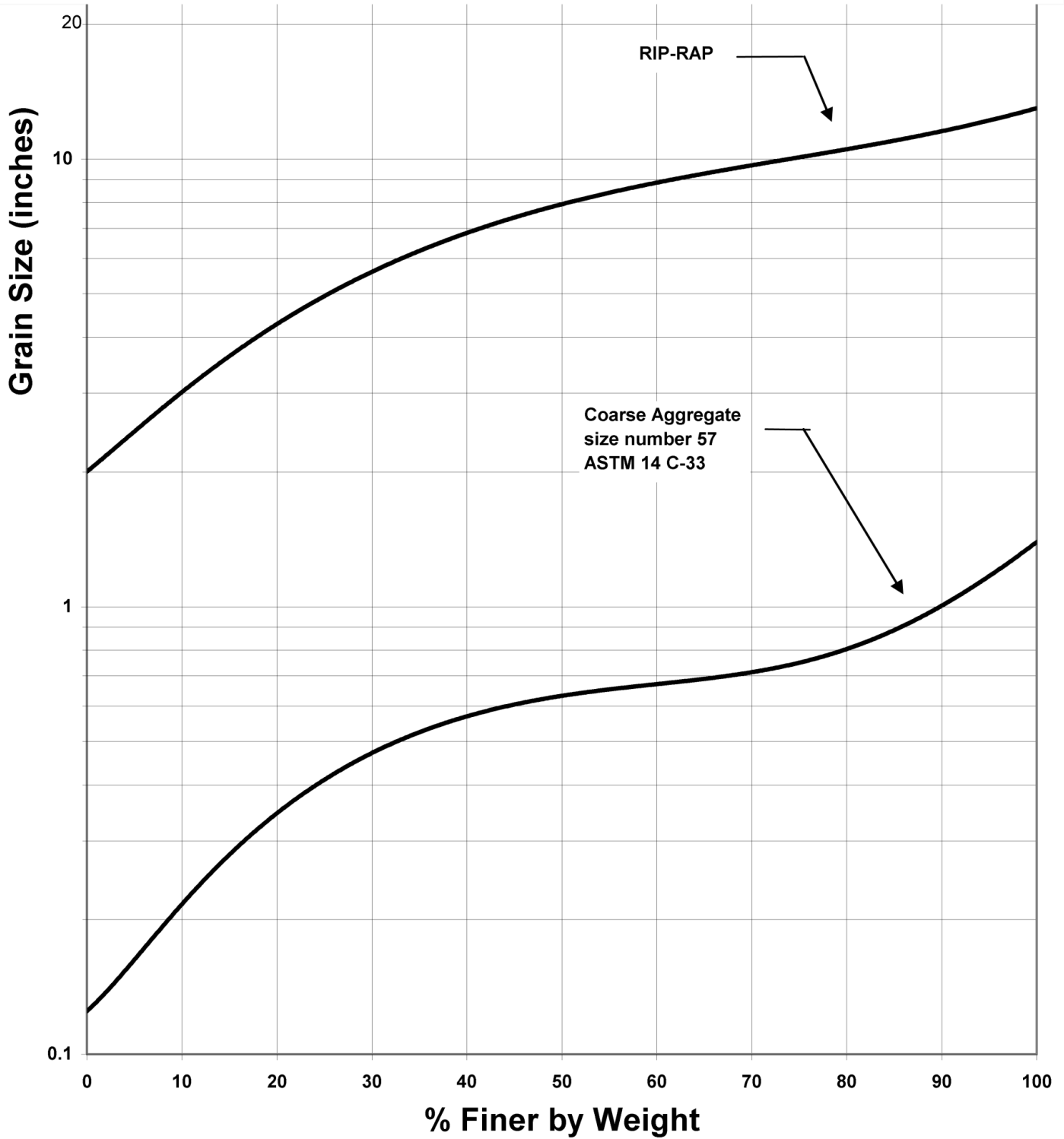


Figure F.16
Riprap/Filter Example Gradation
Curve